

Amtrak
Mechanical Department
Rolling Stock Equipment

SPECIFICATION

For

Long Distance Bi-Level Fleet Replacement

SPECIFICATION No. 1132

Issue Date: 12/22/2023
Revision No. 1

Approved By:

Date:

George Hull

12/22/2023

VP/Chief Mechanical Officer

David P. Byrnes

12/22/2023

AVP/DCMO Fleet Programs

Michael L. Kraft

12/22/2023

Director, Long Distance Fleet

Michael L. Kraft

12/22/2023

Originator & Creation Date

Table of Contents

1. SCOPE
2. REFERENCES AND GLOSSARY
3. PROJECT MANAGEMENT & REVIEWS
4. RELIABILITY, AVAILABILITY AND MAINTAINABILITY
5. QUALITY ASSURANCE
6. CARBODY
7. TRUCKS
8. COUPLERS AND DRAFT GEAR
9. BRAKES
10. HVAC SYSTEM
11. INTERIORS
12. DOOR SYSTEMS
13. LIGHTING SYSTEM
14. COMMUNICATION SYSTEM
15. ELECTRICAL SYSTEM
16. FOOD SERVICE
17. WATER AND WASTE SYSTEM
18. EMERGENCY EQUIPMENT
19. MATERIALS AND WORKMANSHIP
20. TEST REQUIREMENTS
21. TOOLS, CONSUMABLES AND SPARE PARTS
22. SHIPPING PREPARATION
23. TRAINING AND DOCUMENTATION
24. DIAGNOSTICS AND TEST EQUIPMENT
25. SAFETY
26. DIGITAL TECHNOLOGY
27. SOFTWARE AND MICROPROCESSOR-BASED SYSTEMS
28. CYBERSECURITY
29. ACCESSIBILITY

Amtrak Long Distance Bi-Level Fleet Replacement

Technical Specification

1. Scope

Revision 1

Table Of Contents

1.1	Overview.....	1-1
1.2	Regulations.....	1-1
1.3	Concept and Definition.....	1-2
1.4	Accessibility Requirements.....	1-4
1.5	Sustainability	1-5
1.6	Restroom and Bathroom Constraints	1-6
1.7	Car Type and Trainset Capacities.....	1-6
1.8	<i>Autotrain</i> Consist Solution (Option).....	1-6
1.9	Split Train Solutions (Option)	1-7
1.10	Amtrak Preliminary Trainset Concepts.....	1-8
1.11	Alternative Car Types (Options).....	1-17
1.12	Trainset Configurations.....	1-18
1.13	Consist Duty Cycle	1-21
1.14	Dimensions, Clearances and Track Geometry.....	1-21
1.15	Catenary Wire.....	1-23
1.16	Passenger Station Platforms.....	1-23
1.17	Environment	1-23
1.18	Technical Specification Section Summary	1-24
1.19	Standard Keys	1-33
1.20	Documentation Requirements.....	1-33
1.21	CDRLs.....	1-33

Table of Figures

Figure 1-1:	Minimum Accommodation Capacities	1-6
Figure 1-2:	Minimum Accommodation Capacities - <i>Autotrain</i>	1-7
Figure 1-3:	Standard Trainset Makeup.....	1-9
Figure 1-4:	Minimum Accommodation Capacities - Split Trains.....	1-10
Figure 1-5:	Conceptual Car Type Arrangement - End Coach	1-11
Figure 1-6:	Conceptual Car Type Arrangement – Standard Coach	1-11
Figure 1-7:	Conceptual Car Type Arrangement - Priority Coach	1-12
Figure 1-8:	Conceptual Car Type Arrangement - Diner	1-12
Figure 1-9:	Conceptual Car Type Arrangement - Café	1-13
Figure 1-10:	Conceptual Car Type Arrangement – First Class Lounge	1-13
Figure 1-11:	Conceptual Car Type Arrangement - Priority Sleeper.....	1-14
Figure 1-12:	Conceptual Car Type Arrangement - Standard Sleeper	1-14
Figure 1-13:	Conceptual Car Type Arrangement - Utility Car	1-15
Figure 1-14:	Capacities for Conceptual Car Type Arrangements	1-16

1.1 Overview

- a). The purpose of this Technical Specification is to define the performance and technical requirements for a fleet of new standard trainsets for use in Amtrak Long Distance network in North America.
- b). As defined in this specification, the Trainsets shall be delivered configured in a standard consist arrangement as well as a proposed optional solution for Amtrak's *Autotrain* (See Section 1.8).
 - i). Contractors are also being asked to propose a solution for trainsets which split enroute to provide service to two separate final destinations (See Section 1.9)
- c). Trainsets shall allow for the addition or removal of cars from trainsets should Amtrak's ridership dictate such seasonal changes.
- d). The Trainsets shall be used in locomotive hauled service and shall be compatible with Amtrak's current fleet of locomotives.
 - i). Trainsets may be operated with multiple locomotives at one end of the consist or locomotives at either end.
 - ii). Trainsets are primarily targeted for service with Amtrak's ALC-42 fleet but shall be designed to operate with any of Amtrak's legacy locomotives.
- e). The Trainsets shall allow Amtrak to operate throughout the United States of America and portions of Canada/Mexico. The Long Distance Bi-Level Fleet shall operate primarily in low platform territory.
- f). The Trainset will be composed of a combination of several types of Cars with different interior configurations.
- g). Technical characteristics and performance parameters for these Cars are described herein, as are the design review, inspection, testing and documentation requirements for producing and supporting these Trainsets.
- h). Accessibility and Universal Design for people with disabilities is a priority to Amtrak, and the U.S. has advanced and made progress in planning and incorporating them from the start. Amtrak strides to go beyond the ADA (and to some extent RVAAC) compliance. In other words, we're thinking of Universal Design as a norm. All accessibility features are critical for which Amtrak will not compromise.
- i). All design review, inspection, qualification and testing required by this contract shall be performed specifically for this contract. Reports from previous contracts or procurements will not be accepted.

1.2 Regulations

- a). The Trainsets must be fully compliant with all applicable United States Federal and Transport Canada regulations for safety, operations, design, accessibility, testing and materials standards.

- b). All cars of the Trainset shall be designed and constructed in accordance with Federal Railroad Administration and APTA design standards, to minimize passenger and train crew potential injuries in the event of collision.
- c). In addition, numerous industry standards, such as the APTA standards, are applicable as determined by Amtrak and referenced in this Specification.
- d). A complete listing of all regulations, standards, recommended practices and specifications that are referenced in this document can be found in Chapter 2.
- e). The list of referenced documentation in Chapter 2 is not to be interpreted as a comprehensive and exhaustive list of all regulations and standards to which the Contractor must adhere to in the design and manufacture of the Trainsets.
- f). The Contractor shall be solely responsible for complying with all standards, recommended practices and regulations that apply to the design and production of these Trainsets.

1.3 Concept and Definition

- a). For the purposes of this Specification, a Long Distance Trainset is defined as a collection of bi-level passenger cars which are coupled together to create a standard consist to be used for the provision of long distance service on an individual route or multiple service routes.
- b). A Car is defined as a single operational element which, when coupled with other cars, make up a trainset.
- c). The addition or removal of a Car from a consist shall be designed to minimize the time necessary for the change and shall not require access to a maintenance facility.
 - i). A planned reconfiguration shall be considered the removal or addition of car(s) for the adjustment of a trainset's capacity. The reconfiguration shall be considered complete when the adjusted trainset is ready for service. Planned configuration changes are intended to be seasonal one-time events and not a daily occurrence.
 - ii). An unplanned reconfiguration shall be considered the removal of a car due to an in-service failure for which the car must be set aside to allow the completion of the train's run. The reconfiguration shall be considered complete when the remaining trainset is ready for service and the failed car is set aside. Car designs are expected to add mitigations or redundancies so as this need is a minimal occurrence.
 - iii). Both a planned and unplanned reconfiguration must take less than 1 hour per car to complete given normal field conditions and without the use of special tools.
 - iv). After consist make-up, digital systems shall poll the cars in the new consist as required to automatically re-configure themselves for operation without

- manual intervention, including recognition of orientation of front and rear ends of the trainset.
- d). The two end cars shall be equipped with outboard facing standard H Type couplers.
 - i). Interconnections between intermediate cars within the Trainset shall be by means of coupled connections resulting in a trainset but allowing compliance with splitting consists as described in Sections 1.8 and 1.9.
 - e). The interconnections between intermediate cars shall be bridged with an open gangway with no less than 40" lateral open clearance. (See Chapter 6)
 - i). In the event of splitting adjacent cars, the open gangway shall incorporate a quick release that facilitates rapid uncoupling.
 - ii). The open gangway is intended to be enclosed and weather tight to prevent the intrusion of rain, snow and dirt from entering the passageway.
 - f). As defined in this Specification, the outermost cars of the core Trainset shall be configured with APTA standard couplers, air brake hoses and passenger car head end power.
 - g). To allow for operation with existing locomotives, trainsets shall be designed with Power/Communications/locomotive MU control electrical trainlines to allow the Trainsets to have interoperability with existing Amtrak locomotives.
 - h). This Specification does not require the Contractor to use any specific type of inter-car connections for intermediate cars within the Trainset, provided they comply with regulatory requirements and meet the performance requirements that are outlined in this Specification.
 - i). In locations where implemented, APTA standard couplers, air brake hoses, or passenger car Head End Power/Communications/locomotive MU control electrical trainlines, the connections must meet all applicable AAR, APTA, and Amtrak standards.
 - ii). Air and electrical connections must be configured to allow for rapid uncoupling.
 - i). The Trainsets must be designed and constructed to be suitable for unrestricted service anywhere within the United States of America and must comply with the Amtrak's Clearance Diagram, Bi-Level Passenger Car, Drawing Number 066-00050.
 - j). The Trainsets shall be designed, tested and qualified for bi-directional operation at a maximum speed of 110 mph and 4" cant deficiency.
 - k). Trainsets must also comply with all applicable sections of 49 CFR published by the Federal Railroad Administration (FRA) in effect at the time of Notice to Proceed.
 - l). The Trainset shall consist of vehicles containing several types of car arrangements. Consist arrangements will be further defined within this

CONFIDENTIAL — DO NOT DISTRIBUTE

Specification.

- m). Trainsets shall be designed with adequate storage for linens, cutlery, dishware, tools, and other necessary on-board equipment as required for the intended service and /or as specifically required by this specification.
- n). Details for the accommodations to be incorporated within the trainsets are presented in Chapter 11.

1.4 Accessibility Requirements

- a). Accessibility Compliance Expert
 - i). Throughout Design Review and Pilot Trainset production, the Contractor shall maintain an Accessibility Compliance Expert to support the design, functionality and implementation of all accessibility features.
 - ii). The Accessibility Compliance Expert may be a direct employee of the Contractor or a consultant but shall be a recognized expert in accessibility in the transportation industry.
 - iii). The Accessibility Compliance Expert shall participate in design reviews, mock-up evaluation, workshops and qualification testing.
 - iv). The Accessibility Compliance Expert shall be considered a key member of the Contractor's design team.
- b). In addition to compliance with the requirements of the ADA and other accessibility requirements in this specification, the Contractor shall comply with the terms of the Application for Equivalent Facilitation (EF) submitted by Amtrak and approved by the USDOT. (Exhibits R1 and R2)
- c). As submitted to FRA, the proposed Equivalent Facilitation requires:
 - i). Trainset / Semi-Permanent Coupling
 - (1) These Alternative Design Standards are based on the concept of an accessible core trainset offering enhanced mobility between cars and access to train amenities and utilizing semi-permanent coupling.
 - ii). Number of Accommodations
 - (1) The number of accessible coach spaces in a trainset will be equal to or greater than the number of coach cars in the trainset.
 - (2) The number of accessible bedrooms in a trainset will be equal to or greater than the number of sleeper cars in the trainset (not including sleeper cars used primarily for crews or other non-revenue purposes).
 - iii). Access to Amenities
 - (1) All accessible coach spaces and all accessible bedrooms will be located along or within an accessible core area of the trainset, with

- access to dining, café and lounge cars and similar amenities, via an accessible 32" wide path.
- (2) If or when accessible coach spaces or accessible bedrooms are located on the lower level of a bi-level car, access to amenities and redundant restrooms on the upper level will be via an accessible elevator, but such access may be more limited than for spaces and bedrooms on the upper level.
- iv). Priority Positions
 - (1) Accessible sleeper cars will have priority over any non-accessible sleeper cars in terms of proximity to dining, café and lounge cars.
 - (2) Accessible coaches will have priority over any non-accessible coaches in terms of proximity to dining, café and lounge cars.
 - v). Access to Redundant Restrooms
 - (1) All accessible spaces will have access to at least two accessible restrooms, via an accessible 32" wide path.
 - vi). Access to Redundant Vertical Access Points
 - (1) All accessible coach spaces and accessible bedrooms on the upper level of a bi-level train will have access, via an accessible 32" wide path, to at least two accessible elevators to provide access to the platform for boarding and deboarding.

1.5 Sustainability

- a). The Contractor shall develop and submit for Amtrak's review and approval a Type III environmental declaration per ISO 14025:2006(en), Environmental labels and declarations — Type III environmental declarations — Principles and procedures presenting quantified environmental information for the life cycle of a trainsets.
 - i). A draft declaration shall be submitted with the bid package with a revision during IDR. **[CDRL 1-01]**
 - ii). A final declaration shall be submitted for review and approval during FDR. **[CDRL 1-02]**
 - iii). It is noted that Type III environmental declarations, programs or their declarations are referred to by various names such as Eco-Leaf, eco-profile, environmental declaration of product, environmental product declaration (EPD) and environmental profile.
- b). As part of the design process, the Contractor shall work to minimize the onboard energy consumption per passenger-mile.
 - i). The efforts employed and the reduction in energy consumption shall be summarized in an energy consumption report to be submitted to Amtrak for review and approval as part of FDR. **[CDRL 1-03]**

1.6 Restroom and Bathroom Constraints

- a). In coach cars, a restroom shall be provided on both the upper and lower levels for every 32 seated passengers.
- b). In coach car levels with at least one accessible location, an accessible restroom must be provided.
- c). On levels with roomettes and/or SoloSuites, one communal shower must be provided for every 22 potential passengers in those accommodations.
- d). On levels with roomettes and/or SoloSuites, one restroom must be provided for every 15 potential passengers in those accommodations.
- e). All bedrooms and luxury bedrooms shall be equipped with private shower and restroom facilities, as described in Chapter 11.
- f). Accessible bedrooms shall be designed to comply with ADA requirements for passengers using a mobility device and shall be equipped with private shower and restroom facilities, as described in Chapter 11.
- g). Adjacent accessible bathrooms shall be no further than 150 feet apart on the upper accessible level.

1.7 Car Type and Trainset Capacities

- a). The Contractor shall optimize passenger and accommodation capacities, minimize the number of unique Car types, minimize consist length and comply with accessibility requirements of the CFR, this specification and the EF granted by the FRA.
- b). Amtrak will require car types and consists to be developed to meet capacities identified by consist.
- c). Car type and trainset makeup shall be developed to meet the following minimum accommodation capacities.

Figure 1-1: Minimum Accommodation Capacities

Projected Consist Length	Coach Seats	PremiumCoach Seats	Coach Accessible Locations	Diner Seating	Diner Accessible Locations	Lounge Seating	Lounge Accessible Locations	Cafe Seating	Cafe Accessible Locations	Accessible Twin	Accessible Double	Accessible Premium Bedroom	Club Bedrooms	Premium Bedrooms	Roomettes	SoloSuite	Crews Sleeper	Crew Break Table Seating	Crew Bathroom	Crew Shower	Conductor's Office	Baggage Car Volume
	850'	212	46	5	56	2	27	1	14	1	1	2	1	8	3	20	32	11	12	1	1	1

1.8 Autotrain Consist Solution (Option)

- a). The Contractor shall propose a trainset to address the current constraints required to support Amtrak’s *Autotrain* service.
- b). An *Autotrain* consist shall also be required, based on the same car types developed for the standard trainset.
- c). Minimum accommodation capacities for the *Autotrain* Trainset are as follows:

Figure 1-2: Minimum Accommodation Capacities - Autotrain

Projected Consist Length	Coach Seats	Premium Coach Seats	Coach Accessible Locations	Diner Seating	Diner Accessible Locations	Lounge Seating	Lounge Accessible Locations	Cafe Seating	Cafe Accessible Locations	Accessible Twin	Accessible Double	Accessible Premium Bedroom	Club Bedrooms	Premium Bedrooms	Roomettes	SoloSuite	Crews Sleeper	Crew Break Table Seating	Crew Bathroom	Crew Shower	Conductor's Office	Baggage Car Volume
1870'	212	46	5	112	4	27	1	14	1	3	4	3	24	7	40	96	17	12	1	1	1	TBD

- d). The *Autotrain* passenger cars operate in consist of up to 22 cars and coupled to as many as 35 car carrier autoracks.
- e). The *Autotrain* consist shall be able to be split (uncoupled) within 15 minutes allowing the two sections to be platformed at platforms no longer than 850' feet.
- f). The ability to split the consist shall in no way diminish any required ADA and EF requirements for accessibility between cars while the train is in-service and fully made-up.

1.9 Split Train Solutions (Option)

- a). In addition to *Autotrain*, Amtrak operates several trains that are split and coupled enroute.
- b). The Contractor shall propose the additional cars necessary to allow a standard consist to be extended allowing it to provide these split train operation requirements.
- c). The split train consist solutions shall be based on the same car types developed for the standard trainset.
- d). The ability to split the consist shall in no way diminish any required ADA and EF requirements for accessibility between cars while the train is in-service and fully made-up.
- e). The proposed solutions for each of the split trains shall be ADA and EF compliant in all legs.
- f). Split Train Requirements

- i). *Empire Builder*:
 - (1) Train operates as a single consist between Chicago, Illinois and Spokane, Washington.
 - (2) At Spokane, the consist is split with one sub-consist continuing to Seattle, Washington and the other sub-consist continuing to Portland, Oregon.
 - (3) The sub-consists are each coupled to a locomotive with a standard H Type coupler for the legs west of Spokane.
 - (4) At their respective destinations, the two sub-consists turn back and are recoupled to operate as one combined consist to Chicago.
 - (5) Spokane does not have any mechanical facilities – only two station tracks outdoors.
- ii). *Texas Eagle/Sunset Limited*
 - (1) The *Sunset Limited* operates as a single consist between Los Angeles, California and San Antonio, Texas.
 - (2) At San Antonio, one sleeping car and one coach are removed from the consist and coupled to the *Texas Eagle* consist bound for Chicago. The balance of the consist continues to New Orleans, Louisiana.
 - (3) On the return trip, the *Texas Eagle* operates from Chicago to San Antonio and the *Sunset Limited* operates from New Orleans to San Antonio.
 - (4) At San Antonio, one sleeping car and one coach are removed from the *Texas Eagle* consist and added to the *Sunset Limited* consist. The combined consist operates the rest of the way to New Orleans.
 - (5) The through cars that operate Los Angeles-San Antonio-Chicago do not reunite with the same consist in both directions.
 - (6) San Antonio does not have any mechanical facilities – only two station tracks outdoors.
- iii). The minimum accommodation capacities for the two Split Trains are presented in Figure 1-4.

1.10 Amtrak Preliminary Trainset Concepts

- a). In preparation for the creation of this specification, Amtrak internally developed a conceptual solution to detail car types and consist make-up to address the requirements, constraints and capacities for the required trainsets.
- b). These conceptual designs are presented for information only and should not be considered a fully compliant or optimized solution.

- c). Consideration of all or part of the conceptual car types or consist make-up does not relieve the Contractor of the requirement to meet all other requirements of this Contract and Technical Specification.
- d). Using the conceptual car types, the following (Figure 1-3) is a summary of the make-up of the Standard Trainsets.

Figure 1-3: Standard Trainset Makeup

Total Cars	End Coach	Standard Coach	Priority Coach	Diner	Café	Lounge	Priority Sleeper	Standard Sleeper	Utility Car
10	1	1	1	1	1	1	1	2	1

- e). The conceptual car type arrangements as shown in Figure 1-5, Figure 1-6, Figure 1-7, Figure 1-8, Figure 1-9, Figure 1-10, Figure 1-11, Figure 1-12, and Figure 1-13.
- f). The capacities for the conceptual car type arrangements are presented in Figure 1-14.

Figure 1-4: Minimum Accommodation Capacities - Split Trains

Trainset	Projected Consist Length	Standard Coach Seats	Premium Coach Seats	Coach Wheelchair Locations	Diner Seating	Diner Wheelchair Locations	Lounge Seating	Lounge Wheelchair Locations	Cafe Seating	Cafe Wheelchair Locations	Accessible Twin	Accessible Double	Accessible Premium Bedroom	Club Bedrooms	Premium Bedrooms	Roomettes	SoloSuites	Crew Sleepers	Crew Break Table Seating	Crew Bathroom	Crew Shower	Conductor's Office	Baggage Car Volume
Empire Builder																							
Chicago-Spokane	1360'	326	92	10	56	2	27	1	28	2	2	3	2	16	5	30	64	14	12	1	1	1	
Spokane-Seattle	850'	212	46	5	56	2	27	1	14	1	1	2	1	8	3	20	32	11	12	1	1	1	
Spokane-Portland	510'	114	46	5	0	0	0	0	14	1	1	1	1	8	2	10	32	3	12	1	1	1	
Texas Eagle / Sunset Limited																							
Los Angeles-San Antonio	425'	212	46	5	56	0	0	0	14	1	1	1	1	8	2	10	32	3	12	1	1	1	
San Antonio-New Orleans	595'	137	46	3	0	0	0	0	14	1	1	1	1	6	1	6	16	2	12	1	1	1	
San Antonio-Chicago	595'	212	46	5	56	2	0	0	14	1	1	1	1	6	1	6	16	2	12	1	1	1	

Figure 1-5: Conceptual Car Type Arrangement - End Coach

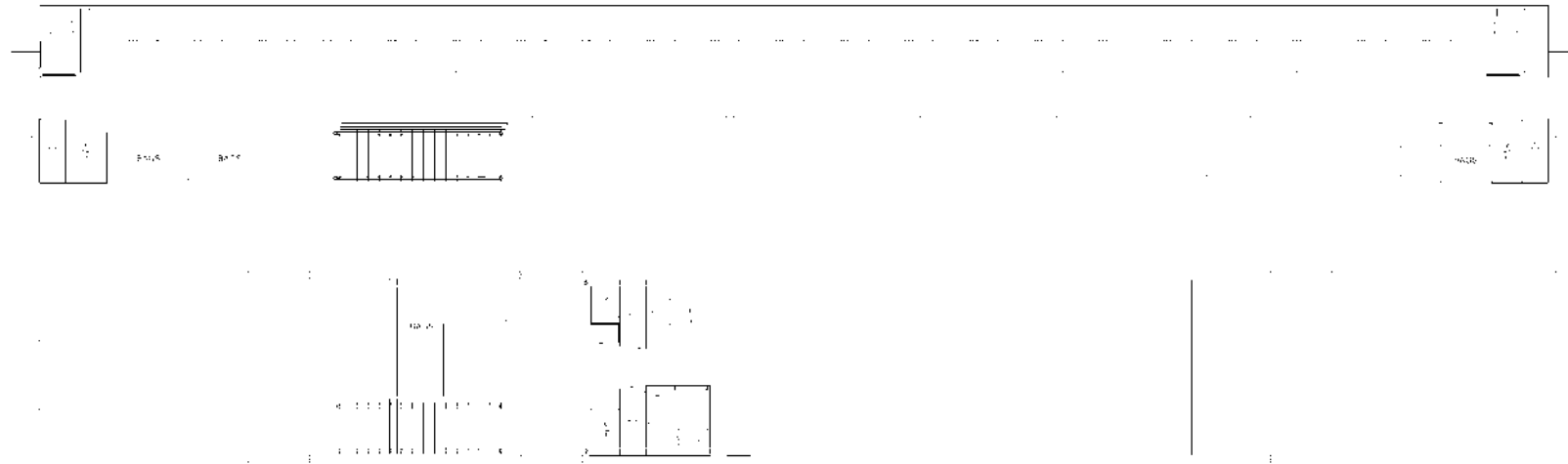

Figure 1-6: Conceptual Car Type Arrangement – Standard Coach

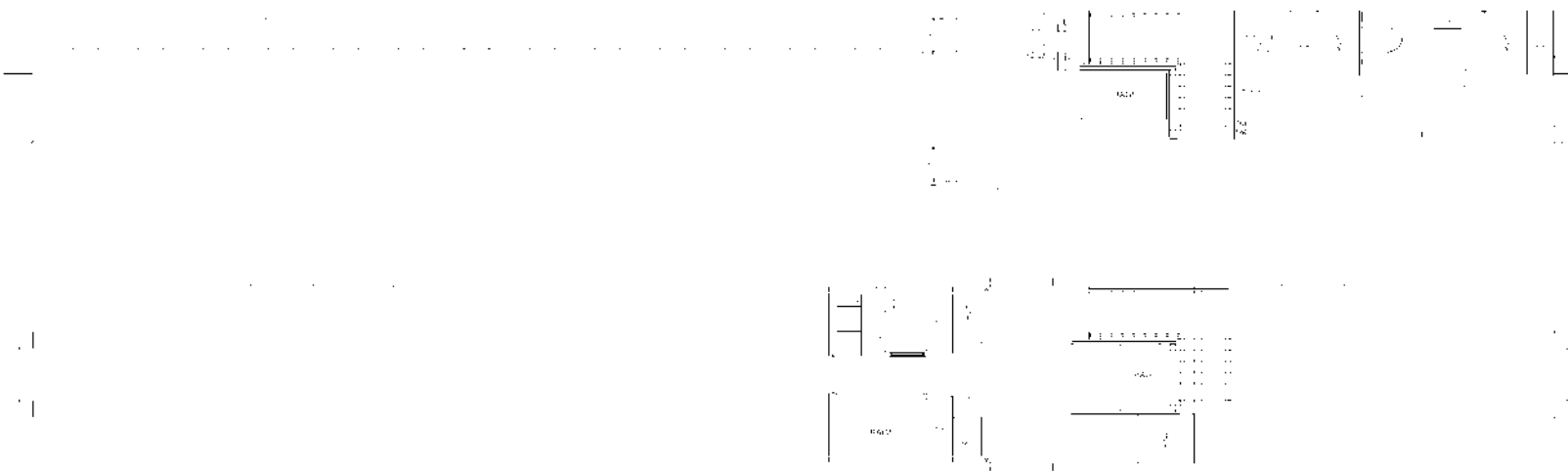

Figure 1-7: Conceptual Car Type Arrangement - Priority Coach

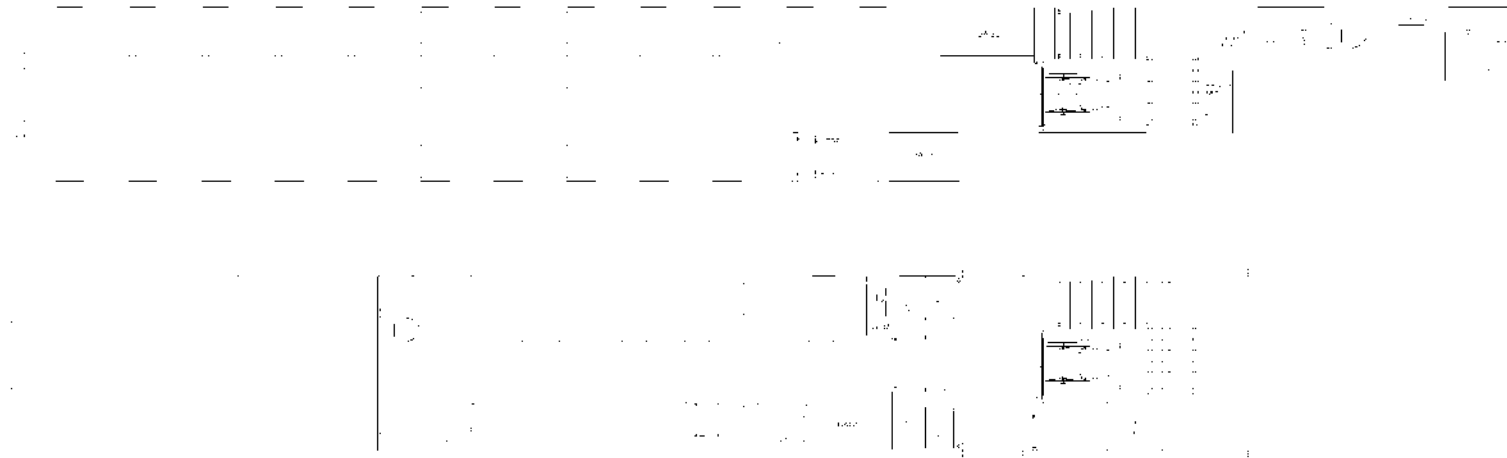

Figure 1-8: Conceptual Car Type Arrangement - Diner

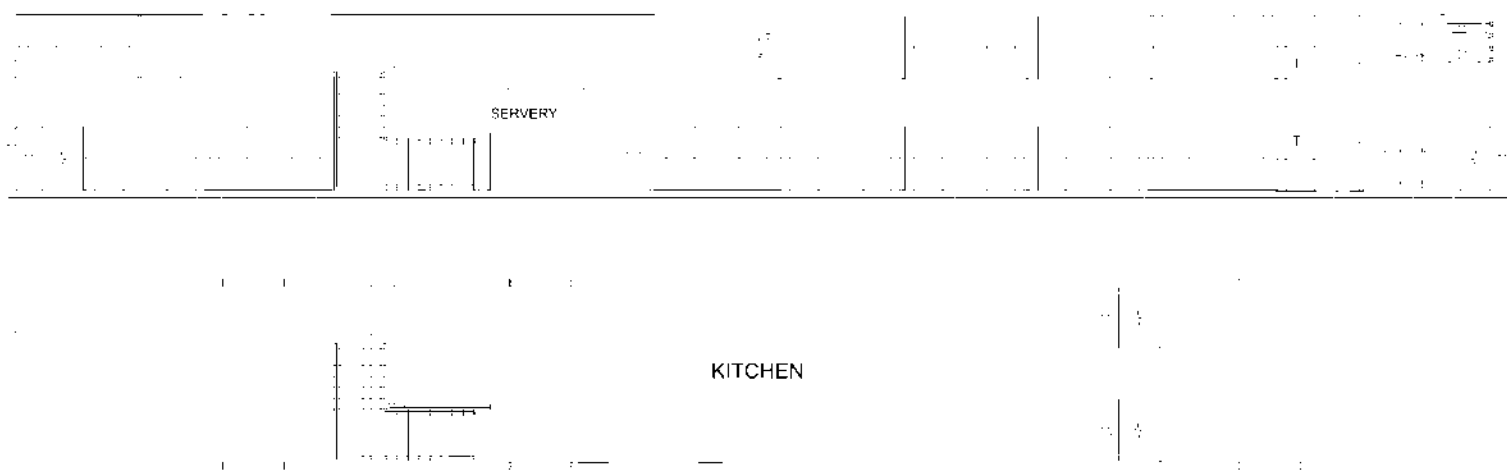

Figure 1-9: Conceptual Car Type Arrangement - Café

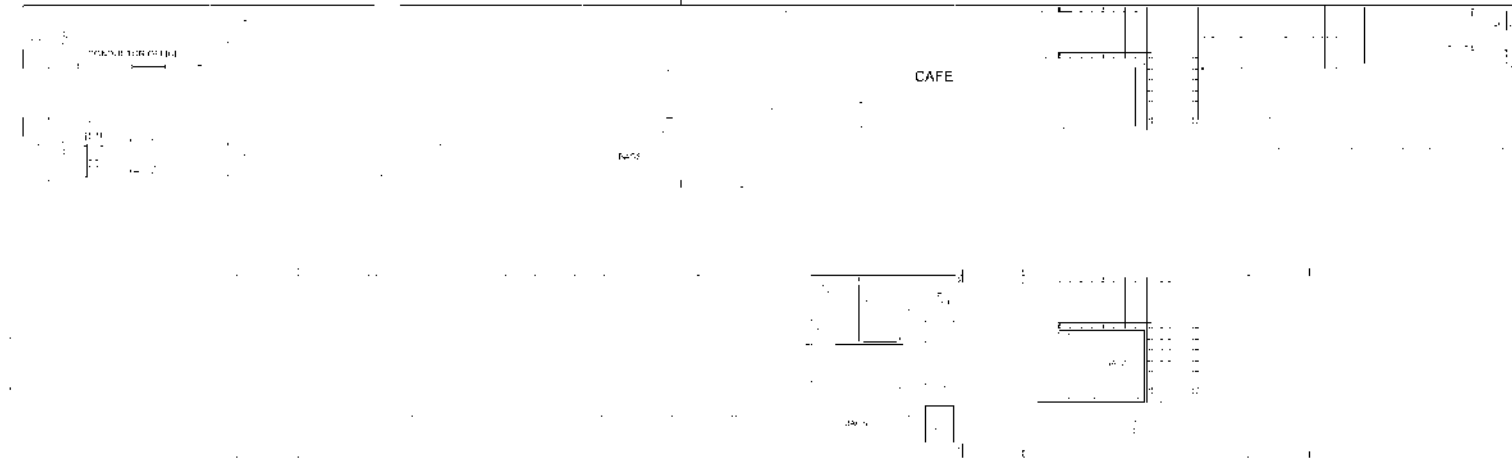

Figure 1-10: Conceptual Car Type Arrangement – First Class Lounge

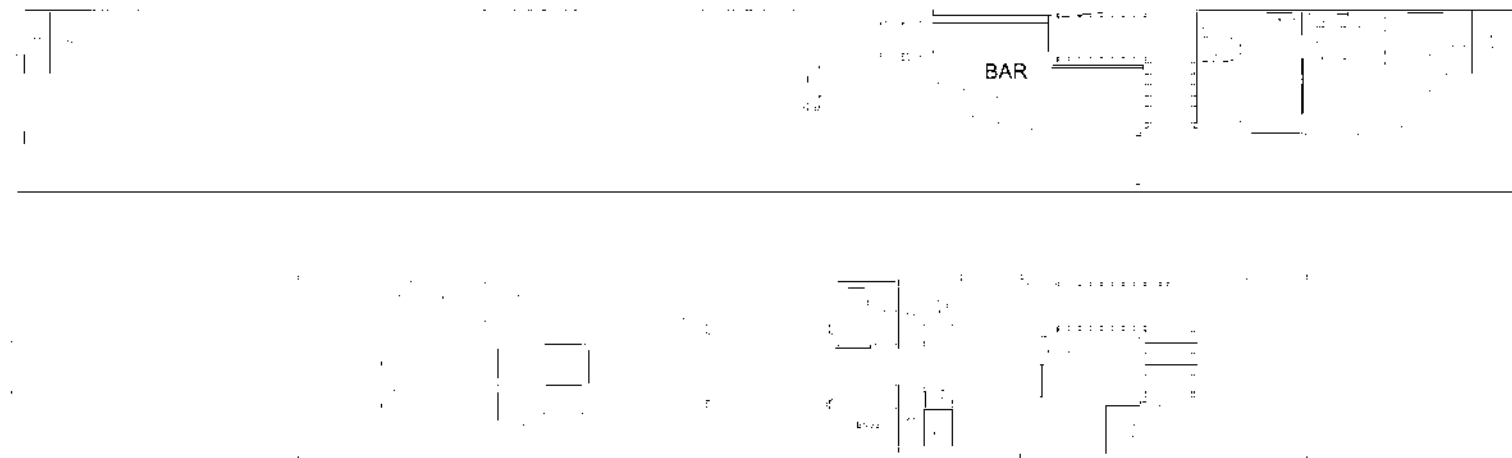

Figure 1-11: Conceptual Car Type Arrangement - Priority Sleeper

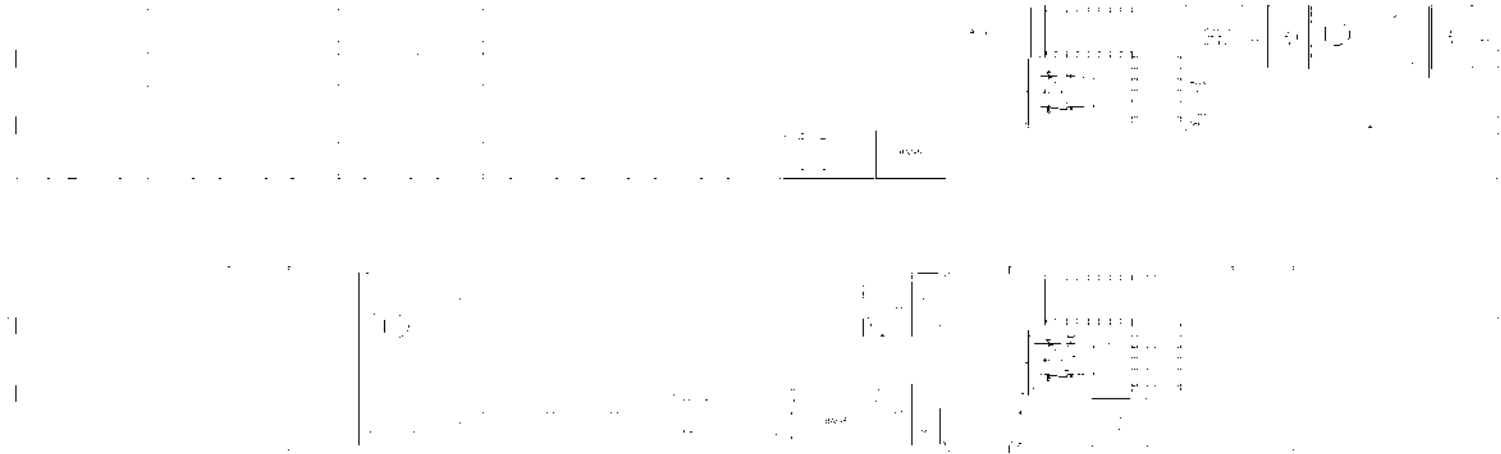

Figure 1-12: Conceptual Car Type Arrangement - Standard Sleeper

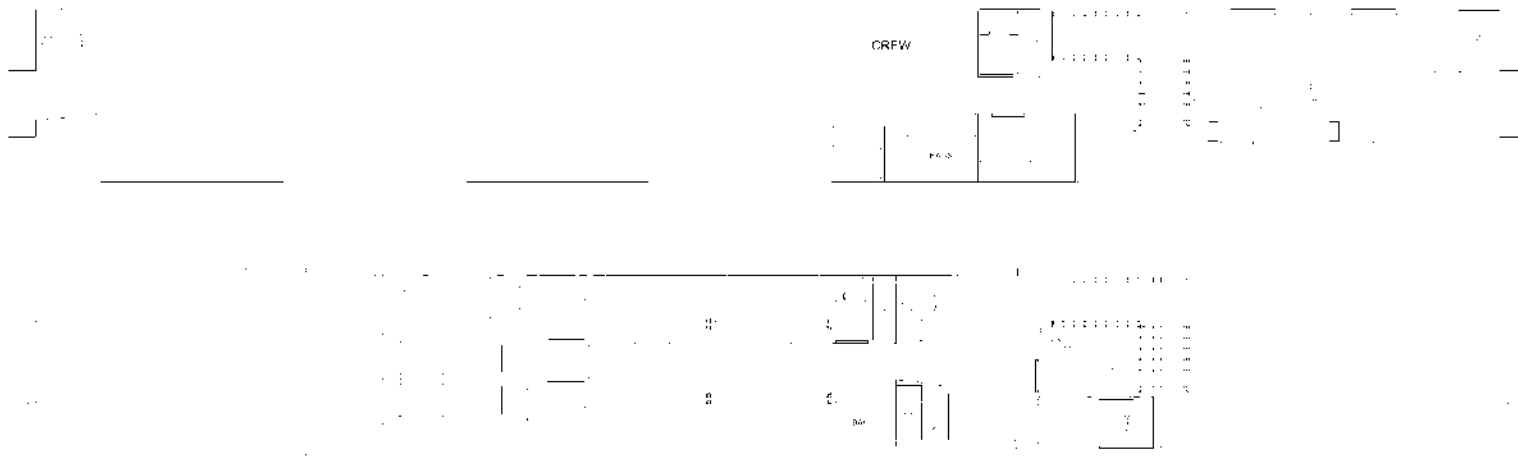

Figure 1-13: Conceptual Car Type Arrangement - Utility Car



Figure 1-14: Capacities for Conceptual Car Type Arrangements

	End Coach		Standard Coach		Priority Coach		Diner		Café		First Class Lounge		Priority Sleeper		Standard Sleeper		Utility Car		
	UL	LL	UL	LL	UL	LL	UL	LL	UL	LL	UL	LL	UL	LL	UL	LL	UL	LL	
2 x 2 Standard Seating (43" pitch)	70	28	51	24						24									
1 x 2 Premium Seating (48" pitch)	0	0	0	0	31	15			14										
Accessible Seating Locations	0	0	2	0	1	1													
Non-Accessible Restroom	2	1	0	1	0	0				1						1			
Accessible Restroom	0	0	1	0	1	1													
Aisle Width					32	32	32		32		32		32	32					
Diner Table Seating							56												
Diner Accessible Table Seating							2												
Food Service Area							1												
Full Kitchen								1											
Café Service									1										
2 x 2 Café Seating									14										
Accessible Café Seating Location									1	1									
2 x 2 x 2 table/lounge seating											27								
Accessible Lounge Seating Location											1								
Bar with Full Drink Service											1								
Premium Bedroom												1				1			
Roomette												4		2		4	6		
Common Bathroom												1		1	1	1	1		
Common Shower																		1	
Accessible Double Bedroom with Bathroom											1		1						
Accessible Twin Bedroom with Bathroom													1						
Club Bedroom with Bathroom													4		2				
Conductor's Room													1						
Accessible Premium Bedroom with Bathroom														1					
SoloSuite																16			
Crew Room																1			
Crew Sleeper																			8
Crew Table Seating																			12
Crew Bathroom																			1
Crew Shower																			1
#1 End Coupler	H		SP		SP		SP		SP		SP		SP		SP		SP		SP
#2 End Coupler	SP		SP		SP		SP		SP		SP		SP		SP		SP		H
Stairs	Y		Y		Y		Y		Y		Y		Y		Y		Y		Y
Passenger Elevator	N		N		Y		N		N		N		Y		N		N		N
Checked Baggage																			Y

CONFIDENTIAL — DO NOT DISTRIBUTE

1.11 Alternative Car Types (Options)

- a). In addition to the car types developed by the Contractor to address the capacity requirements of the standard trainsets and the Autotrain, the following alternative car types shall also be proposed as options:
 - i). Alternate Accessible Premium Coach
 - (1) Coupled at both ends
 - (2) Stairs between upper and lower levels
 - (3) Upper Level
 - (a) 1 x 2 Premium Seating (minimum 48" pitch) (minimum 29 passengers)
 - (b) Two accessible locations
 - (c) 1 accessible restroom
 - (d) 32" Aisles
 - (4) Lower Level
 - (a) 2 x 2 Standard Seating (minimum 43" pitch) (minimum 23 passengers)
 - (b) One non-accessible restroom
 - ii). Bedroom Sleeper
 - (1) Coupled at both ends
 - (2) Stairs between upper and lower levels
 - (3) Upper Level
 - (a) Six Bedrooms with bathrooms
 - (b) One Crew Room
 - (4) Lower Level
 - (a) Four Roomettes
 - (b) One Luxury Queen Room
 - (c) One Conductor's Roomette
 - (d) One Common Bathroom
 - (e) 1 Restroom

1.12 Trainset Configurations

- a). All pneumatic trainlines, Head End Power (HEP) trainline, communications/door control trainline and push-pull trainline functionality shall be provided when coupled to other Amtrak cars and locomotives.
 - i). All cars shall be fully compatible for unlimited duration movement when locomotive pulled or pushed, or when coupled to conventional freight cars as in a freight train.
- b). Trainsets shall be designed and arranged for walkable access along the entire length of the trainset through the interior of the upper level.
- c). Designs shall be modular to the extent practical, to minimize the amount of additional design required to adapt cars to future service class/type needs.
 - i). Carshell structures and attachment points of interior fixtures shall be designed to permit any service type defined in this Specification to be converted to any other service type defined in this Specification without requiring modifications to the carbody.
 - ii). The vehicle design shall provide Amtrak with flexibility to configure the vehicle arrangement to suit the applicable service route, including the ability to replace modules to adapt furnishings such as: luggage tower, bicycle storage, Micro-Market equipment, vending equipment, coach seating assemblies, business seating assemblies, and tables or booth seating.
- d). The carbody and all its structural elements, including trucks and running gear, shall have a minimum design life of 40-years of operation at full seated passenger load.
 - i). The design and selection of materials shall prevent corrosion damage, including the effects of extreme weather conditions, during the 40-year design life.
- e). Safety, reliability and maintainability shall be primary performance goals for the Trainsets and shall be incorporated into the design and design review process.
 - i). Use of specialized tools, hardware, or equipment shall be minimized.
 - ii). Any specialized tools, hardware or equipment needed for maintenance shall be included as a special tool deliverable with the first trainset.
 - iii). Ease of access for inspection, maintenance and repairs shall be a major design consideration.
 - iv). To ensure a trainset can complete its full journey without needing to set a car out enroute, system redundancies and debris strike hardening shall be implemented in all aspects of the design of the trainset.
 - v). All entrance areas shall be weather resistant to the extent that no water or snow intrusion can accumulate in those areas and must be properly mitigated when the side loading doors are open.

- vi). All designs shall be capable of operating with wayside scanning for visual analysis to determine wear conditions and/or running gear component failures.
- f). Components used on this equipment shall be identical and interchangeable across the entire production run.
 - i). Components shall not be drilled or sized to fit.
 - ii). Components shall not be paired or married to a parent assembly without the specific review and approval by Amtrak.
- g). In addition to the overall concept described above, the design and construction of the Trainsets shall also address the following:
 - i). Each car shall have a mid-car doorway on the lower level.
 - ii). Where components have been specified by manufacturer and part number in this Specification, the Contractor may propose alternate manufacturers' components, for review and approval by Amtrak.
 - (1) Proposed alternative components must be functionally interchangeable with components called out herein.
 - (2) For safety critical items, introduction of alternative components will only be considered if such components have an established performance record in intercity passenger service, and/or have undergone an appropriate qualification program that demonstrates an acceptable level of safety, serviceability and reliability for passenger cars. This documentation shall be submitted to Amtrak for review and approval.
 - (3) Acceptance of proposed alternative components shall be solely at the discretion of Amtrak.
 - iii). Design reviews shall be employed to assess all proposed designs for compliance with specification requirements including safety, maintainability, ergonomics, functionality, and passenger comfort.
 - (1) Specific requirements for the design review process are described in Chapter 3.
 - iv). Design reviews shall be supported by virtual and physical mock-ups. The mock-ups will allow Amtrak and its representatives to review the configuration and layout of the proposed design, to experience the workability, comfort, access and functionality and to fine-tune the design for maximum benefit.
 - (1) Specific requirements for the provision of mock-ups are provided in Chapter 3.
 - v). Passenger Experience and Industrial Product Design Authority

- (1) The Contractor shall focus on design aspects including but not limited to aesthetics, customer experience, functional design, usability, interaction, ergonomics and comfort reviews.
- (2) Amtrak has developed a Product Vision Package which addresses:
 - (a) Passenger accommodation design
 - (b) Car Type Layout
 - (c) Color, Material and Finish (CMF) application
 - (d) External Livery (in process)
 - (e) Overall implementation of the preceding to achieve Amtrak's overall vision of the final product.
- (3) In the course of the design process, the Contractor shall have the following design authority and constraints:
 - (a) The Contractor shall comply with the design of the accommodations and arrangement of cars to comply with the required functionality and overall trainset capacity.
 - (b) Throughout the Passenger Experience and Industrial Product Design, the Contractor shall provide details with regard to color material and finish (CMF) to ensure the final accepted product design successfully delivers against Amtrak's brand palette, long distance brand DNA and the unique experience and spaces on our long-distance trains as is detailed in the Customer Experience Vision Package (Exhibits F, F1 and F2).
 - (c) At the start of Preliminary Design Review, Amtrak will provide the Contractor with its conceptual vision for the exterior livery of the trainsets. The Contractor should expect to work collaboratively with Amtrak throughout the design review process to arrive at a final livery design during Final Design Review.
 - (d) The Contractor shall be responsible for working collaboratively with Amtrak throughout the Passenger Experience and Industrial Product Design Review Process to successfully implement Amtrak's overall Product Vision.
- vi). Materials and workmanship shall meet the requirements of Chapter 19, and all equipment shall be designed to operate in the environmental conditions specified in Amtrak Specification 963.
- vii). As detailed in this chapter, the Contractor shall develop proposals, renderings, and a comprehensive package for color palettes, storyboards, layout arrangements, interior materials, and exterior graphics for approval or modification by Amtrak.

- (1) The features, components, layouts, graphics and customization of the cars shall be selected by Amtrak during design reviews.
 - viii). Amtrak shall provide unit numbers, reporting marks, and naming no less than 12 months after notice to proceed.
 - h). Prior to the initiation of the design review process, the Contractor and Amtrak shall jointly discuss the implementation of a Rapid Prototype Process which will help streamline the validation of the production process and the subsequent completion of the pilot trainset.
- 1.13 Consist Duty Cycle
- a). Trainsets shall be designed for continuous operation for up to 72 hours and 1200 miles per day.
- 1.14 Dimensions, Clearances and Track Geometry
- a). Carbody dimensions and weights
 - i). The cars shall be designed and built to conform to the following overall AW0 weight limitations:
 - (1) A static axle load of no more than 38,500 lbs.
 - (2) Track dynamic (P2) forces per axle shall be limited to 68,000 lbs., calculated using the formula and parameters defined in Chapter 7.
 - (3) The Trainsets shall be weighed at the Contractor's facility, and shall have weight distribution and balance as follows:
 - (4) End-to-end balance of cars within 5% (both at full supplies and no supplies).
 - (5) Lateral balance (side to side) of all cars within 5% (both at full supplies and no supplies)
 - b). Length
 - i). Trainsets may be configured in consists up to 1,870 ft in length.
 - ii). Trainsets of maximum length may be operated in consist with up to 35 Amtrak Car Carriers.
 - iii). All trainset functions shall operate per the standards of this specification within this train length range, except as noted below, including but not limited to trainline, communications, power, and carbody strength.
 - iv). Trainline functions may operate at reduced levels (tolerance to be approved by Amtrak) at consist lengths greater than 1870 ft (due to trainline voltage drop).

- v). The brake system shall be designed for normal operation at all consist lengths up to 1870 ft in total length, excluding any locomotive(s).
- c). Clearances
 - i). The Trainsets shall fully conform to Amtrak's Clearance Diagram, Bi-Level Passenger Car, Drawing Number 066-00050 under all operating conditions.
 - ii). The Clearance Drawing is based upon the assumption that a car is nominally 85 ft long with truck center spacings of 59.5 ft.
 - iii). No carbody-mounted appliances shall extend beyond the clearance envelope.
- d). Track Geometry
 - i). The Trainsets shall be designed, tested and certified for revenue operation at all speeds up to 110 mph.
 - ii). The Trainsets shall be designed, tested and certified for operation on all classes of track (per 49 CFR Part 213) from FRA Class 1 to Class 8, at the maximum allowable speed on each class of track.
- e). Trainsets shall be qualified and capable of dead-in-tow operation at speeds up to 90 mph and 3" cant deficiency.
- f). Track quality shall be assumed to be minimally compliant for each class of track, per FRA regulations and AREMA standards.
- g). Ride quality standards and testing methods are specified in Chapters 7 and 20.
- h). The Trainsets shall operate on standard gauge (56.5 in.) track.
- i). The braking performance of the Trainset shall comply with Chapter 9 and Amtrak braking performance drawing S-603.
- j). The Trainsets shall be capable of negotiating a 250 ft radius (23 degree) horizontal curve, coupled to other equipment, without damage to the track or any portion of the Trainset, including trucks and suspension, couplers, draft gears, air and electrical connections, diaphragms or carbody.
- k). The Trainsets shall be capable of negotiating a 2000 ft radius vertical curve (concave or convex), coupled to other equipment, without damage to the track or any portion of the Trainset, including trucks and suspension, couplers, draft gears, air and electrical connections, diaphragms or carbody.
- l). The Trainsets shall be dynamically stable at all speeds up to and including 5 mph above maximum design speed.
- m). No wheel of the Trainset shall experience more than 50% wheel unloading when the train is stopped on a 7 in. super-elevation.
- n). The Trainsets shall be capable of operating at a minimum of 4 in. cant deficiency,

without requiring tilt, according to 49 CFR Part 213.329.

- o). The Trainsets shall be capable of safely passing other trains that are operating at maximum authorized track speed in either direction on adjacent tracks with 12 ft centers.
- p). The Trainsets shall be capable of negotiating a number 8 crossover between two tracks with 12 ft centers and a number 7 crossover between two tracks with 13 ft centers, coupled to other equipment, without damage or separation of any inter-car connections including air hoses and electrical connectors.
- q). The Trainsets shall be capable of negotiating facing number 8 turnouts per Amtrak Drawing No. AM 73195-A arranged to form a "S" curve with a minimum of 5 feet of tangent between switch points, coupled to other equipment, without damage or separation of any inter-car connections including air hoses and electrical connectors.
- r). The Trainsets shall be capable of negotiating two 400-foot radius reverse curves with zero tangent in-between, coupled to other equipment, without damage or separation of any inter-car connections including air hoses and electrical connectors.

1.15 Catenary Wire

- a). The Trainsets shall be immune to the effects of any electrical interference from 12 kV and 25 kV catenary systems, including induced electrical currents into the carbody and potential ground return currents through the trucks and wheelset journal bearings.

1.16 Passenger Station Platforms

- a). The Trainsets shall be designed to serve low level boarding station platforms.
 - i). Low level station platforms may be either below Top of Rail, at Top of Rail, 8 inches above Top of Rail and 61 inches from centerline of track, or 15 inches above Top of Rail and 64 inches from centerline of track.
 - ii). Many of the at or below TOR platforms are controlled by freight railroads who will protect their clearances. Careful consideration must be provided for these platforms as well.

1.17 Environment

- a). The Trainset design shall comply with the environmental requirements of Amtrak Specification 963.
- b). The equipment shall be designed and built for use in the long-distance passenger rail environment.
- c). Special considerations for the high humidity and salt content in the air from the coastal marine areas, excessively fine dust, and from freezing temperatures to high temperatures exceeding 125°F (51.7°C) shall be incorporated into the design.

- d). To the maximum extent possible, exterior equipment, cables, hoses and pipes shall be protected against debris strikes. Each mitigation, however, will need to be balanced with negative impacts to maintainability and shall be submitted to Amtrak for review and approval during the design review process.

1.18 Technical Specification Section Summary

- a). Specification Summary (Chapter 1)
 - i). This Chapter
- b). References and Glossary (Chapter 2)
 - i). Presents a summary of acronyms, definitions and references used throughout this specification.
- c). Project Management (Chapter 3)
 - i). Presents Project Management requirements for schedule management, drawings, document control, Design Review, mock-ups and other program support functions.
- d). Reliability, Accessibility and Maintainability (Chapter 4)
 - i). Presents the Reliability, Availability, and Maintainability (RAM) requirements, including analysis and other submittal requirements.
- e). Quality Assurance (Chapter 5)
 - i). Presents the Contractor quality, manufacturing and inspection requirements for the fleet design and production. The Contractor is expected to have an overall Quality Assurance Program that is implemented throughout their organization and a project specific Project Quality Plan.
- f). Carbody (Chapter 6)
 - i). Presents the requirements for the design and manufacture of the vehicles' carbody. Includes specifics on structural compliance.
 - ii). Carbody materials shall conform to APTA standards and recommended practices.
 - iii). The Trainset shall provide crashworthiness performance consistent with Chapter 4 of this Specification.
 - iv). The carbody shall:
 - (1) Be fully compliant with FRA Tier I requirements for structural strength and testing per 49 CFR Part 238, including alternate compliance if required.
 - (2) Feature large picture windows.

- (3) Include carborne mounted mobility device lifts at appropriate entries intended for ADA access.
- g). Trucks (Chapter 7)
 - i). The Trainset equipment shall be capable of operations up to 110 mph and 4 in. cant deficiency and shall be certified as such per applicable sections of 49 CFR
 - ii). Truck design shall be proven for safe and reliable operation on all FRA classes of track up to and including Class 8.
 - iii). Cast or fabricated trucks are permitted under this specification.
- h). Coupler and Draft Gear (Chapter 8)
 - i). Couplers at the end of the Trainset shall be designed to couple with conventional US rolling stock and motive power.
 - ii). Couplers, coupler carriers, uncoupling mechanisms and drawbar connections, including articulations, shall be compliant with FRA applicable requirements and APTA standards.
 - iii). Any car with semi-permanent draft gear shall allow the substitution of standard H-type couplers, allowing Amtrak maximum flexibility of consist arrangement.
- i). Brakes (Chapter 9)
 - i). The Trainset shall be equipped with electronically controlled pneumatic (ECP) braking systems. The braking systems shall include an ECP system for service and emergency brake applications, a wheel slide control system and a parking brake for all cars in the Trainset.
 - ii). The Trainset air brake equipment shall be completely compatible with Type 26C/26L air brake equipment currently in use in intercity rail passenger service and be capable of operating in conventional train service in graduated release or direct release mode.
 - iii). Nominal air pressures in the air brake system shall be:
 - (1) Main Reservoir: 140 psig
 - (2) Brake Pipe: 110 psig
 - (3) Brake Cylinder: 100 psig maximum
 - iv). Disc and/or tread brake units shall be installed on all axles. If disc brake alone system braking capacity is sufficient, wheel scrubbers shall be provided.
 - v). Microprocessor-based wheel slide protection provided on all axles and controlled on a per-truck or per axle basis.

- vi). Individual cars in the Trainset shall be equipped with a hand or parking brake.
- j). Heating, Ventilation and Air Conditioning (Chapter 10)
 - i). The equipment shall be designed for operation under the environmental conditions described in Amtrak Specification 963.
 - ii). The Heating, Ventilation and Air Conditioning (HVAC) system will use energy efficient compressors, environmentally friendly refrigerants, microprocessor controls and multiple temperature sensors for system operation.
 - iii). Bedrooms shall provide individual temperature adjustments for passengers.
 - iv). The HVAC systems shall be hermetically sealed, packaged units.
 - (1) Complete changeout of an HVAC unit shall be possible within 2 hours, making use of quick disconnects, etc.
 - v). Redundant systems shall provide cooling and fresh air tempering to all parts of the Trainset occupied by passengers.
 - vi). The HVAC system shall maintain the train interior within design temperatures at all ambient conditions.
 - vii). Maximum interior sound levels are specified to limit blower and diffuser noise.
 - viii). Filters shall be easy to access and replace from inside the car and/or ground level of the exterior without the use of any specialized equipment.
 - ix). Water and door system components shall be equipped with freeze protection.
- k). Interiors (Chapter 11)
 - i). Trainsets shall include various car arrangements as necessary to comply with the trainset capacity requirements detailed in this chapter, Chapter 11 and the Customer Experience Vision Package.
 - ii). All cars shall be fully equipped with emergency signage and Low-Level Exit Path Markings (LLEPM), in conformance with APTA standards and FRA requirements.
 - iii). Interior design shall be developed by the Contractor to successfully implement the overall vision presented in this specification and the attached Customer Experience Vision Package (Exhibits F, F1 and F2).
 - iv). Interior design concepts and deviations from the Customer Experience Vision Package (Exhibits F, F1 and F2) shall be presented to Amtrak during the design review process for review and shall be accepted solely at Amtrak's discretion.

- v). The Contractor shall provide renderings and mock-ups as required in Chapter 3.
 - vi). To the extent feasible, coach seats and tables shall be mounted in adjustable tracks for easy installation, and to facilitate changes in seat pitch or interchangeable with other seating or storage configurations at the discretion of Amtrak.
- l). Door Systems (Chapter 12)
- i). The side of each car of the trainset shall have exterior side entrance doors, capable of low-level station platform boarding.
 - ii). Side doors throughout the Trainset shall be capable of being remote controlled from any door control station located on the same side of the train and can also be operated individually. Alternative designs may be considered subject to Amtrak review and approval.
 - iii). The door system shall comply with all FRA and APTA safety provisions.
 - iv). Side doors shall feature convenient access for maintenance of door operator hardware.
 - v). All doors shall have exterior side door crew key switches for employee access.
 - vi). Exterior side doors in each accessible car shall include a mobility device lift with accessibility to an elevator to the upper level. An alternative design may be proposed for the onboard mobility device lift that minimizes or eliminates the need for the lift while still providing the ability to load a passenger with a wheeled mobility device onto the train.
 - vii). Bedroom doors shall feature locks which can be unlocked via RFID.
 - viii). Each side access door shall incorporate a gap filler to minimize excessive space between the door threshold and the platform.
 - ix). An option proposal shall be provided for manually operating side doors.
- m). Lighting (Chapter 13)
- i). Interior lighting shall utilize Light Emitting Diodes (LEDs) for energy efficiency and reliability.
 - ii). Private accommodation lighting shall be adjustable by the passenger.
 - iii). All LED passenger lighting shall be powered from the battery system.
 - iv). Emergency lighting system shall have independent power source back-up.
 - v). The normal and emergency lighting systems shall meet all APTA standards and FRA requirements for charging of High Pressure Photoluminescent

(HPPL) and Low-Level Emergency Path Marking (LLEPM) material and emergency light levels.

- n). Communication System (Chapter 14)
 - i). All cars in the Trainset will feature a Public Address (PA) system, train crew intercom, digital trainline, and OTIS.
 - ii). PA and intercoms shall be compliant with FRA requirements for emergency communication.
 - iii). Specifications for passenger Wi-Fi and OTIS shall be consistent with Amtrak nationwide standards for these systems.
- o). Electrical (Chapter 15)
 - i). Primary power source is Trainset or locomotive provided 480 Volt Alternating Current (VAC) Head End Power (HEP).
 - ii). The power distribution system shall convert the HEP to all required voltages for use throughout the Trainset.
 - iii). The battery and battery charger system provide the low-voltage power supply for systems requiring power when HEP is lost (PA, door operators, lights).
 - iv). Each end of each Trainset car will be equipped with Amtrak standard trainlines to allow the Trainset to be connected to locomotives and/or conventional equipment when necessary:
 - (1) 480VAC HEP trainline (in compliance with APTA Recommended Practice PR-E- RP-016-99)
 - (2) 27-Point locomotive Multiple Unit (MU) trainline (in compliance with APTA Recommended Practice PR-E-RP-017-99)
 - (3) 27-Point communication (COMM) trainline (in compliance with APTA Recommended Practice PR-E-RP-017-99)
 - (4) Receptacles will be located on both sides of each end of the Trainset cars to provide maximum flexibility in building train consists (either end of any Trainset can be connected to either end of any other Trainset or car).
 - v). 120VAC utility outlets shall be located in all restroom rooms, equipment rooms, electrical lockers and utility rooms, for ease of maintenance and cleaning.
 - vi). A Digital communications trainline shall be provided.
- p). Food Service (Chapter 16)
 - i). Trainsets shall include:

- (1) Diner
- (2) Coach Café
- (3) First Class Lounge
- ii). Food Service areas shall comply with all applicable Food and Drug Administration (FDA) regulations.
- iii). The Diner shall include a full service food preparation kitchen
- q). Water and Waste System (Chapter 17)
 - i). Fresh water shall be provided for restrooms, nominal convenience functions, and food service.
 - ii). Particulate and antibacterial filtration will be used to provide potable water on the trainset.
 - iii). All black wastewater shall be captured and stored in a waste retention tank of sufficient capacity.
 - iv). Onboard sanitation of potable water systems shall be possible through an Ozone disinfection system.
 - v). Freeze protection systems shall be provided, along with automatic drain protection valves.
 - vi). Gray water shall be processed on-board and reused as toilet flush water.
- r). Emergency Equipment (Chapter 18)
 - i). Individual units/cars within a Trainset shall be equipped with emergency equipment as required by the FRA and Transport Canada.
 - ii). Signage for the emergency equipment shall meet all applicable FRA requirements.
- s). Materials and Workmanship (Chapter 19)
 - i). All materials, parts and workmanship used in the manufacture of the Trainsets are subject to rigorous standards for quality, performance, method of assembly and compliance with applicable regulations and industry standards.
- t). Test Requirements (Chapter 20)
 - i). The Trainsets shall undergo extensive testing as prescribed in the Specification, to ensure that they meet all requirements for design, performance and quality.
 - ii). Four major categories of tests are specified:

- (1) Material certifications
 - (2) Proof of design tests
 - (3) Production tests
 - (4) Acceptance tests
- u). Tools and Consumables (Chapter 21)
- i). This chapter outlines the requirements for tools, consumables and spare parts for use by Amtrak on the Trainset.
- v). Shipping Preparation (Chapter 22)
- i). This chapter outlines the requirements for preparing for shipping of each Trainset to Amtrak.
- w). Documentation and Training (Chapter 23)
- i). Support documentation, such as maintenance and operating manuals, as-built drawings, parts lists and troubleshooting guides, shall be provided.
 - ii). A training program shall be established for familiarizing operating, mechanical and supervisory staff on the proper maintenance, repair, troubleshooting and operation of the equipment.
 - iii). A training program shall be established for Amtrak Police Department and Emergency Response personnel.
 - iv). The training program shall also be available as a recorded presentation to be available on a web site determined by Amtrak.
- x). Diagnostics and Test Equipment (Chapter 24)
- i). Each car within the Trainset shall be provided with a diagnostic and fault reporting system. Alternate designs may be proposed for Amtrak approval.
 - ii). Fault and diagnostic information from all applicable sub-systems shall be available in a simplified version to the on-board crew, in full detail for maintenance, and shall be available remotely.
 - iii). The system shall be capable of real-time data recording.
 - iv). Remote temperature monitoring shall be provided as a semi-independent portion of the CDU.
 - v). Various diagnostic test equipment (DTE) for maintenance shop use shall be supplied.
- y). Safety (Chapter 25)

- i). The Contractor shall conduct a Safety Program throughout the program and shall support Amtrak in the performance of a Safety Certification Program.
 - ii). The Contractor shall develop, implement and maintain a comprehensive System Safety Program Plan
 - iii). The Contractor shall provide a Preliminary Hazard List, a Preliminary Hazard Analysis and a Hazard Tracking Log.
 - iv). The Contractor shall provide a comprehensive FMECA(s) for all components on the vehicle.
 - v). The Contractor shall provide a quantifiable Fault Tree Analysis for all Category/Severity one and two hazards.
 - vi). The Contractor shall submit a subsystem hazard analysis for each vehicle subsystem.
 - vii). The Contractor shall submit an Operating and Support Hazard Analysis (O&SHA) to identify and assess hazards introduced during system operation, maintenance, and support activities.
 - viii). The Contractor shall implement a Hazard Resolution Process for the evaluation and control of the severity and probability of a potentially hazardous event.
- z). Digital Technology (Chapter 26)
- i). Amtrak shall be provided with direct access to on-board and off-board information in near-real-time via machine-to-machine communications, with as little human involvement as possible.
 - ii). In the rare circumstance of a railway incident, Amtrak has a statutory obligation to provide information to regulatory authorities in support of their post-incident investigative activities.
 - iii). Contractor shall provide a secure, robust and standardized Application Programming Interface (API)-based Information Technology platforms to facilitate Amtrak access to all data generated by and for the rolling stock, its onboard systems, as well as any and all wayside components of this contract.
 - iv). These APIs shall provide standardized integration points between any car and Amtrak's systems for the purpose of onboarding and offboarding information.
 - v). These APIs shall facilitate Amtrak design and development of all aspects of the customer experience solutions within its own content management and other programming facilities.
 - vi). The rolling stock and its systems shall support receiving content updates via these Amtrak systems or intermediary vendor services via APIs.

- vii). The Amtrak system shall be capable of retrieving telemetry, performance, events and other data from the trains or intermediary vendor services via APIs on a push, request, and near real-time basis.
- aa). Software and Microprocessor (Chapter 27)
 - i). This Chapter applies to all software, microprocessor-based systems supplied for this project, including vehicle subsystem controls, test equipment, data analysis, fault analysis and training deliverables.
 - ii). This Chapter includes the requirements for the non-Commercial Off the Shelf (COTS) software development process.
 - iii). The Contractor, as system and software integrator, shall be responsible for the overall quality of all software supplied as part of this contract. If the Contractor also develops software, it shall consider the team that develops software as a supplier.
 - iv). The Chapter defines the requirements for Software development, testing, configuration control, documentation and delivery.
- bb). Cybersecurity (Chapter 28)
 - i). Defines cybersecurity requirements for all hardware, software, software services and firmware (hereinafter referred to as the "products" for purposes of this section) to be provided under this Contract, whether resident within a microprocessor-controlled system, provided as part of test or interface equipment, provided for the purpose of post-download data analysis and processing, incorporated within training technology and manuals, Bench Test Equipment (BTE) or supplied as a part of a software based service.
 - ii). The NIST SP 800-53 Framework shall be used as the underlying risk management framework to identify, detect, protect from, respond to and recover from security risks associated with the trainset over its lifecycle, evolving to maintain concurrency with current versions.
 - iii). The Contractor shall conduct a thorough assessment of all entities involve in its collective underpinning
 - iv). All personnel performing work related to the development, operation, or maintenance of the equipment supplied as a part of this technical specification shall undergo adequate security training.
- cc). Accessibility (Chapter 29)
 - i). Presents a summary of the accessibility requirements incorporated throughout the specification.
- dd). TSSSA (Exhibit G)
 - i). Presents the scope of services to be provided by the Contractor under the Technical Support and Spares Supply Agreement ("TSSSA").

- ii). The TSSSA includes Technical Support for all maintenance activities as well as materials management and supply, including but not limited to procurement, inventory planning, delivery, and quality assurance.
- iii). The TSSSA requires the Contractor to support Amtrak’s implementation of the Maintenance Plan provided as part of the provision of Long Distance trainsets.

1.19 Standard Keys

- a). A total of two types of standard keys shall be used on the various car types, a coach (Conductor’s) key and a maintenance key, along with provisions in the Food service car galley for use of crew-supplied padlocks.

1.20 Documentation Requirements

- a) All documents shall, as a minimum, contain the following:
 - a). A title page with a clear and concise title block, which includes all pertinent references to the Contract and an accurate description of enclosed information.
 - b). Display approval signatures of the original document on the title page to serve as an easy reminder of the approval signatures required for all future revisions.
 - c). Display Amtrak’s contract number on the title page.
 - d). Display the originating company's name and address on the title page.
 - e). Display the overall revision level on the title page and display the varying revision level on each consecutive page.
 - f). Display the unique document number on each page of the document.
 - g). Record the specific changes of a revision on a dedicated page that includes space for new approval signatures for that revision without requiring the removal of previous approval signatures.
 - h). Record the revision levels of individual pages on a dedicated page for verification of proper document composition.
 - i). Contain a table of contents and an itemized listing of tables and figures.

1.21 CDRLs

CDRL	Description	Due
CDRL 1-01	Draft Type III Environmental Declaration	30 days prior to 1 st IDR Meeting
CDRL 1-02	Final Type III Environmental Declaration	30 days prior to 1 st FDR Meeting
CDRL 1-03	Energy Consumption Report	30 days prior to 1 st FDR Meeting

Amtrak Long Distance Bi-Level Fleet Replacement

Technical Specification

2. References and Glossary

Revision 1

Table of Contents

2.1	Overview.....	2-1
2.2	Supplemental Regulations, Standards, Specifications and Drawings.....	2-1
2.3	Regulations.....	2-1
2.4	Standards.....	2-5
2.5	Definitions.....	2-16
2.6	Acronyms and Abbreviations	2-29

2.1 Overview

- a). Regulations, standards and specifications that are referenced in this document are listed below as a guide to the Contractor but shall not be construed as complete.
- b). The Contractor is responsible for ensuring that all applicable regulations, standards and specifications in effect at time of Award are followed when complying with the requirements of this specification.
- c). Nothing in this specification shall relieve the Contractor from ensuring that all applicable regulations, standards and specifications are followed. The Contractor shall provide the Compliance Matrix required by Chapter 3 as proof of compliance for those items so governed before the first trainset is accepted.

2.2 Supplemental Regulations, Standards, Specifications and Drawings

- a). Regulations, standards, specifications and drawings, which may pertain to this specification, are listed below as information. The following list is furnished as a guide to the Contractor but shall not be construed as complete or actually used. When any of the following are superseded by an approved revision, the revision shall apply.
- b). Unless specified otherwise, the Contractor shall be responsible for acquiring and maintaining copies of all applicable references from the appropriate source.
 - i). Amtrak shall not be obligated to provide these referenced documents unless specifically stated.
 - ii). The Contractor will be responsible for determining if there are newer versions of the referenced specifications/regulations/standards and obtaining them.

2.3 Regulations

- a). ADA (Americans with Disabilities Act)
 - i). 36 CFR 1192.99: Floors, Steps and Thresholds
 - ii). 36 CFR 1192.113: Doorways
 - iii). 36 CFR 1192 Appendix: Advisory Guidelines
 - iv). 49 CFR Subtitle A, Figure 4: Intercity Rail Car (with accessible restroom)
 - v). 49 CFR 38.101: Lighting
 - vi). 49 CFR 38.117: Floors, Steps and Thresholds
 - vii). 49 CFR 38.123: Restrooms
 - viii). 49 CFR 38.125: Mobility and Accessibility
 - ix). 49 CFR 38.159: Mobility Aid Accessibility

CONFIDENTIAL — DO NOT DISTRIBUTE

- x). Americans with Disabilities Act of 1990 and regulations promulgated thereafter, including 49 CFR 27, 37 & 38.
- xi). Rail Vehicle Accessibility Advisory Committee (RVAAC) of the United States Access Board
- b). Canadian Transport Commission
 - i). General Order O-10: Railway Safety Appliance Standards
- c). DOE (U.S. Department of Energy)
 - i). Energy Policy Act (EPAAct) of 2005
- d). EPA (Environmental Protection Agency)
 - i). Title 40:
 - (1) Part 40 CFR Protection of Environment
 - (2) Part 82: Protection of Stratospheric Ozone
 - (3) Part 201: Noise Emission Standards for Transportation Equipment; Interstate Rail Carriers
 - (4) Part 1033: Control of Emissions from Locomotives
- e). FAA (U.S. Federal Aviation Administration)
 - i). AC 43.13-1A, Section 449: Stripping Insulation
- f). FDA (U.S. Food and Drug Administration)
 - i). 21 CFR 1250: Interstate Conveyance Sanitation
 - (1) 1250.41: Submittal of Construction Plans
 - ii). 2017 U.S. Food & Drug Administration: Food Code
 - iii). Handbook of Sanitation of Railroad Passenger Cars, 1964
- g). FRA (Federal Railroad Administration)
 - i). 14 CFR 25.853: Compartment Interiors
 - ii). 21 CFR Part 1250: Interstate Conveyance Sanitation
 - iii). Title 49, 49CFR Transportation, Section II, Parts 200-299
 - iv). 210: Railroad Noise Emission Compliance Regulations
 - v). 213: Track Safety Standards

- (1) 213.329: Curves, Elevation and Speed Limitations
- vi). 213.333: Automated Vehicle Inspection Systems
- vii). 213.345: Vehicle Qualification Testing
- viii). 213.57: Curves; Elevation and Speed Limitations
- ix). 221: Rear End Marking Device-Passenger, Commuter and Freight Trains
- x). 222: Use of Locomotive Horns at Public Highway-Rail Grade Crossings
- xi). 222.21: When Must a Locomotive Horn be Used?
- xii). 223: Safety Glazing Standards--Locomotives, Passenger Cars and Caboosees
- xiii). 231: Railroad Safety Appliance Standards
- xiv). 236: Rules, Standards, and Instructions Governing the Installation, Inspection, Maintenance, and Repair of Signal and Train Control Systems, Devices, and Appliances
- xv). 236 Subpart I: Positive Train Control Systems
- xvi). 238: Passenger Equipment Safety Standards
 - (1) 238.103: Fire Safety
 - (2) 238.105: Train Electronic Hardware and Software Safety
 - (3) 238.107: Inspection, Testing and Maintenance Plan
 - (4) 238.111: Pre-revenue Service Acceptance Testing Plan
 - (5) 238.112: Door Emergency Egress and Rescue Access Systems
 - (6) 238.113: Emergency Window Exits
 - (7) 238.114: Rescue Access Windows
 - (8) 238.115: Emergency Lighting
 - (9) 238.121: Emergency Communication
 - (10) 238.123: Emergency Roof Access
 - (11) 238.131: Exterior Side Door Safety Systems
 - (12) 238.205: Anti-Climbing Mechanism
 - (13) 238.207: Link Between Coupling Mechanism and Car Body

- (14) 238.215: Rollover Strength
- (15) 238.217: Side Structure
- (16) 238.219: Truck-to-Carbody Attachment
- (17) 238.227: Suspension System
- (18) 238.231: Brake System
- (19) 238.233: Interior Fittings and Surfaces
- (20) 238.235: Doors (Emergency Egress)
- (21) 238.303: Exterior Calendar Day Mechanical Inspection of Passenger Equipment
- (22) 238.307: Periodic Mechanical Inspection of Passenger Cars and Unpowered Vehicles Used in Passenger Trains
- (23) 238.435: Interior Fittings and Surfaces
- (24) 238.441: Emergency Roof Access
- (25) 238 Appendix B: Test Methods and Performance Criteria for the Flammability and Smoke Emission Characteristics of Materials Used in Passenger Cars and Locomotive Cabs
- (26) 238 Subpart B: Safety Planning and General Requirements
- (27) 238 Subpart C: Specific Requirements for Tier 1 Passenger Equipment
- xvii). 239: *Passenger Train Emergency Preparedness*
 - (1) 239.101: Emergency Preparedness Plan
 - (2) 239.107: Emergency Exits
- xviii). 243: Training, Qualification, and Oversight for Safety-Related Railroad Employees
- xix). 571.208, Subpart 6: Federal Motor Vehicle Safety Standards: Occupant Crash Protection
- h). FTA (Federal Transit Administration)
 - i). FTA-PA-27-5194-12.1: Quality Management System Guidelines
- i). Transport Canada
 - i). TC O-0-10: Installation of Air Reservoirs
 - ii). TC O-0-16: Railway Passenger Handling Safety Rules

- iii). TC O-0-26: Passenger Car Safety Rules
- iv). TC O-0-76: Locomotive Safety Rules
- v). TC O-07-01: Passenger Train Brakes
- j). USPHS (U.S. Public Health Service)
 - i). U.S. Public Health Service Food Code 2017

2.4 Standards

- a). AAMA (American Architectural Manufacturers Association)
 - i). 501.1-05: Standard Test Method For Water Penetration Of Windows, Curtain Walls And Doors Using Dynamic Pressure
- b). AAR (Association of American Railroads)
 - i). C-II: Design, Fabrication, and Construction of Freight Cars
 - ii). M-101: Axles Carbon Steel, Heat-Treated
 - iii). M-107/M-208: Wheels, Carbon Steel
 - iv). M-114: Helical Springs, Heat-Treated Steel
 - v). M-201: Steel Castings
 - vi). M-601: Hose, Wrapped, Air Brake, "End Hose"
 - vii). M-618: Hose, Air, Wire-Reinforced
 - viii). M-1001: Design, Fabrication, and Construction of Freight Cars
 - ix). RP-585: Wiring and Cable Specification
 - x). S-100, Section B: Bushings, Stainless Steel Tube–Coupler Shanks and Yokes
 - xi). S-400: Brake Equipment-Installation Specifications
 - xii). S-471: Brake Pipe Restriction Test
 - xiii). S-4200: ECP Cable-based Brake Systems – Performance Specifications
 - xiv). S-4210: ECP Cable-based Brake System Cables, Connectors and Junction Boxes – Performance Specifications
- c). AHRI (Air-Conditioning, Heating, and Refrigeration Institute)
 - i). 700: Specifications for Fluorocarbon Refrigerants

- d). Aluminum Association
 - i). AA-ADM-105: Aluminum Design Manual: Specifications and Guidelines for Aluminum Structures
 - ii). Aluminum Company of America (ALCOA) Technical Report 524, Specification Covering Use of Aluminum in Passenger Carrying Railway Vehicles
 - iii). Aluminum Standards and Data
- e). ANSI (American National Standards Institute)
 - i). B16.18: Cast Copper Alloy Solder Joint Pressure Fittings
 - ii). C82.2: For Lamp Ballasts-- Method of Measurement of Fluorescent Lamp Ballasts
 - iii). S1.4: Specification for Sound Level Meters
 - iv). S3.2-2009: Method for Measuring the Intelligibility of Speech over Communication Systems
 - v). Z26.1: Safety Code for Safety Glazing Materials for Glazing Motor Vehicles Operating on Land Highways
- f). ANSI (American National Standards Institute)/ASME (American Society of Mechanical Engineers)
 - i). B1.1: Unified Inch Screw Threads (UN and UNR Thread Form)
 - ii). B1.13M: Metric Screw Threads
 - iii). B16.22: Wrought Copper and Copper Alloy Solder-Joint Pressure Fittings
 - iv). B18.1.2: Large Rivets (1/2 Inch Nominal Diameter and Larger)
 - v). B31.1: Power Piping
- g). ANSI (American National Standards Institute)/IEEE (Institute of Electrical and Electronics Engineers)
 - i). 730: Software Quality Assurance Plans
 - ii). 1016: IEEE Standard for Information Technology-Systems Design-Software Design Descriptions
 - iii). C37.13: IEEE Standard for Low-Voltage AC Power Circuit Breakers Used in Enclosures
 - iv). C37.14: IEEE Standard for DC (3200V and below) Power Circuit Breakers Used in Enclosures

- v). C37.16: Low-Voltage Power Circuit Breakers and AC Power Circuit Protectors
- h). APTA (American Public Transportation Association)
 - i). Passenger Rail Equipment Safety Standards (PRESS) for Rail Programs
 - ii). Manual for the Development of System Safety Program Plans for Commuter Railroads
 - iii). Manual of Standards and Recommended Practices for Rail Passenger Equipment
- i). ASHRAE (American Society of Heating, Refrigeration and Air Conditioning Engineers)
 - i). 41.1-1986 (R2006): Standard Method for Temperature Measurement
 - ii). 37-2009: Methods of Testing for Rating Electrically Driven Unitary Air-Conditioning and Heat Pump Equipment
 - iii). 23-2016: Guideline for the Design and Application of Heating, Ventilation, and Air-Conditioning Equipment for Rail Passenger Vehicles
- j). ASME (American Society of Mechanical Engineers)
 - i). Boiler and Pressure Vessel Code
 - ii). Code for Pressure Piping
 - iii). B1.13M: Metric Screw Threads: M Profile
- k). ASTM (American Society for Testing and Materials)
 - i). A6: Standard Specification for General Requirements for Rolled Structural Steel Bars, Plates, Shapes, and Sheet Piling
 - ii). A53/A53M-07: Standard Specification for Pipe, Steel, Black and Hot-Dipped, Zinc-Coated, Welded and Seamless
 - iii). A380-06: Standard Practice for Cleaning, Descaling, and Passivation of Stainless Steel Parts, Equipment, and Systems
 - iv). A488/A488M-07: Standard Practice for Steel Castings, Welding, Qualifications of Procedures and Personnel
 - v). A502-03: Standard Specification for Rivets, Steel Structural
 - vi). A572, A 568, A 588, A 606, A 715, A 710: High Strength Low Alloy Structural Steel
 - vii). A588: Standard Specification for High-Strength Low-Alloy Structural Steel

- viii). A606: Standard Specification for Steel, Sheet and Strip, High-Strength, Low-Alloy, Hot-Rolled and Cold-Rolled, with Improved Atmospheric Corrosion Resistance
- ix). A666: Standard Specification for Annealed or Cold-Worked Austenitic Stainless Steel Sheet, Strip, Plate, and Flat Bar
- x). A710: Standard Specification for Precipitation-Strengthened Low-Carbon Nickel-Copper-Chromium-Molybdenum-Columbium Alloy Structural Steel Plates
- xi). A715: Standard Specification for Steel Sheet and Strip, High-Strength, Low-Alloy, with Improved Formability
- xii). A802: Standard Practice for Steel Castings, Surface Acceptance Standards, Visual Examination
- xiii). B26/B26M-09: Standard Specification for Aluminum-Alloy Sand Castings
- xiv). B32-08: Standard Specification for Solder Metal
- xv). B75-02: Standard Specification for Seamless Copper Tube
- xvi). B85/B85M-09: Standard Specification for Aluminum-Alloy Die Castings
- xvii). B108/B108M: Standard Specification for Aluminum-Alloy Permanent Mold Castings
- xviii). B117: Standard Practice for Operating Salt Spray (Fog) Apparatus
- xix). B247-09: Standard Specification for Aluminum and Aluminum-Alloy Die Forgings, Hand Forgings, and Rolled Ring Forgings
- xx). B633-07: Standard Specification for Electrodeposited Coatings of Zinc on Iron and Steel
- xxi). C177-10: Standard Test Method for Steady-State Heat Flux Measurements and Thermal Transmission Properties by Means of the Guarded-Hot-Plate Apparatus
- xxii). C542-05: Standard Specification for Lock-Strip Gaskets
- xxiii). C1166-06: Standard Test Method for Flame Propagation of Dense and Cellular Elastomeric Gaskets and Accessories
- xxiv). D395-03: Standard Test Methods for Rubber Property-Compression Set
- xxv). D412-06ae2: Standard Test Methods for Vulcanized Rubber and Thermoplastic Elastomers—Tension
- xxvi). D523-08: Standard Test Method for Specular Gloss
- xxvii). D573-04: Standard Test Method for Rubber—Deterioration in an Air Oven

CONFIDENTIAL — DO NOT DISTRIBUTE

- xxviii). D618-08: Standard Practice for Conditioning Plastics for Testing
- xxix). D638-08: Standard Test Method for Tensile Properties of Plastics
- xxx). D624-00: Standard Test Method for Tear Strength of Conventional Vulcanized Rubber and Thermoplastic Elastomers
- xxxi). D746-07: Standard Test Method for Brittleness Temperature of Plastics and Elastomers by Impact
- xxxii). D790: Standard Test Methods for Flexural Properties of Unreinforced and Reinforced Plastics and Electrical Insulating Materials
- xxxiii). D952: Standard Test Method for Bond or Cohesive Strength of Sheet Plastics and Electrical Insulating Materials
- xxxiv). D1149-07: Standard Test Methods for Rubber Deterioration-Cracking in an Ozone Controlled Environment
- xxxv). D2240-05: Standard Test Method for Rubber Property—Durometer Hardness
- xxxvi). D2261: Standard Test Method for Tearing Strength of Fabrics by the Tongue (Single Rip) Procedure
- xxxvii). D3574-95: Seat Cushion Testing Requirements
- xxxviii). D3774-96(2008)e1: Standard Test Methods for Width of Textile Fabric
- xxxix). D3775-08: Standard Test Method for Warp (End) and Filling (Pick) Count of Woven Fabrics
- xl). D3776/D3776M - 09a: Standard Test Methods for Mass Per Unit Area (Weight) of Fabric
- xli). D3884: Standard Test Method for Abrasion Resistance of Textile Fabrics
- xlii). D4956-07: Standard Specification for Retroreflective Sheeting for Traffic Control
- xliii). E94-04: Standard Guide for Radiographic Examination
- xliv). E119-10b: Standard Test Methods for Fire Tests of Building Construction and Materials
- xlv). E162-09: Standard Test Method for Surface Flammability of Materials Using a Radiant Heat Energy Source
- xlvi). E165-02: Standard Test Method for Liquid Penetrant Examination
- xlvii). E168-06: Standard Practices for General Techniques of Infrared Quantitative Analysis

- xlviii). E446-98(2004)e1: Standard Reference Radiographs for Steel Castings Up to 2 in. [51 mm] in Thickness
- xliv). E662-09: Standard Test Method for Specific Optical Density of Smoke Generated by Solid Materials
- l). E709-01: Standard Guide for Magnetic Particle Examination
- li). E709-08: Standard Guide for Magnetic Particle Testing
- lii). E802-95: Standard Reference Radiographs for Gray Iron Castings Up to 4 1/2 in. (114 mm) in Thickness
- liii). F1344-10: Standard Specification for Rubber Floor Tile
- l). AWS (American Welding Society)
 - i). AWS Welding Handbook
 - ii). B2.1/B2.1M: Specification for Welding Procedure and Performance Qualification
 - iii). B2.2/B2.2M: Specification for Brazing Procedure and Performance Qualification
 - iv). B2.3/B2.3M: Specification for Soldering Procedure and Performance Qualification
 - v). C1.1M/C1.1:2000 (R2006): Recommended Practices for Resistance Welding
 - vi). C7.2: Recommended Practices for Laser Beam Welding, Cutting and Drilling
 - vii). C7.4/7.4M: Process Specification and Operator for Laser Beam Welding
 - viii). D1.1/D1.1M: Structural Welding Code – Steel
 - ix). D1.2/D1.2M: Structural Welding Code, Aluminum
 - x). D1.3/D1.3M: Structural Welding Code – Sheet Steel
 - xi). D1.6/D1.6M: Structural Welding Code, Stainless Steel
 - xii). D1.9/D1.9M: Structural Welding Code— Titanium
 - xiii). D17.2/D17.2M: Specification for Resistance Welding in Aerospace Applications
 - xiv). D17.3/D17.3M: Specification for Friction Stir Welding of Aluminum Alloys for Aerospace Applications
- m). Boeing

- i). BSS-7239: Test Method for Toxic Gas Generation by Materials on Combustion
- n). Bombardier
 - i). SMP 800-C: Toxic Gas Generation of "Flex 35 Rev. D" Rubber Compound
- o). British Railways Board Group Standard
 - i). GM/TT0088, Issue 1: Geometric Interfaces Between Railway Wheelsets and Track
- p). CENELEC (European Committee for Electrotechnical Standardization)
 - i). EN 50128: Railway Applications - Communications, Signaling and Processing Systems - Software for Railway Control and Protection Systems
- q). CSA (Canadian Standards Association)
 - i). C22.2, No. 197-M1983: PVC Insulating Tape
- r). EIA (Electronic Industries Alliance)
 - i). 649-A 2004: National Consensus Standard for Configuration Management
- s). European Norms
 - i). DIN EN 13452-1: Railway Applications – Braking - Mass Transit Brake Systems – Part 1: Performance Requirements
 - ii). BS EN 50126: Railway Applications. The Specification and Demonstration of Reliability, Availability, Maintainability and Safety (RAMS)
 - iii). BS EN 50155: Railway applications. Rolling stock. Electronic equipment
- t). GSA (General Services Administration) – Federal Standards
 - i). QQ-B-654A: Brazing Alloys, Silver
 - ii). QQ-P-416F: Plating, Cadmium (Electrodeposited) (S/S by SAE-AMS-QQ-P-416)
 - iii). TT-P-38E: Paint, Aluminum, Ready-mixed
 - iv). TT-P-664D: Primer Coating, Alkyd, Corrosion-inhibiting, Lead and Chromate Free, Con-compliant (S/S by SSPC-PAINT25)
 - v). WW-C-563A: Conduit, Metal, Rigid, Electrical, Thin Wall Steel Type (Electrical Metallic Tubing), Straight Lengths, Elbow, & Bends (S/S by UL797)
 - vi). WW-C-566C: Conduit, Metal, Flexible (S/S by A-A-55810)

- vii). WW-T-799F: Tube, Copper, Seamless, Water (For use with Solder-flared- or Compression-type Fittings) (S/S by ASTM-B88)
- u). IEC (International Electrotechnical Commission)
 - i). 60571: Electronic Equipment used on Rail Vehicles
 - ii). 61373: Railway Application, Rolling Stock Equipment, Shock and Vibration Tests
- v). IEEE (Institute of Electrical and Electronics Engineers)
 - i). 16: Standard for Electrical and Electronic Control Apparatus on Rail Vehicles
 - ii). 1016: Standard for Information Technology-System Design-Software Design Descriptions
 - iii). 1568-2003: Recommended Practice for Electrical Sizing of Nickel-Cadmium Batteries for Rail Passenger Vehicles
 - iv). C37.13: Standard for Low Voltage AC Power Circuit Breakers Used in Enclosures
 - v). C37.14: Standard for Low Voltage DC Power Circuit Breakers Used in Enclosures
 - vi). C37.16: Standard for Preferred Ratings, Related Requirements, and Application Recommendations for Low-Voltage AC (635 V and below) and DC (3200 V and below) Power Circuit Breakers
 - vii). P1477: Passenger Information System for Rail Transit Vehicles
- w). IESNA (Illuminating Engineering Society of North America)
 - i). LM-79-08: Electrical and Photometric Measurements of Solid-State Lighting Products
- x). IFI (Industrial Fasteners Institute)
 - i). Inch Fastener Standards, 7th Edition
 - ii). Metric Fastener Standards, 3rd Edition
- y). IPC (Association Connecting Electronics Industries)
 - i). 2221: Generic Standard on Printed Board Design
- z). ISO (International Organization for Standardization)
 - i). 2631: Mechanical Vibration and Shock – Evaluation of Human Exposure to Whole Body Vibration
 - ii). 9001:2000: Quality Management Systems-Requirements

- iii). 15609-4: Specification and Qualification of Welding Procedures for Metallic Materials – Welding Procedure Specification – Part 4: Laser Beam Welding
- aa). MIL (Military Standards)
 - i). MIL-C-5015: Connectors, Electrical, Circular Threaded, AN Type, General Specification for FSC 5935
 - ii). MIL-C-7438G: Core Material, Aluminum, for Sandwich Construction
 - iii). MIL-DTL-3950G: Detail Specification: General Specification for Switches, Toggle, Environmentally Sealed
 - iv). MIL-DTL-55302F: Detail Specification, Connectors, Printed Circuit Subassembly and Accessories
 - v). MIL-HDBK-132A: Protective Finishes for Metal and Wood Surfaces
 - vi). MIL-HDBK-505: Department of Defense Handbook: Definitions of Item Levels, Item Exchangeability, Models, and Related Terms
 - vii). MIL-I-46058C: Insulating Compound, Electrical (for Coating Printed Circuit Assemblies)
 - viii). MIL-P-13949: Sheet, Printed Wiring Board
 - ix). MIL-P-23469/2B: Pin-Rivet, Grooved, Brazier Head; Straight Shank, Six Locking Grooves, Aluminum Alloy, Corrosion-Resistant and Carbon Steels
 - x). MIL-P-8053C: Plywood, Metal-Faced
 - xi). MIL-S-83502: Socket, Plug-in, Electronic Components, Round to Style (T05)
 - xii). MIL-DTL-83731B: Detail Specification: General Specification for Switches, Toggle, Unsealed and Sealed
 - xiii). MIL-S-83734: Sockets, Plug-in Electronic Components (Right Angle Leads, for 14 and 16 Pin Dual-in-Line Packages)
 - xiv). MIL-PRF-8805D: Performance Specification: General Specifications for Switches and Switch Assemblies, Sensitive, Snap Action (Basic, Limit, Push Button and Toggle Switches)
 - xv). MIL-STD-882E: Standard Practices for System Safety
 - xvi). MIL-STD-883H: Department of Defense Test Method Standard: Microcircuits
 - xvii). MIL-STD-1472: Human Engineering
 - xviii). MIL-T-16366F: Terminals. Electric Lug and Conductor Splices, Crimp-Style
 - xix). MIL-T-55164C: General Specification for Terminal Boards, Molded Barrier, Screw and Stud Types, and Associated Accessories

- bb). NFPA (National Fire Protection Association)
 - i). 10: Standard for Portable Fire Extinguishers
 - ii). 70: National Electric Code
 - iii). 130: Standard for Fixed Guideway Transit and Passenger Rail Systems
- cc). SAE (Society of Automotive Engineers)
 - i). AMS-T-81914/1: Tubing, Plastic, Flexible, Convuluted, Polytetrafluoroethylene, Standard Convolutions
 - ii). AS7928: General Specification for Terminals, Lug: Splices, Conductor: Crimp Style, Copper
 - iii). J995_199907: Mechanical and Material Requirements for Steel Nuts
 - iv). Civilian American and European Surface Anthropometry Resource Project (CAESAR I)
- dd). Amtrak Specifications to be provided by Amtrak:
 - i). AMT-3: Air Brake and Train Handling Rules and Instructions
 - ii). 223: 480VAC Head End Power Jumper & Receptacle Hardware for Passenger Cars & Standby Equipment
 - iii). 315: Public Address/Intercom System
 - iv). 323: High Performance Wire and Cable for Use on Passenger Vehicles
 - v). 352: Flammability, Smoke Emissions and Toxicity for use on Railway Passenger Cars and Locomotive Cabs
 - vi). 353: Vendor Maintenance Manuals
 - vii). 354: Builder Operating & Maintenance Manual Family
 - viii). 429: Specification for Describing Environmental and Operating Conditions
 - ix). 498: 480, 240, 208, 120 VAC and 72VDC Switchboard Panels
 - x). 528: 480, 240, 208, and 120 VAC 72VDC Relay and Contactor Panel
 - xi). 563: Specification for Material and Workmanship for Replacement Truck Springs
 - xii). 665: Seat Cushion Assemblies
 - xiii). 685: Disposable Air Filter

- xiv). 696: Valve and Exterior Equipment Identification Tags & Labels and Operating Instructions
- xv). 697: National On-Board Signage Manual
- xvi). 700: Schematic, Wiring and Piping Diagram Drawings
- xvii). 742-1: Paints and Coatings
- xviii). 759: Replacement of Copper Waste Piping with Non-Metallic Pipe
- xix). 771-1: Specification for General Requirements for Wheels
- xx). 794-1: Specification for Low Location Exit Path Marking Systems for use on Amtrak Passenger Cars
- xxi). 907: Specification for Passenger Car Wheelsets
- xxii). 963: Operational and Environmental Conditions for Rail Rolling Stock
- xxiii). 967: Manufacture and Acceptance of Passenger Seating for Intercity Rail Cars
- xxiv). 973: Specification for Passenger Car Disc Brake Pad Qualification Test
- xxv). 1004: Specification for Thermally Actuated Automatic Drain Valve for Freeze Protection on Passenger Cars
- xxvi). 1118: Specification for Shunt Improvement Device
- ee). Drawings to be provided by Amtrak
 - i). Amtrak
 - (1) A-63-7675-15: Trainline Standard: 27 Point MU System
 - (2) A-63-7676-1: Trainline Standard 27 PT Communication System
 - (3) B-144: Standard Amtrak Coach Key (J.L. Howard Part No. 2555)
 - (4) C-01-1498: 27-Pin Communication Jumper Cable
 - (5) C-63-7422: 27-Pin MU Jumper Cable
 - (6) C-63-7437: 27-Pin MU Receptacles
 - (7) C-96-7591: Standard Trash Container (Amtrak Part No. 24-045-18737)
 - (8) D-00-1359: Speed Sensor and Cable Assembly
 - (9) D-00-7075: Temperature Probe and Connectors
 - (10) D-05-1355: Amtrak Clearance Diagram

- (11) D-12-7191: 480 VAC Jumpers and Housing
- (12) D-63-7439: 27-Pin Communication Receptacle
- (13) D-63-7440: 27-Pin Communication Dummy Receptacle
- (14) D-65-7449: Power Transformers
- (15) D 030-00149: Cab/Baggage Car F-end Pilot Assembly
- (16) E-140-2959: Emergency Equipment Cabinet Arrangement
- (17) S-603: Braking Distance Calculations
- (18) 73195.001.04: No. 8 Welded SGM Turnout
- ii). Metro-North Commuter Railroad Company
 - (1) MSC100001: Clearance Diagram
- iii). Supplemental Documentation
 - (1) Amtrak Intercity Trainset Technical Specification Clarification and Detail – Digital Technology

2.5 Definitions

- a). The definitions and abbreviations defined below are used throughout this technical specification.
- b). Wherever in the Contract Documents terms are used, the definition, intent and meaning shall be interpreted as follows:
 - i). **A**
 - (1) **A-End** (of the car) — Defined as the end of the car opposite from the B-end of all cars except the Cab car.
 - (2) **A/F-End** (of the car) — Defined as the end of the car opposite from the B-end of all car types.
 - (3) **Acceptance** – Status of a submittal by which Amtrak will accept the document for its purpose in the design review process allowing the Contractor to proceed. Amtrak acceptance in no way relieves the Contractor of meeting all requirements of the specification.
 - (4) **Accessible** — To be compliant with the applicable standards for accessibility as defined by the Americans with Disabilities Act of 1990 (ADA) as amended.
 - (5) **Accessible Toilet Room (ATR)** —Toilet room in the passenger rail cars, designed to be compliant with all applicable standards for

accessibility as defined by the Americans with Disabilities Act of 1990 (ADA) as amended.

- (6) **Actuator** — A self-contained brake system component that generates the force to apply the brake shoe or brake pad to the wheel or disc. An actuator typically consists of a cylinder, piston and piston rod.
- (7) **Adhesion, Coefficient of** — During rolling contact, the ratio between longitudinal tangential force at the wheel-rail interface and normal force.
- (8) **Amtrak** — The National Railroad Passenger Corporation, which has its headquarters at 1 Massachusetts Avenue, NW, Washington, DC 20001, and any permitted assignee of Amtrak's rights under the Contract.
- (9) **Analysis** — Written report of the systematic examination of the design, performance and condition of parts, components and systems against Contract and Technical Specification requirements.
- (10) **Approval** — Review and acceptance, in writing, by Amtrak. Amtrak approval in no way relieves the Contractor of meeting all requirements of the specification.
- (11) **Approved Equivalent** — The term "approved equivalent" shall mean an item, which is fully equivalent or superior in terms of form, fit, function, performance and properties, to the specified item.
- (12) **Assembly** — A collection of subassemblies and components typically performing a variety of functions within the context of a larger system.
- (13) **Authorize** — To give authority or power to proceed.
- (14) **Availability** — The percentage of the car fleet usable for revenue service at the beginning of each day's schedule. Also, on per car basis, the percentage of time a car is usable for service:

$$\text{Availability} = \frac{\text{MTBF}}{\text{MTBF} + \text{MTTR}}$$

ii). **B**

- (1) **Baseline Design** — The design of the car or any of its components, apparatus, systems, subsystems, or materials, which has received both drawing approval and first article approval by Amtrak.
- (2) **Baseline Work** — All activities, which shall be performed on the cars in order to comply with the requirements of this Specification.
- (3) **B-End (of the car)** — The end of the car where the hand brake is located on all car types.

- (4) **Bill of Materials** - A list of the components, sub-assemblies, assemblies, and systems required to manufacture the final railcar. The bill of material includes quantities, weights, material, manufacturer's name, and manufacturer's part number.
- (5) **Braking, Blended** — In braking, the simultaneous control of dynamic (rheostatic and/or regenerative) and friction braking, with the effort of each continuously proportioned to achieve the required total braking effort.
- (6) **Braking, Dynamic** — An electric primary braking system on locomotives so equipped, whereby the traction motors act as generators and the current derived thereof is modulated. This includes both rheostatic and regenerative modes.
- (7) **Buff** — Compressive forces acting longitudinally through the carbody's primary structure.
- (8) **Burn-In** — Operating a component, system, or device in a test mode, often in an extreme or cycled temperature environment, for a specified period of time or distance, to confirm reliable operation.
- (9) **Business (Working) Days** – A weekday (Monday to Friday) in the United States that is not an Amtrak holiday. (Also see “**Days**”)

iii). **C**

- (1) **Calibration** — Comparing the performance of a measuring device of unknown accuracy against one of known accuracy.
- (2) **Cant Deficiency** — The condition when a rail vehicle's actual speed through a curve is greater than the speed at which the components of wheel-to-rail force, normal to the plane of the track, would be equalized for the outside and the inside rails.
- (3) **Car/Cars** — The railroad passenger cars to be provided by the Contractor pursuant to this Contract.
- (4) **Carbuilder** — See Contractor.
- (5) **Characteristics** — Any distinct property, or attribute, of the material, or services, that can be described, and measured, to determine conformance, or non-conformance, to Contract requirements.
- (6) **Commissioning** — Activities involved in delivering, adjusting, and testing the cars to demonstrate compliance with Specification requirements and prepare the cars for revenue service.
- (7) **Component** — Usually self-contained, a component is comprised of parts, devices and structure and performs a distinctive function necessary to the operation of a system or subsystem.

- (8) **Concept Drawings** — An initial set of drawings showing the general car layout and arrangement.
- (9) **Conformed Specification** — These Specifications as revised to include and reflect all approved change orders, variances and waivers implemented throughout the duration of the Contract.
- (10) **Contract Deliverable Requirements List (CDRL)** — List of documents and other deliverable items that the Contractor is required to deliver to Amtrak. CDRL is also used to refer to a specific item on the list.
- (11) **Contractor's Drawings** — Items such as general drawings, detail drawings, graphs, diagrams, sketches, calculations, and catalog cuts which are prepared by the Contractor to detail its work.
- (12) **Crash Energy Management, CEM** — Carbody design such that the structures crush in a controlled manner and absorbs energy with the goal to significantly improve crashworthiness.
- (13) **Customer** — Amtrak

iv). **D**

- (1) **Days** — Days shall mean a United States calendar day unless otherwise specified.
- (2) **Delivery, Delivered** — The arrival of the completed vehicle at Amtrak's designated facility, ready for commissioning and acceptance testing.
- (3) **Defect** — Any instance of non-conformance with a specification for material, appearance, finish, function, performance or manufacture.
- (4) **Detrucking** — The complete disconnection and removal as required of all structural, mechanical, pneumatic, and electrical connections between the truck assembly and carbody in order to facilitate the complete jacking of the car to remove the carbody weight from the truck assembly.
- (5) **Device** — Any component, subsystem or system, whether electrical, mechanical, pneumatic or hydraulic.

v). **E**

- (1) **Equal/Equivalent** — Whenever the words "equal", "approved equal", "equivalent" or "approved equivalent" are used in connection with a specified component, material, system characteristic or performance requirement, the Contractor shall prepare and submit for Amtrak approval an analysis that demonstrates that a design, component or system characteristic as proposed by the Contractor has equal or superior appearance, performance interchangeability, availability and

compliance with specification requirements to that of the design, component or system as originally specified. This equivalency shall take the form of a specification variance and shall only be permitted with the specific written approval of Amtrak. The reason for the variance request must be included in the analysis as submitted.

vi). F

- (1) **Fail-Safe** — A characteristic of a system which ensures that no malfunction will create a condition that is not known to be safe.
- (2) **Failure** — A condition in which equipment, components or systems do not function as specified, designed or intended.
- (3) **Failure Mode and Effects Analysis (FMEA)** — A procedure for analysis of potential failure modes within a system for the classification by severity or determination of the failure's effect upon the system.
- (4) **Failure Rate** — The frequency of failure, expressed as failures per hour or failures per mile. Failure rate is the mathematical reciprocal of MTBF or MDBF.
- (5) **Fault Tree Analysis** — A failure analysis in which an undesired state of a system is analyzed using Boolean logic to combine a series of lower-level events. This analysis method is mainly used in the field of safety engineering to quantitatively determine the probability of a safety hazard.
- (6) **Field Modification Instructions (FMI)** — Instructions for applying and installing engineering solutions to resolve fleet-wide defects and/or upgrade installations and/or systems to vehicles that have already been shipped from the factory.
- (7) **First Article** — The first one of any production components of the base item or vehicle that is manufactured using production parts, components, processes and procedures.
- (8) **First Article Inspection (FAI)** — The examination and approval by Amtrak of an initial part, major assembly, subassembly, system, subsystem, apparatus, or material, manufactured or assembled by either the Contractor or Subcontractors. The first article approval establishes the baseline design, configuration and the minimum level of quality for the balance of the production run.
- (9) **Fleet** — All equipment under the contract including all options for additional exercise.
- (10) **Fleet Defect** – Identified when 5% of the quantity of a warranted item fails or where 5% of cars per a fleet type are affected, including those items for which the warranty period expired before Amtrak recognizes the failure.

- (11) **Free Travel** — The vertical lineal distance between the top of rail and a car body reference point as measured under static conditions when comparing an empty car (AW0) and fully loaded car (AW3).

vii). **H**

- (1) **Hazard** — A real or potential condition that can cause injury, death, damage to or loss of equipment or property or damage to environment.
- (2) **Head End Power (HEP)** — Electrical Power (480 VAC, 3-phase, 60 Hz power) produced by a locomotive or power car, or supplied from stationary substation, which is used as the primary electrical power source by the Trainset.

viii). **I**

- (1) **Independent Failure** — A failure which is not the result of another failure, either directly or indirectly.
- (2) **Indicated** — As shown on the Contract Drawings, as described in the Specifications, or as required by other Contract Documents.
- (3) **Inspection** — The careful examination, measurement, and testing of the characteristics and performance of materials, components and systems to ensure conformance with Contract requirements.
- (4) **Inspection Equipment** — Any tool, gauge, fixture, apparatus, or other device used for inspection purposes.
- (5) **Inspector** — The person or firm designated and authorized to perform quality control inspections.
- (6) **Interface** — The points where two or more physical subsystems or systems meet to transfer load, energy or information.

ix). **L**

- (1) **Left-Hand Side** — The side of the car on the left, when standing inside the car at the B-end facing the A-end.
- (2) **Line Replaceable Unit (LRU)** — A modular component designed to be replaced quickly at an operating location to restore the car to an operational ready condition.
- (3) **Lowest Level Replaceable Unit (LLRU)** — The lowest unit (component) of a system or subsystem, which is removable and replaceable from an installed position by standard attachments (e.g., bolts and nuts, quick-disconnects, etc.).

x). **M**

- (1) **Maintainability** — A measure of a car's ability to be properly maintained considering the ease and frequency of maintenance tasks, ability to efficiently use applied labor, and accessibility of equipment to be maintained by Amtrak's maintenance staff. Maintainability is sometimes quantified by the Mean Time To Repair (MTTR).
- (2) **Material** — An all-inclusive term used to denote raw materials, parts, components, assemblies, and equipment used in the finished product.
- (3) **Mean Time Between Failures (MTBF)** — The mean operating time between consecutive independent failures, measured in calendar days as a ratio of the cumulative time to the number of failures under stated conditions.

$$\text{MTBF} = \frac{\text{Total Operating Time (hours)}}{\text{Total Number of Failures}}$$

- (4) **Mean Distance Between Failures (MDBF)** — The mean operating mileage between consecutive independent failures computed as a ratio of the cumulative mileage to the number of failures under stated conditions.

$$\text{MDBF} = \frac{\text{Total Operating Distance (miles)}}{\text{Total Number of Failures}}$$

- (5) **Mean Time Between Component Failures (MTBCF)** — The mean time between individual component failures

$$\text{MTBCF} = \frac{\text{Total Operating Distance (miles)}}{\text{Total Number of Component Failures}}$$

- (6) **Mean Distance Between Service Failures (MDBSF)** — The mean operating mileage between service failures caused by equipment or system failures.

$$\text{MDBSF} = \frac{\text{Total Operating Distance (miles)}}{\text{Total Number of Service Failures}}$$

- (7) **Mean Distance Between Train Delays (MDBTD)** — The mean operating mileage between train delays caused by equipment or system failures.

- (8) **Mean Time To Repair (MTTR)** – The average time required to repair a failed component or device and return it to production status, including time needed for the maintainer to access, remove, replace/repair, close, and test-out the failed component or device. MTTR shall not include logistics time. Expressed mathematically, it is the total corrective maintenance time for failures divided by the total number of corrective maintenance actions for failures during a given period of time.

$$\text{MTTR} = \frac{\text{Total Repair Time (hours)}}{\text{Total Number of Repairs}}$$

- (9) **Mileage, Operating** — The total distance traveled by the Trainset during scheduled and unscheduled movements.
- (10) **Modify** — To change the design, placement, or other aspect(s) of an item to provide for a different form, fit or function or to resolve deficiencies or improve performance.

xi). N

- (1) **New** — An item, OEM or approved equal, which has not previously seen service in whole or in part.
- (2) **No-Motion** — The vehicle speed at or below the lowest speed detectable by the vehicle control systems. Also known as “zero speed”.
- (3) **Normal** — As in, example, "normal operating conditions" or "operating normally" -- A condition in which relevant vehicle equipment is not in a failure mode and the environment is as specified.
- (4) **Notice** — A written announcement from Amtrak.
- (5) **Notice to Proceed (NTP)** — A written notice from Amtrak to the Contractor to officially start work on the Contract.

xii). O

- (1) **Open Items** — Items not resolved on the Trainset or car and documented as incomplete. It is the Contractor responsibility to resolve and close these issues. Open items may be documented at any time during the Contract duration.
- (2) **Original Equipment Manufacturer (OEM)** — The original manufacturer of a hardware subsystem, component or completed vehicle.

xiii). P

- (1) **Permissive**— Potential system response that results in a less safe condition such as proceed versus stop, a higher speed versus a lower speed, acceleration versus deceleration, brakes released versus brakes applied, or no actuation of alarm versus actuation of alarm.
- (2) **Pilot Car(s)** — the first car (of each type) to be fully assembled at the Contractor's final assembly facility.
- (3) **Procurement (Work)** — The furnishing of all equipment, items, materials, parts, systems, data, design, services, incidentals, labor and management and performance of the contractual requirements defined

in the Contract Documents, including changes thereto, in order to produce and deliver the specified Trainsets, cars, spare parts, hardware and software goods, and services.

- (4) **Proof** (used as a suffix) — Apparatus as designated as splash-proof, dust-proof, etc., when so constructed, protected, or treated that its successful operation is not interfered with when subjected to the specified material or condition.
- (5) **Push-Pull Operations** — A method of controlling the actions of the propulsion, braking and other systems of a train from a control cab, located in either the locomotive or the cab car, for bi-directional operation.

xiv). **R**

- (1) **Railroad** — Amtrak, or the owner(s) of the operating railroad over which Amtrak's trains operate, and/or the property and/or improvements used in connection with such operating railroads, as defined by 49 CFR Part 238.
- (2) **Rapid Prototype Car(s)** — the first car (of each type) to be prototyped for form and fit issues that can be identified prior to production at the Contractor's final assembly facility.
- (3) **Redundancy** — The existence of more than one means for accomplishing a given function. The ability to accomplish a given function by two or more independent means.
- (4) **Reliability** — The ability of a system to perform the required function under stated operating conditions for a stated period of time. This is defined as the failure rate of an item expressed as a percentage or in time of operating hours. The desired result is to have high reliability (100%) with a low failure rate (0%).
- (5) **Remanufacture** — To rebuild and recertify to OEM standards for functionality and appearance. Parts that cannot be remanufactured shall be renewed.
- (6) **Renew** — To replace with a new equivalent component (regardless of condition of part being renewed).
- (7) **Repair** — Correct specific damage to return to original condition or functionality.
- (8) **Restrictive** — Potential system response that results in a safer condition such as stop versus proceed, a lower speed versus a higher speed, deceleration versus acceleration, brakes applied versus brakes released or actuation of alarm versus no actuation of alarm.
- (9) **Revenue Service** — When a rail car or trainset is available to the general public and there is a reasonable expectation of carrying

CONFIDENTIAL — DO NOT DISTRIBUTE

passengers that either directly pay fares, are subsidized by public policy, or provide payment through some contractual arrangement. Vehicles operated in fare free service are considered in Revenue Service.

- (10) **Right-Hand Side** — The side of the car on the right, when standing inside the car at the B-end facing the A-end.

xv). **S**

- (1) **Safe** — Secure from potential harm, injury, danger or risk; free from danger or risk.
- (2) **Safety** — The condition in which persons and equipment are free from threat, danger, harm, or loss arising from improper design, manufacture, assembly or function, or a failure of the car or any of its components or systems.
- (3) **Safety Critical** — A system, or any portion thereof, means the correct performance of which is essential to safety of personnel or Vehicle, or both; or the incorrect performance of which could cause a hazardous condition, or allow a hazardous condition which was intended to be prevented by the function or system to exist.
- (4) **Service** — (as in service use, service braking.) The operation of the cars under normal conditions.
- (5) **Service Failure** — A car-related failure causing a train in service to be:
- (a) More than 60 minutes late at its destination terminal;
 - (b) Canceled either at its originating point or enroute; or
 - (c) Relocation of 20% or more of passengers from a car
 - (d) Loss of 50% of food service in any food service car
 - (e) Loss of 10% of any sleeper accommodation type in a car which shall include the failure of the water and waste system in any accommodation.
 - (f) The loss of any elevator or onboard mobility device lift
 - (g) Loss of water and waste system in a car during Revenue Service
 - (h) Loss of doors that inversely affects boarding and alighting, passenger comfort and/or any passenger accommodation
 - (i) For the Coach, Food Service and Lounge Cars, any passenger impact items, including but not limited to, HVAC, lighting, and windows that affect ten percent (10%) or more of the Trainset

revenue seating capacity or adversely affect the viewing pleasure of the passenger.

- (6) **Services** — Work and incidental material specified in a Contract such as inspection, nondestructive examination, calibration, testing, welding, analysis, etc.
- (7) **Shipment** — The physical movement of the Trainsets or cars from the Contractor's production facility to the Contractor's designated acceptance facility or other designated destination.
- (8) **Shop Drawings** — Drawings or sketches prepared by the Contractor for use in its manufacturing facility, assembly facility, or shop, to fabricate, assemble, and/or install parts of the vehicles, whether manufactured by it from raw materials or purchased from others in a ready-to-use condition.
- (9) **Slide, Wheel** — During braking, the condition when the rotational speed of the wheel is slower than that of the actual pure rolling contact between tread and rail.
- (10) **Slip, Wheel** — During acceleration, the condition existing when the rotational speed of the wheel is faster than that of pure rolling contact between tread and rail.
- (11) **Special Tools** — All specialized tools, gauges, meters, diagnostic Vehicle (including laptop computer software), etc. that will be necessary to operate, maintain, overhaul, inspect, test, troubleshoot and repair all configurations of the throughout its design life. Special tools do not include those tools that are commercially available "off the shelf".
- (12) **Specified or As specified** — As stated in this document or other referenced documents.
- (13) **Speed, Design** — The specified maximum possible operating speed of the Trainset or car. The Trainset and all components shall be suitable for safe operation at all speeds up to and including this speed.
- (14) **Standards and Specifications** — When industry, government, association, or society standards or specifications are referred to, the applicable issue at the time of Notice to Proceed (NTP) signing shall be used.
- (15) **Step, Signal** — A signal having a constant value prior to the step and a different constant value immediately thereafter.
- (16) **Stop, Emergency** — The stopping of a vehicle or train by an emergency brake application.
- (17) **Subassembly** — A collection of components used to perform a distinct function, usually in conjunction with other subassemblies and

CONFIDENTIAL — DO NOT DISTRIBUTE

components, as part of a larger system. Subassemblies are usually replaceable as units, such as circuit boards, bearings and valves.

- (18) **Subsystem** — A defined portion of a system.
- (19) **Superelevation** — The vertical difference between the top surface of the outside and inside rails of a curve.
- (20) **System** — A combination of hardware, people, and or software systems, in any combination which are integrated to perform a specific operational function.

xvi). **T**

- (1) **Tamperproof** — Fasteners are designated as tamperproof when they are selected so that they can not be easily loosened with common tools such as screwdrivers or pliers.
- (2) **Tare** — A term in weights and measurements which refers to the weight of an empty container. The tare weight can be subtracted when a filled container is weighed to determine the weight of the contents alone.
- (3) **Test, Installation and Removal** — Tests are maintainability related tests which are used to ensure equipment, as designed, can be easily removed and replaced.
- (4) **Test, Proof of Design** — Proof-of-Design tests are engineering tests which are used to ensure equipment, as designed, meets the functional and performance requirements of the vehicle specifications.
- (5) **Test Plan** — A document that defines the plan and schedule for conducting all the tests required on the vehicle.
- (6) **Test Procedure** — A step-by-step procedure that identifies the equipment, exact sequence of events and criteria used to ensure that components and systems function properly.
- (7) **Test, Production** — A series of tests applied to each component or vehicle to ensure all systems and components perform according to design and specification.
- (8) **Tight** (used as a suffix) — Apparatus is designed as watertight, dust-tight, etc., when so constructed that the design will exclude the specified material from affecting the functioning condition or performance of the component or system.
- (9) **Time, Warm-up** — The elapsed time from application of power to an operable device until it is capable of performing its intended function.
- (10) **Train** — Any number of cars coupled to a locomotive or a source of self-propulsion, and moving as one.

- (11) **Train Delay** — A train delay is defined as a Trainset-related failure that causes a train in service to be: more than 15 minutes late at its destination terminal; canceled either at its originating point or en-route; or reduced in size or revenue capacity due to requiring a failed car to be removed from the train.
- (12) **Trainset** — a collection of passenger cars which are semi-permanently coupled to create a fixed consist to be used for a particular train application; a trainset car is that portion of the trainset which is located between coupling arrangements.
- (13) **Tram** — A condition of ideal truck geometry in which the axles are perfectly parallel and the wheels longitudinally in perfect alignment. The centers of the journal bearings represent the corners of a perfect rectangle. Tram is checked by measuring the diagonal and longitudinal distances between reference points on the axle bearing housing.

xvii). U

- (1) **Unsafe** — A safety risk is not acceptable according to the risk criteria defined in the System Safety Program Plan (SSPP).
- (2) **U.S. Department of Transportation (USDOT)** — Means the Secretary of the USDOT and other persons who may at the time be acting in the capacity of the Secretary, or authorized representative or any person otherwise authorized to perform the functions to be performed hereunder, including representatives of the Federal Transit Administration (FTA) and Federal Railroad Administration (FRA).

xviii). V

- (1) **Vehicle History Book** — A document specific to an individual rail vehicle containing records of technical and parts data pertinent to that individual vehicle.
- (2) **Verification** — Examination and testing by the QA Representative to confirm decisions made by those performing the work concerning conformance of material to Contract requirements.
- (3) **Vehicle** — Same as car or locomotive.

xix). W

- (1) **Warp, Track** — The difference in crosslevel of any two points within the specific distance along the track. The warp parameter in the track geometry is used to specify the maximum in the crosslevel difference of the track in any segment (tangents, curves and spirals).
- (2) **Weatherproof** — Able to withstand exposure to all weather and environmental conditions without damage or loss of function.

- (3) **Weights, Assigned** — The loaded car categories assigned by Amtrak as the basis for structural repair design and for subsystem and vehicle testing as indicated. Four weight categories are assigned:
- (a) AWO: Actual weight of empty car, ready for revenue service, but with neither crew nor passengers aboard. Includes full fresh water supply, empty waste system and full complement of provisions in the Food service car.
 - (b) AW1: Car at seated load and no standees.
 - (i) Seated Load is defined as all the passenger seats occupied plus one crew member per car.
 - (c) AW2: Car at normal full load.
 - (i) Normal Full Load is defined as seated load plus one standee per 3 ft² of clear floor space.
 - (d) AW3: Car at crush load.
 - (i) Crush Load is defined as seated load plus one standee per 1.5 ft² of clear floor space. Each passenger or standee is assumed to weigh an average of 180 pounds.
- (4) **Weight, Dry** — The measured axle weight of an empty passenger rail car (measured dry). Fully assembled but with no water or provisions.

xx). **Z**

- (1) **Zero Speed** — See "No motion".

c). Clarifications

- i). Whenever in the specifications or on the plans the words "**required,**" "**determined,**" "**directed,**" "**specified,**" "**authorized,**" "**ordered,**" "**given,**" "**designated,**" "**indicated,**" "**considered necessary,**" "**deemed necessary,**" "**permitted,**" "**reserved,**" "**suspended,**" "**established,**" "**approval,**" "**approved,**" "**disapproved,**" "**acceptable,**" "**unacceptable,**" "**suitable,**" "**accepted,**" "**satisfactory,**" "**condemned,**" or words of like import are used, it shall be understood as if such words were followed by the words in writing, "**by Customer,**" "**to Customer,**" "**Amtrak**" unless otherwise specifically stated.
- ii). Wherever the words "**provided,**" "**supplied,**" or "**installed**" are used in the specifications in reference to work to be performed by the Contractor, it shall be understood to mean "**furnished and delivered completed and ready for revenue service.**"

2.6 Acronyms and Abbreviations

- a). The following is a list of acronyms and abbreviations in this specification. The list

is not intended to be all-inclusive.

i). **A**

- (1) **AALA** American Association of Laboratory Accreditation
- (2) **AAR** Association of American Railroads
- (3) **AC** Alternating Current
- (4) **ADA** Americans with Disabilities Act of 1990 as amended
- (5) **AED** Automated External Defibrillator
- (6) **AEI** Automatic Equipment Identification
- (7) **AESS** Automatic Engine Stop Start
- (8) **amp** ampere
- (9) **ANSI** American National Standard Institute
- (10) **APTA** American Public Transportation Association
- (11) **ASHRAE** American Society of Heating, Refrigeration and Air Conditioning Engineers
- (12) **ASME** American Society of Mechanical Engineers
- (13) **ASSE** American Society of Sanitary Engineers
- (14) **ASTM** American Society for Testing and Materials
- (15) **ATC** Automatic Train Control
- (16) **ATOR** Above Top of Rail
- (17) **ATR** Accessible Toilet Room
- (18) **ATS** Automatic Train Stop
- (19) **AWO** Empty vehicle operating weight, Ready-to-Run
(Assigned Weight "0" load)
- (20) **AW1** Car at seated load and no standees.

- (21) **AW2** Car at normal full load.
- (22) **AW3** Car at crush load.
- (23) **AWS** American Welding Society
- ii). **B**
 - (1) **BC** Battery Charger
 - (2) **B.C.P.** Brake Cylinder Pressure
 - (3) **BP** Brake Pipe
 - (4) **Btu** British Thermal Unit
- iii). **C**
 - (1) **C** Celsius
 - (2) **CAD** Computer-Aided Design
 - (3) **CCJPA** Capitol Corridor Joint Powers Authority
 - (4) **CCTV** Close Circuit TV
 - (5) **CCU** Communication Control Unit
 - (6) **CDU** Central Diagnostics Unit
 - (7) **CDRL** Contract Deliverable Requirements List
 - (8) **CDT** Central Diagnostics Terminal
 - (9) **CEM** Crash Energy Management
 - (10) **CFC** Chlorinated Fluorocarbons
 - (11) **cfm** Cubic Feet per Minute
 - (12) **CFR** Code of Federal Regulations
 - (13) **CO** Central Office
 - (14) **COMM** Communication
 - (15) **COTS** Clean, Oil, Test and Stencil
 - (16) **CPM** Critical Path Method
- iv). **D**
 - (1) **DB** Dry Bulb

- (2) **dB** Decibel
- (3) **dB/sec** Decibels per second
- (4) **dba** Decibels (Acoustic)
- (5) **dba/sec** Decibels (Acoustic) per second
- (6) **DC** Direct Current
- (7) **DCS** Data Communication System
- (8) **DR** Design Review
- (9) **DTE** Diagnostic Test Equipment
- (10) **DTN** Data Trainline Network
- (11) **DVD** Digital Versatile Disc
- (12) **DVD-RW** Digital Versatile Disc – Rewriteable

v). **E**

- (1) **EAB** Electronic Air Brake
- (2) **ECP** Electronically Controlled Pneumatic
- (3) **ECR** Engineering Change Request
- (4) **EEPROM** Electrically Erasable Programmable Read Only Memory
- (5) **ECR** Engineering Change Request
- (6) **e.g.** *exempli gratia* (for example)
- (7) **EMC** Electromagnetic Compatibility
- (8) **EMD** Electro Motive Diesel (a locomotive and component manufacturer)
- (9) **EMI** Electromagnetic Interference
- (10) **EMIS** Equipment Maintenance Information
- (11) **EPA** U.S. Environmental Protection Agency
Equipment Maintenance Information
- (12) **EPROM** Erasable Programmable Read Only Memory

- (13) **ER** equalizing reservoir
- (14) **etc.** et cetera (and so forth)
- (15) **ETMS** Electronic Train Management System

vi). F

- (1) **F** Front (end of locomotive or cab car designator as defined by 49 CFR Part 229.11)
- (2) **F** Fahrenheit
- (3) **FAI** First Article Inspection
- (4) **Fc** foot-candle
- (5) **FCC** Federal Communication Commission
- (6) **FDA** U.S. Food & Drug Administration
- (7) **FDR** Final Design Review
- (8) **FEA** Finite Element Analysis
- (9) **FEM** Finite Element Model
- (10) **FMEA** Failure Mode and Effects Analysis
- (11) **FMECA** Failure Modes and Effects Criticality Analysis
- (12) **FMI** Field Modification Instruction
- (13) **Fpm** feet per minute
- (14) **FRA** Federal Railroad Administration (U.S. Department of Transportation)
- (15) **FRP** Fiberglass Reinforced Plastic
- (16) **Ft** Foot
- (17) **ft²** square foot
- (18) **ft³** cubic foot
- (19) **FTA** Federal Transit Administration (U.S. Department of Transportation)

vii). G

- (1) **g** Acceleration due to gravity
- (2) **gal** Gallon
- (3) **GB** Gigabyte
- (4) **GFCI** Ground Fault Circuit Interrupter
- (5) **GHz** Gigahertz
- (6) **gpm** gallons per minute
- (7) **GPS** Global Positioning System

viii). H

- (1) **HAZ** Heat-Affected Zones
- (2) **HBPS** Holding Brake Pressure
- (3) **HDL** Hydrodynamic Labyrinth
- (4) **HDMI** High Definition Multimedia Interface
- (5) **HEP** Head End Power
- (6) **Hg** Mercury (pressure or vacuum – measured in inches)
- (7) **HPPL** High Pressure Photoluminescent
- (8) **hr** Hour
- (9) **Hz** Hertz
- (10) **HVAC** Heating, Ventilation, and Air Conditioning

ix). I

- (1) **i.e.** id est (that is)
- (2) **IC** Intercommunication
- (3) **IDR** Intermediate Design Review
- (4) **IEC** International Electrotechnical Commission
- (5) **IEEE** Institute of Electrical and Electronic Engineers
- (6) **IGBT** Insulated Gate Bipolar Transistor

	(7)	in.	Inch
	(8)	in²	square inch
	(9)	IPC	Illustrated Parts Manual
	(10)	IPS	Iron Pipe Size
	(11)	ISO	International Organization for Standardization
	(12)	ISP	Internet Service Provider
	(13)	IVDN	Inter-Vehicle Data Network
	(14)	IWS	Instrumented Wheelset
x).		J	
	(1)	JEDEC	Joint Electronics Device Engineering Council
xi).		K	
	(1)	K	Kelvin
	(2)	kg	Kilogram
	(3)	kHz	Kilohertz
	(4)	km	Kilometer
	(5)	ksi	1000 pounds per square inch (psi)
	(6)	kW	kilowatt
xii).		L	
	(1)	LAHT	Low Alloy High Tensile
	(2)	lb	Pound
	(3)	lbf	pounds of force
	(4)	lbs/ft²	pounds per square foot
	(5)	LCC	Life Cycle Cost Analysis
	(6)	LCD	Liquid Crystal Display
	(7)	LDTS	Local Diagnostic and Test System
	(8)	LED	Light Emitting Diode

- (9) **LLEPM** Low Location Exit Pathway Markings
- (10) **LLRU** Lowest Level Replaceable Unit
- (11) **lm** Lumen
- (12) **Log** Inspection and Test Log
- (13) **LRU** Line Replaceable Unit
- (14) **LSA** Lead Service Attendant
- (15) **lx** Lux
- (16) **LVPS** Low Voltage Power Supply

xiii). M

- (1) **m** Meter
- (2) **mA** Milliampere
- (3) **MAP** Maintenance Analysis Program
- (4) **MB** Megabyte
- (5) **Mbps** Megabits Per Second
- (6) **MCAT** Minimally Compliant Analytical Track
- (7) **MCSCM** Mechanical Committee of Standard Coupler Manufacturers
- (8) **MDBCF** Mean Distance Between Component Failures
- (9) **MDBF** Mean Distance Between Failures
- (10) **MDBSF** Mean Distance Between Service Failures
- (11) **MDBTD** Mean Distance Between Train Delays
- (12) **mg/sq.in.** milligrams per square inch
- (13) **MHz** Megahertz
- (14) **MIG** Metal Inert Gas
- (15) **MIL** Military Specification
- (16) **min** Minute, minutes
- (17) **mm** Millimeter

- (18) **MP3** MPEG Audio Layer 3
- (19) **MPa** Megapascal
- (20) **mph** miles per hour
- (21) **mphps** miles per hour per second
- (22) **mphpsps** miles per hour per second per second
- (23) **MR** Main Reservoir
- (24) **MSDS** Material Safety Data Sheet
- (25) **msec** Milliseconds
- (26) **MTBF** Mean Time Between Failures
- (27) **MTTR** Mean Time To Repair
- (28) **MU** Multiple Unit
- (29) **mV** Millivolt

xiv). **N**

- (1) **N/A** Not Applicable
- (2) **NAS** Network Attached Storage
- (3) **NBS** National Bureau of Standards
- (4) **NC** Normally Closed
- (5) **NDE** Non-Destructive Examination
- (6) **NEC** Northeast Corridor
- (7) **NEMA** National Electrical Manufacturers Association
- (8) **NFL** No Field Lubrication
- (9) **NFPA** National Fire Protection Association
- (10) **NIC** Network Interface Card
- (11) **Ni-CAD** nickel-cadmium
- (12) **NO** Normally Open
- (13) **NPT** National Pipe Thread

- (14) **NRPC** National Railroad Passenger Corporation (Amtrak)
- (15) **NPRD** Non-Electronic Parts Reliability Database
- (16) **NSF** National Sanitation Foundation
- (17) **NTP** Notice-to-Proceed
- (18) **NTSB** National Transportation Safety Board

xv). **O**

- (1) **OCU** Operator Control Unit
- (2) **ODBC** Open Data Base Connectivity
- (3) **ODK** Operator Display Keypad
- (4) **OEM** Original Equipment Manufacturer
- (5) **OFE** Oxygen Free Electronic
- (6) **OSHA** Occupational Safety and Health Administration
- (7) **OTIS** Onboard Train Information System
- (8) **oz** ounce

xvi). **P**

- (1) **p/n** part number
- (2) **PA** Public Address
- (3) **PA/IC** Public Address/Intercom
- (4) **PC** Personal Computer
- (5) **PCB** Printed Circuit Board
- (6) **PCMCIA** Personal Computer Memory Card International Association
- (7) **PCS** Pneumatic Control Switch
- (8) **PDF** Portable Document Format
- (9) **PDR** Preliminary Design Review
- (10) **PHS** Public Health Service

- (11) **PIDS** Passenger Information Display System
- (12) **PIS** Passenger Information System
- (13) **PISCU** Passenger Information System Control Unit
- (14) **PKO** Power Knock/Out
- (15) **PM** Preventative Maintenance
- (16) **PMP** Project Management Plan
- (17) **POS** Point-of-Sale
- (18) **ppm** parts per million
- (19) **pphm** parts per hundred million
- (20) **PRIIA** Passenger Rail Investment and Improvement Act
- (21) **PROM** Programmable Read-Only Memory
- (22) **psi** pounds per square inch
- (23) **psig** pounds per square inch (gauge)
- (24) **PTC** Positive Train Control
- (25) **PTE** Portable Test Equipment
- (26) **PTT** Push to Talk
- (27) **PTU** Portable Test Unit
- (28) **PVC** Polyvinyl Chloride
- (29) **PWM** Pulse Width Modulation

xvii). Q

- (1) **QA** Quality Assurance
- (2) **QC** Quality Control

xviii).R

- (1) **RAID** Redundant Array of Independent Disks
- (2) **RAM** Random Access Memory
- (3) **RAM** Reliability Availability and Maintainability

- (4) **RDT** Reliability Demonstration Test
- (5) **RFI** Radio Frequency Interference
- (6) **RFP** Request for Proposal
- (7) **RGB** red green blue
- (8) **RH** Relative Humidity
- (9) **rms** root mean square

xix). S

- (1) **S&I** Service and Inspection
- (2) **SAE** Society of Automotive Engineers
- (3) **SCFM** Standard Cubic Feet per Minute
- (4) **sec** Second
- (5) **SIV** Secondary Impact Velocity
- (6) **SNR** Signal-to-Noise Ratio
- (7) **SQL** Structured Query Language
- (8) **SSP** System Safety Plan
- (9) **SSS** Sign System Server

xx). T

- (1) **t** Thickness
- (2) **T/L** Trainline
- (3) **T/R** Transmitter/Receiver
- (4) **TB** Terabyte
- (5) **TBD** To Be Determined
- (6) **TCD** Train Communications Data
- (7) **TFT** Thin Film Transistor
- (8) **TIG** Tungsten Inert Gas
- (9) **TLC** Trainline Complete
- (10) **TMS** Train Monitoring System

- (11) **TOR** Top of Rail
- (12) **TSA** US Transportation Security
- (13) **TSSSA** Technical Support, Spares and Supply Agreement
- (14) **TTCI** Transportation Test Center

xxi). U

- (1) **U.S.** United States
- (2) **UL** Underwriter's Laboratories, Inc.
- (3) **ULSD** Ultra Low Sulfur Diesel
- (4) **UMLER** Universal Machine Language Equipment Register
- (5) **USB** Universal Serial Bus
- (6) **USDOT** United States Department of Transportation
- (7) **USPHS** U.S. Public Health Service of the U.S. Department of Health and Human Services
- (8) **USS** United States Steel Corporation
- (9) **UV** Ultraviolet

xxii). V

- (1) **V** Volt
- (2) **VAC** Volt Alternating Current
- (3) **VDC** Volts Direct Current
- (4) **VDSL2** Very High Speed Digital Subscriber Line 2
- (5) **VTI** Vehicle Track Interaction

xxiii). W

- (1) **W** Watt
- (2) **W/ft²** watts per square foot

- (3) **WB** Wet Bulb
 - (4) **WCRS** Waste Collection and Retention
 - (5) **WiFi** Wireless Fidelity (Wireless Local Area Network protocol, IEEE 802.11b, 802.11g and 802.11n)
 - (6) **WLAN** Wireless Local Area Network
 - (7) **WMS** Work Management System
 - (8) **WPS** Welding Procedure Specifications
- xxiv). Y**
- (1) **yr** Year
- xxv). Z** :
- (1) **Z** Impedance

* End of Chapter 2 *

Amtrak Long Distance Bi-Level Fleet Replacement

Technical Specification

3. Project Management & Reviews

Revision 1

Table of Contents

3.1	Overview.....	3-1
3.2	Project Management Plan (PMP).....	3-1
3.3	System Integration Plan (SIP) and Interface Control Document (ICD)	3-2
3.4	Coordination with TSSSA Contract.....	3-3
3.5	Galley Design Specialist.....	3-4
3.6	Interface with Subcontractors, Designers, and Suppliers	3-4
3.7	Documentation Control	3-5
3.8	Initial Meetings.....	3-5
3.9	Project Review Meetings (PRM).....	3-6
3.10	Master Project Schedule (MPS).....	3-7
3.11	Project Progress Schedule Updates	3-9
3.12	Recovery Schedule.....	3-11
3.13	Design Review Overview	3-11
3.14	Amtrak Involvement	3-21
3.15	Design Review Stages.....	3-22
3.16	Industrial Product Design Review Stages	3-32
3.17	Mockup Development and Review.....	3-38
3.18	Virtual Mock-Up	3-49
3.19	Renderings	3-50
3.20	Color Material and Finish (CMF).....	3-53
3.21	Requirements for Drawings, Documents and Data	3-54
3.22	Rapid Prototype Cars.....	3-59
3.23	CDRLs.....	3-60

Table of Figures

Figure 3-1:	Design Review Submittal Statuses	3-20
Figure 3-2:	Design Review Summary Matrix	3-31

3.1 Overview

- a). This chapter includes Project Management requirements for schedule, drawings, document control, and other program support functions.
- b). All correspondence, drawings, data, manuals or other written communications pertaining to this Contract shall be in the English language.
- c). All dimensions shall be shown in standard imperial units of inches and decimals, with a metric equivalent shown in parentheses adjacent to the imperial dimension. If a component or subassembly uses metric units as the primary system of measurement, then imperial equivalents shall be provided in parentheses.

3.2 Project Management Plan (PMP)

- a). The Contractor is required to develop a Project Management Plan (PMP) which shall define how the project is to be executed, monitored, and controlled.
- b). The PMP shall be submitted to Amtrak for review and approval no later than 30 days after NTP. **[CDRL 3-01]**
- c). The PMP shall include as a minimum the following elements:
 - i). Project Description
 - ii). Organizational Chart including all staff supporting the program
 - (1) Key positions including Senior to Mid-level Management shall identify the individual and his/her contact information.
 - (2) First Level Management and resource staff positions shall be shown to clarify staffing levels, but do not need to include the individual's information. However, the planned date of filling each of these positions shall be identified.
 - iii). Roles, responsibilities and authority of all key and decision-making personnel
 - iv). Contact information for principal subcontractors
 - v). Document control processes
 - vi). Communication processes
 - vii). Risk Management processes
 - viii). Material Procurement Management Plan that includes draft list of major sub-suppliers
 - ix). Project Schedule Management Plan, the contractor will provide a narrative describing how the schedule will be managed throughout the period of

performance of the Contract. Specifically, the policies, procedures, and documentation for planning, developing, managing, executing, and controlling the project schedule.

- x). Reference to document names and numbers for processes such as:
 - (1) Configuration Management
 - (2) Change Management
 - (3) Field Service Support
 - (4) Warranty Support
- d). For the duration of the Contract, the Contractor shall revise and resubmit the PMP to properly reflect the processes and procedures implemented in the performance of the contracted work.
 - i). The Contractor shall revise the PMP when it varies significantly from implemented practice but at a minimum every twelve months.
 - ii). Should Amtrak become aware of significant discrepancies between the PMP and the Contractor's practice, it would request a revision and resubmittal.
- e). The Contractor's Project Manager shall be the prime contact person to Amtrak.
 - i). All Subcontractor formal correspondence shall be through the Contractor's Project Manager.
- f). Any proposed changes to key personnel named in the Project Organizational Chart shall be formally submitted in advance of implementation for Amtrak review and approval.

3.3 System Integration Plan (SIP) and Interface Control Document (ICD)

- a). The Contractor's Systems Integration Plan (SIP) shall be based on the Preliminary Systems Integration Plan submitted as part of the Contractor's proposal.
- b). The SIP shall include the Contractor's processes and procedures for validating and verifying that system integration is embedded in the design and manufacturing processes of the cars.
- c). The SIP shall identify a System Integration Lead who shall be responsible for all mechanical, electrical and digital integration between systems and sub-systems.
 - i). The System Integration Lead shall be maintained on the project throughout the design review process until acceptance of the pilot trainset.
- d). The SIP shall detail the system integration between all systems, cars, locomotives and with Amtrak's infrastructure.

- e). The SIP shall explain how integration with suppliers' systems will be managed.
- f). The SIP shall be submitted to Amtrak for review and approval no later than 30 days prior to the first Preliminary Design Review meeting. **[CDRL 3-02]**
- g). The SIP shall detail the implementation of a single Interface Control Document (ICD) which will cover each type and class of car.
- h). Any interfaces and/or protocols between two (2) or more systems or components shall be tracked through the ICD.
- i). Any interface mitigation resolution shall be documented in the ICD.
- j). The ICD shall include, as a minimum:
 - i). System
 - ii). Interface type
 - iii). Interface from
 - iv). Interface to
 - v). Description/Requirement
 - vi). Method of Validation
 - vii). Other information as required to ensure proper integration
- k). The ICD shall be submitted to Amtrak for review and approval, no later than 30 days prior to the first Preliminary Design Review meeting and then quarterly thereafter. **[CDRL 3-03]**
- l). The ICD shall be maintained throughout the production process and shall be revised, as necessary, to reflect engineering changes and field modifications.
- m). Prior to the ICD submittal to Amtrak, the Contractor's System Integrator shall review and approve all design documents that describe interfaces between and among components, systems and cars.

3.4 Coordination with TSSSA Contract

- a). The Management Teams for the Trainset and the TSSSA contracts shall both be overseen by a single Fleet Director.
- b). The Fleet Director shall be maintained through the delivery of the final piece of equipment on the base Trainset contract.
- c). The Fleet Director shall attend, at a minimum, all Trainset monthly status meetings.
- d). The Trainset and TSSSA Teams shall present to Amtrak as a single entity with

CONFIDENTIAL — DO NOT DISTRIBUTE

conflicting priorities between the groups never impacting the progress of the program as a whole.

- e). The Fleet Director shall ensure that both teams are working cohesively optimizing system reliability and transitioning to TSSSA technical services.
 - i). The Fleet Director shall ensure TSSSA Technical staff are in attendance at Design Review meetings to ensure long-term maintenance concerns are considered.
 - ii). The Fleet Director shall ensure that the TSSSA technical services personnel have extensive experience gained through the production of the Trainset Contract.

3.5 Galley Design Specialist

- a). Throughout Design Review and Pilot Trainset production, the Contractor shall maintain a galley design specialist to support the development, simulation and optimization of the food service areas of the trainset.
- b). The galley design specialist may be a direct employee of the Contractor or a consultant but shall be a recognized expert in the field of restaurant design and on-board food service in the transportation industry.
- c). The galley design specialist shall participate in design reviews, mock-up evaluation, workshops and qualification testing of on-board food service areas.
- d). The galley design specialist shall be considered a key member of the Contractor's design team.

3.6 Interface with Subcontractors, Designers, and Suppliers

- a). The Contractor shall inform all designers and subcontractors of all specified requirements and ensure that appropriate engineering management tools are utilized to coordinate and provide communication among the designers of interrelated systems.
- b). Subcontractors shall be made aware of additional requirements listed throughout other chapters of this technical specification.
- c). Subject to Amtrak review and approval, the Contractor may request major Subcontractors be granted access to the Project's collaborative website.
- d). All applications of material or equipment by the Contractor shall be with the full concurrence of the Subcontractor that the application is suitable and within the recommended limits of operation of the material or equipment.
- e). The Contractor shall have all relevant designers and Subcontractors available when required for:
 - i). Meetings

- ii). Design Reviews
 - iii). Resolution of Production or Manufacturing problems
 - iv). Testing
 - v). Resolution of design, integration, or quality deficiencies
 - vi). Resolution of Systems Reliability problems, and
 - vii). All other similar situations.
- f). During all phases of this project, Amtrak shall have access to all designers and Subcontractors through coordination with the Contractor's Project Manager.
- g). The Contractor shall coordinate all the project administration, scheduling, design, validation, commissioning and warranty activities with Amtrak's project management team.
- h). At Amtrak's sole discretion, suppliers' technical staff must attend all relevant design reviews throughout the process to ease the communication flow between Amtrak, the Contractor and Suppliers.

3.7 Documentation Control

- a). Amtrak shall use its Document Management System (DMS) as the documentation control system for the TSSSA program.
- b). While the Contractor may opt to use its own document control system internally, it shall use the DMS when submitting documents and contract letters to Amtrak and shall adhere to the processes inherent to that system.
- c). During the course of the TSSSA program, Amtrak will have the right to transition to a different documentation management program.

3.8 Initial Meetings

- a). Within 15 calendar days after NTP, a series of Kick-off Meetings shall be conducted for the Contractor to accomplish the following:
 - i). Review Contractor's Project mobilization activities
 - ii). Introduce the Key personnel of the team
 - iii). Establish communication protocols
 - iv). Establish the document coding schemes
 - v). Establish formats for Master Project Schedule and Monthly Reports
 - vi). Establish the format for an Open Items Tracking Matrix

- vii). Establish project control methodology
 - viii). Confirm plans for initial activities prior to start of formal progress reporting, including all CDRLs due in the next 90 calendar days.
 - ix). Confirm that the Contractor is familiar with Amtrak's Operations and Maintenance environment; and
 - x). Identify any Contractor early needs for information or decisions required from Amtrak.
- b). Five (5) days before scheduled Kickoff Meeting, the Contractor shall submit the Kick-off Meeting Presentation. **[CDRL 3-04]**
- c). Within 30 days after NTP, a detailed Specification Review (chapter by chapter) shall be conducted to address:
- i). Any outstanding questions the Contractor may have regarding the Technical and Commercial Specifications requirements.
 - ii). In addition to the Contractor, all key subsystem suppliers shall participate.
 - iii). The Contractor and applicable subcontractors and suppliers shall be required to sign off indicating its understanding of each specification section.

3.9 Project Review Meetings (PRM)

- a). PRMs will be held at least monthly and will provide a forum to assess specific issues or to review issues that may have an impact on the design.
- b). These review meetings will analyze and address both technical and commercial issues for which agreement could not be reached during DRMs.
- c). The meetings will be attended by Contractor and Amtrak, and possibly external stakeholders designated by Amtrak or Contractor, e.g. FRA.
- d). These meetings have two objectives, first to allow the participants to maintain a close involvement in the project's development, and second to allow Contractor's project team to answer questions and resolve issues that arise during the project.
- e). The PRM shall achieve these goals by:
 - i). Reviewing Contractor's project progress report and ensuring that appropriate responsibility for actions is agreed upon
 - ii). Ensuring that the Trainsets comply with the quality, safety and technical matters of the Contract
 - iii). Identifying contractual matters which could potentially affect Contractor's performance

- iv). Identifying any major concerns regardless of source and ensuring that appropriate actions are agreed to facilitate resolution of such concerns
- v). Review any emerging issues.
- f). The agenda for these meetings will not be fixed but will be customized for critical issues at hand.
- g). Amtrak shall circulate an agenda at least one week prior to each meeting. Appropriate data packages covering the information to be discussed shall be submitted by Amtrak and Contractor prior to the upcoming meeting.
- h). Attendees:
 - i). Amtrak and Contractor's Project Director shall attend the meeting.
 - ii). Other members of Amtrak and Contractor's organizations may attend as required.
 - iii). Contractor shall ensure that persons knowledgeable in the topics to be discussed, including the appropriate subcontractors, are present as required at these meetings.
- i). All participants will have an opportunity to include on the agenda any issues that they deem important and in need of resolution at the meeting.
- j). Meeting notes and action lists will be produced by Amtrak for each review meeting to allow issues to be followed up at subsequent meetings.
 - i). Amtrak shall provide the draft minutes and action list to the Contractor for review.
 - ii). After revision, the minutes and action list shall be formally submitted to the Contractor and entered into the contract record.

3.10 Master Project Schedule (MPS)

- a). The Contractor shall be required to use Oracle Primavera P6 to produce the Master Project Schedule (MPS) Baseline, and all schedule updates, revisions, look ahead schedules, recovery schedules, and Time Impact Analysis schedules.
- b). Baseline Master Project Schedule (MPS): The Baseline MPS **[CDRL 3-05]** and an associated narrative shall be submitted to Amtrak no later than 30 days after NTP for Amtrak's review and approval.
- c). The MPS and associated narrative shall detail the Contractor's approach to meeting the required contractual project milestones.
- d). The MPS requirement is established to ensure adequate planning, scheduling, management, and execution of the Work by the Contractor and to enable Amtrak to evaluate Work progress.

- e). The MPS shall encompass the Contractor's total execution of its Contract with Amtrak and shall be updated and submitted monthly to reflect actual versus planned progress for each item listed.
- f). Work items shall be discrete items of Work accomplished during the performance of the Contract and that, when complete, produce definable, recognizable entities or stages within the project.
- g). The Baseline PS shall include detail activities for all scope and deliverables listed in the Contract, including but not limited to:
 - i). All Contractual Milestones and Key milestones and events, including those identified in the Contract Specification
 - ii). Projected Payment Milestones dates
 - iii). Necessary points of required input from Amtrak or third parties
 - iv). Activities for procurement of each subcontractor, with a milestone for Contract signing for each subcontractor
 - v). Contractor and Subcontractor/Supplier submittals including review cycles
 - vi). Project Design Review meetings
 - vii). Drawing packages requiring approval, with separate activities for "preparation", "submission", and "Amtrak review".
 - viii). Any regulatory approval periods shall be visible activities with durations
 - ix). All major off-site inspections and approval tests
 - x). All major steps of car body and truck fabrication
 - xi). All major subsystem fabrication and deliveries
 - xii). All assembly milestones
 - xiii). All deliverables
 - xiv). All progress milestone payments
 - xv). All CDRLs including but not limited to; design drawings, procedures, functional descriptions, and other documents required to be prepared by the Contractor and reviewed and accepted by Amtrak.
 - xvi). Activities for each test required by Contract, for each car
 - xvii). Activities for conditional acceptance of each car
- h). Where a given contractual deliverable or requirement must be completed for each car, separate activities must be included for each car.

- i). Additional Baseline MPS requirements:
 - i). The Baseline MPS start date shall be the Contract NTP date, and the schedule shall not show any activities with dates prior to NTP.
 - ii). The Baseline MPS shall include a 7-day work week calendar, which is applied to all contractual milestones.
 - iii). The Baseline MPS shall also include a 5-day work week calendar with holidays which is applied to all work activities.
 - iv). All activities in the schedule, with the exception of NTP, shall be assigned at least one appropriate predecessor activity.
 - v). All activities in the schedule, with the exception of the Final Completion milestone, shall be assigned at least one appropriate successor activity.
 - vi). The majority of logic relationships must be “finish-to-start”.
 - vii). While the use of lags is acceptable, overuse is not; only a small percentage of logic relationships may use a lag. Negative lags, or leads, are not acceptable.
 - viii). No date constraints may be used. Float constraints, such as “Finish on or Before” may be used if appropriate.
- j). The Baseline MPS shall include a detailed schedule narrative including:
 - i). The general approach to the project and schedule, design, fabrication, manufacturing, assembly and methods, inspection, testing, shipping, delivery, and approval.
 - ii). A description of the critical path, and all near-critical paths, which are paths in the logic network with 2 weeks or less of total float.
 - iii). A listing and descriptions of all project risks to the schedule
 - iv). Any required mitigation to address project delays
 - v). A section describing the status of all key / contractual milestones

3.11 Project Progress Schedule Updates

- a). The MPS and an associated narrative shall be updated and submitted on a monthly basis by the Contractor to accurately reflect current project progress status.
- b). Actual start dates and actual finish dates are to be entered, and remaining durations reduced as appropriate.
- c). All initial baseline dates shall remain listed on the schedule status reports in order

to measure performance.

- d). All actual dates must be before the data (schedule revision) date.
- e). Activity IDs can never be changed in a schedule update.
- f). The data (schedule revision) date of each schedule update shall be the first day of the month, and the schedule update shall be submitted to Amtrak on or before the 10th of each month.
- g). A schedule narrative shall be provided each month, and shall include:
 - i). The status of all contractual / key milestones
 - ii). A discussion of the overall current schedule status and causes of any schedule impacts, with suggested mitigations.
 - iii). A discussion of progress made during the update period.
 - iv). A listing of work planned in the coming update period.
 - v). A description of the current critical path, and near-critical paths, with reasons given for any change to the previous update's critical path
 - vi). In the event that a schedule revision identifies a slippage beyond a contractually required milestone, the narrative shall include a detailed description of the reason for the slippage and the mitigation proposed by the Contractor to bring the MPS back into compliance.
 - vii). Non-compliance with key milestones such as pilot car delivery or car production may result in a request for a Recovery Schedule per Section 3.10.
 - viii). A section that lists all Amtrak schedule comments, with responses to those comments.
 - ix). An appendix which lists all changes made to the schedule, with a reason given for each change. The changes that must be listed and explained are:
 - (1) Added activities
 - (2) Deleted activities
 - (3) Changes to original durations
 - (4) Added logic ties
 - (5) Deleted logic ties
 - (6) Any changes to constraints
 - (7) Changes to activity descriptions

- (8) Changes to calendar assignments.
- h). Revised MPS submittals do not relieve the Contractor of any schedule requirements as outlined by the Contract.
- i). Changes to any schedule related Contract requirements can only be obtained by the formal change order process in the General Provisions.

3.12 Recovery Schedule

- a). If any schedule update is forecasting for the project to be late, Amtrak may require the Contractor to submit a recovery schedule to Amtrak for review and approval.
 - i). The Recovery Schedule shall be submitted within 21 calendar days of the request.
 - ii). The recovery schedule shall be accompanied by a narrative that describes in detail how the Contractor is planning to recover time.
 - iii). All changes made to the schedule to recover time must be listed and explained.

3.13 Design Review Overview

- a). Purpose
 - i). Design Review, including the Industrial Product Design Review, will be a robust mechanism through which the Contractor shall develop, submit and receive approval for the designs necessary for the manufacture and supply of the Trainsets.
 - ii). Design Review is intended to:
 - (1) Determine whether Contractor has identified and understands the technical requirements
 - (2) Determine whether Contractor has identified an adequate approach to demonstrate that each design requirement has been or will be met.
 - (3) Determine whether Contractor has identified all interfaces and has a comprehensive System Integration approach.
 - (4) Observe the relationship between Contractor and major suppliers and to ascertain that Contractor provides adequate technical oversight;
 - (5) Determine the state of Contractor's Quality Assurance program; and
 - (6) Determine the readiness of the design and Contractor to proceed to the next stage of the design, manufacturing and testing.

- (7) Determine if the Contractor has understood the interior design ambition set out in the Customer Experience Vision Book (Exhibits F, F1 and F2) and understood the Amtrak brand purpose and values of the Amtrak Long Distance DNA.
- iii). The Contractor must recognize that the Design Review Process shall not be used to seek approval or authorization for deviations from any Contract requirements for the design of the Trainsets.
 - (1) Such changes will be handled in accordance with the General Provisions to the Trainset Contract, including without limitation Article 15 ("Changes") and Schedule 3 Change Request Process.
- b). General
 - i). The design review process shall begin no later than three months after NTP.
 - ii). The overall Design Review Process shall consist of three sequential stages (see Section 3.11 for additional detail):
 - (1) Preliminary Design Review (PDR)
 - (2) Intermediate Design Review (IDR)
 - (3) Final Design Review (FDR).
 - iii). The Design Review process shall also include an Industrial Product Design Review (IPDR), which shall run separately, but in parallel with the overall design review process. The IPDR shall also consist of three sequential stages (see Section 3.14 for additional detail):
 - (1) Preliminary IPDR
 - (2) Intermediate IPDR
 - (3) Final IPDR.
 - iv). Design review activities shall continue throughout the entire pre-production period, with each succeeding stage presenting greater amounts of detail and reflecting the progress of the designs.
 - v). As a minimum, each design review package shall be completed and approved, including Contractor's resubmission of design documents with revisions in accordance with detailed review comments, before progressing to the next review process.
 - vi). The Contractor shall be solely responsible for the vehicle design, including all sub-systems and materials.
 - (1) The Contractor shall be responsible to ensure that all systems, components, parts, and other equipment furnished by different

subcontractors shall function as intended when installed and integrated in each car.

- (2) The Contractor shall provide equipment meeting all specified performance levels and be compatible with all elements of the railway system on which Amtrak will operate the equipment, for the useful life of the equipment.
- (3) Safety, reliability, ease of maintenance and compatibility with any of Amtrak's existing locomotives is imperative.
- (4) The Contractor shall submit the design of all components being purchased from third party suppliers for review and discussion at the design review sessions.

c). Trainset Design Review Area Features

- i). The Trainset features / Systems / Sub-systems that will be subject to design reviews, include, but are not limited to, the following:
 - (1) Transverse disciplines:
 - (a) Gauge/clearance calculation
 - (b) Safety
 - (c) RAM (Reliability, Availability and Maintainability)
 - (d) EMC (Electro Magnetic Compatibility)
 - (e) ADA (Americans with Disabilities Act) and accessibility
 - (f) Acoustics
 - (g) Dynamic behavior
 - (h) Fire and smoke performance
 - (i) Serviceability/Maintainability
 - (j) Climatic adaptation
 - (k) Aerodynamics and cross wind calculations
 - (2) Mechanical disciplines:
 - (a) Virtual Mock-Up Review
 - (b) Weight calculations
 - (3) Interiors and Industrial Product Design:

- (a) Interior car arrangement
 - (b) Aesthetic design
 - (c) Customer experience
 - (d) Usability
 - (e) Interaction and functional design
 - (f) Ergonomics and human factors
 - (g) Color material and finish (CMF)
 - (h) Branding and Brand Application
 - (i) Mock-Up Review
 - (j) Employee Accommodation Rooms
 - (k) ADA accessibility review
- (4) Sub-systems:
- (a) CBS (Car Body Shell) for each different carbody arrangement, including floor System and FEA (Finite Element Analysis) calculations
 - (b) Fire protection System/extinguisher
 - (c) HVAC (including air flow calculation) passenger cars and cab
 - (d) Lighting
 - (e) Luggage racks and storage
 - (f) Passenger Seats, all types
 - (g) Booth Seats
 - (h) Lounge Seating
 - (i) Sleeping Accommodations, all types including accessible and non-accessible
 - (j) Roomette Modules
 - (k) Solo Suite Modules
 - (l) Bedroom Modules
 - (m) Toilets

- (n) Showers
 - (o) Food Service serveries and food preparation areas, including the café, the lounge and the dining car.
 - (p) Glazing
 - (q) Signage
 - (r) Public address, passenger information, intercommunication, WiFi and entertainment
 - (s) Digital technologies
 - (t) Diagnostics
 - (u) Cybersecurity
 - (v) Communications
 - (w) Video Surveillance
 - (x) Doors (Passenger access and interior doors) and steps
 - (y) Lifts and elevators
 - (z) Gangway & articulation
 - (aa) Couplers and draft gear
 - (bb) Battery and battery charger
 - (cc) Brake System
 - (dd) Wheel slide protection
 - (ee) Water and Waste system
 - (ff) TCMS (Train Control and Monitoring System)
 - (gg) Electrical cubicles & harnesses
 - (hh) Truck to Carbody Connection
 - (ii) Trucks
 - (jj) Maintainability Demonstrations
 - (kk) Mock-Up Review, all car types
- d). Design Review Process Governance

- i). The Contractor and Amtrak will work closely together in a collaborative way to ensure that the final design of the Trainsets meets the contractual requirements and resolve any technical problems or issues that may arise during the project.
 - (1) The requirement of section 3.11.d.i of the technical specification. does not relieve the Contractor of its sole responsibility to design, build and deliver trainsets in total compliance with the requirements of this Contract.
- ii). This collaboration will be via:
 - (1) A continuous involvement by Contractor with Amtrak and stakeholders to resolve and validate all of the design-related issues that arise during the project, through the review meetings
 - (2) Specific meetings where detailed analyses are reviewed by the parties for complete areas
 - (3) A review of deliverables (including, where appropriate, but not limited to, drawings, 3D data or models, assembly drawings, technical descriptions, calculation notes, studies, electric diagrams, pneumatic diagrams, test procedures and operation and maintenance documentation) to be submitted for review.
- e). Design Review Plan
 - i). Within 30 days of NTP, the Contractor shall submit for Amtrak review and approval Design Review Plan (DRP) detailing the performance of the engineering design objectives, detailed submittal schedule, functions, processes and procedures throughout the design process. **[CDRL 3-06]**
 - ii). Design Review will begin once the DRP has been accepted by Amtrak.
 - iii). At a minimum, Design Review will continue throughout the entire pre-production period until acceptance of the pilot trainsets to ensure:
 - (1) No objection by Amtrak to the proposed Trainset design in order to enable Contractor to procure materials and equipment to support the start of production of the Trainsets
 - (2) Amtrak's approval of a comprehensive, final set of fully representative drawings, 3D Models and Sub-system technical/functional Specifications.
 - iv). The Design Review Plan shall include at a minimum:
 - (1) Definition of the organization and relationships within the engineering team, with identification of the subgroups as organized by function or system.

- (2) Definition of the relationship of the engineering team to the overall organization of the Contractor.
 - (3) The relationship between the engineering team and collaborative teams such as the testing team and the production process team.
 - (4) Critical path/workflow plan for completion of all engineering functions.
 - (5) A well-defined list of deliverables for each design review stage that Contractor will submit to Amtrak to comply with the requirements of this Contract and in coordination with the MPS.
 - (6) The schedule for the progress and completion of major design activities including, but not limited to:
 - (a) All stages of design reviews;
 - (b) Mock-up review;
 - (c) Finalization of engineering;
 - (d) Test plan development;
 - (e) Car shell stress and structural performance analyses;
 - (f) Proof of design testing;
 - (g) Delivery of all required engineering documentation.
 - (7) Oversight of subcontractor and supplier engineering functions and integration of supplier engineering into the Contractor's design and design process.
 - (8) Manufacturing engineering plan, including assembly station work scope, parts flow and estimated labor hours/station staffing plan. A comprehensive manufacturing engineering plan shall be submitted to Amtrak for review.
 - (9) Car shell engineering plan, including design, finite elements analysis, quasi-static and dynamic testing, measurement of critical dimensions, acceptance and shipment, and inspection/repair procedures.
 - (10) Completed car weight control plan.
- f). Design Review Packages
- i). At least 30 days prior to the start of the design review process, the Contractor must submit to Amtrak for review and approval a detailed Drawing Tree **[CDRL-3-07]**

- (1) The drawing tree shall include all production, assembly and component drawings that are expected to be produced at all levels including unique drawing identification for each level.
 - (2) It is the intention that this drawing tree will be utilized to ensure all drawings have been submitted to Amtrak for review and approval throughout the design review process.
 - (3) At least the top 4 levels of drawings shall be provided by the Contractor prior to Intermediate Design Review.
 - (4) Modified top 4 level drawings and all subsequent other levels of the approved drawing tree shall be submitted with additional detail prior to Final Design Review.
 - (5) Final Design Review will not be approved until a full package of all production drawings is submitted and approved by Amtrak.
- ii). Design review documentation will be submitted on an ongoing basis prior to the formal design package being submitted.
 - iii). For each Design Review Meeting the Contractor shall submit a design review package at least thirty (30) days prior to the performance of the corresponding DRM.
 - (1) Amtrak will review the design review package with the goal of providing advance comments to the Contractor prior to the DRM.
 - iv). No DRM will be held without the entirety of the design package in question having been provided to Amtrak.
 - v). In the event of a late or insufficient documentation submittal, Amtrak shall determine if a delay of the corresponding meeting is necessary.
 - vi). If, for any reason, any particular design review package and its approval falls on the critical path and/or may put the Contract Time Plan at risk, Contractor will promptly notify Amtrak with sufficient advance notice in order that appropriate review prioritizing actions will be mutually agreed and implemented to expedite the design review.
 - vii). In all submissions and at all sessions, the Contractor and supplier presentations shall be organized to show exactly how the design meets each specific requirement of the Technical Specification.
- g). Design Review Meetings (DRM)
 - i). All design review meetings shall be held at an Amtrak facility unless otherwise mutually agreed to by Amtrak and the Contractor.
 - ii). Amtrak will record the minutes of each design review meeting, and within two weeks of the meeting shall provide a package that shall include the

- meeting minutes and a copy of all documents that the Contractor presented and/or discussed at the meeting.
- (1) Meeting minutes shall also include a summary of action items generated at the meeting. Items shall be referred to as action items if action or a decision is pending at the time that the minutes are issued.
- iii). An action items matrix shall be maintained by Amtrak that includes both Contractor and Amtrak open action items.
 - (1) The action items matrix shall include technical references, the open item description, action required, responsibility and status (open or closed).
 - (2) The open items on the action items matrix shall be reviewed at each design review meeting and regularly after Final Design Review (FDR) meetings until all items are closed.
 - iv). Each design review meeting shall include adequate time to properly walk through the entire System Functional Description at a minimum while utilizing drawings, 3D models and virtual reality to further explain the designs being presented.
 - v). Subsequent design review meetings shall be scheduled if the first design review meeting is deemed unacceptable by Amtrak.
- h). Formal Design Review Response/Comments
- i). Amtrak will complete the design review and issue its formal review comments/submission as expeditiously as possible.
 - ii). Amtrak's formal design review response will take in to account the issues progressed/closed out during the DRM as well as any open action documentation received following the DRM.
 - iii). Amtrak's formal response to the design review package will include a status as per Figure 3-1 which will govern the Contractor's authorization to progress.
 - iv). The required review by Amtrak of all Contractor submitted design documentation does not relieve the Contractor of any of its contractual design responsibility.
- i). Design Review Submission Statuses
- i). Upon review of design submittals, Amtrak shall respond to the Contractor with comments and a submittal status. Status categories are as follows:

Figure 3-1: Design Review Submittal Statuses

For Information	The submittal has been reviewed for information and does not require a formal status
Rejected	The submittal does not demonstrate the minimum level of content, completeness, or quality. The submittal must be completely revised and resubmitted. The Contractor shall not progress to the next phase of the design process or manufacturing.
Revise and Resubmit	Specific comments are provided for the Contractor to address in the revision and resubmittal of the submittal. The Contractor shall not progress to the next phase of the design process or manufacturing.
Conditionally Accepted	Specific comments are provided for the Contractor to address in the revision and resubmittal of the submittal. However, the design has reached a completeness to allow progress to the next phase of the design process and/or manufacturing. However, design progression or manufacture related to the remaining open comments are at the Contractor's risk.
Accepted	The design submittal is considered closed. The Contractor may progress to the next phase of the design process and/or manufacturing.

j). Weekly Engineering Meetings

- i). The Contractor shall participate in weekly engineering meetings to discuss current, relevant technical issues, challenges with the ongoing systems' design and any other pertinent technical concerns.
- ii). At times during the design review process, additional specific engineering meetings may be required.

k). Weekly Industrial Design Meetings

- i). The Contractor shall participate in weekly industrial design meetings to discuss current, relevant industrial design issues, challenges with the ongoing industrial design and any other pertinent design concerns.

l). Additional Design Review Communications

- i). In addition to Project Review Meetings (PRM), Design Review Meetings (DRM) and Weekly Engineering Meetings, the Contractor's technical project team shall maintain continuous communication with Amtrak and its stakeholders.

- (1) This communication may be by telephone, e-mail, video conference, or face-to-face meetings.
 - (2) This communication will be used to highlight potential issues, including Contractor assumptions, conceptual design solutions, and comments on the emerging designs.
 - (3) These communications are intended to provide an efficient process for providing directions on a regular basis, allowing the participants to maintain a close involvement in the project.
 - (4) The Contractor is reminded, however, that design approval must be documented in formal Contract correspondence.
- m). Changes to Approved Designs
- i). If the Contractor wishes to propose a deviation from a previously approved design, a request for change shall be submitted to Amtrak for review and approval prior to introducing any change to the accepted configuration.
 - (1) The Request for Change shall be made per the requirements of the General Provisions and shall include revised drawings and data substantiating the suitability of the design.
 - ii). Any component changes to form, fit, or function subsequent to design reviews shall be updated in the documentation and resubmitted to Amtrak.
 - (1) The implementation of any change which deviates from the design, arrangement and/or configuration previously approved by Amtrak without prior submission and approval by Amtrak may require rework or replacement back to the approved design.
 - (2) The determination of the necessity for rework shall be solely at the discretion of Amtrak.

3.14 Amtrak Involvement

- a). Amtrak shall be an integral part of all aspects of the design, inspection, testing and approval program for the cars.
- b). Amtrak shall designate staff or representatives to participate in the design review and inspection process on behalf of Amtrak.
- c). Amtrak shall have the right to invite or permit to participate in any design review, audit or test anyone Amtrak deems appropriate.
- d). Individuals or entities designated by Amtrak including, but not limited to the Federal Railroad Administration (FRA), shall be afforded all desired access to the project, including design reviews, witnessing of tests and audits.
- e). Only those individuals, designated in writing by the Contracting Officer's Technical

Representative (COTR), shall have the authority to take actions on behalf of Amtrak that relate to the DRP, including, but not limited to, approvals, acceptances and providing design review comments.

- f). The Contractor shall not recognize the actions of those individuals not so designated in writing.
- g). Amtrak will give Contractor reasonable notice of stakeholder participation but reserves the right to include participants without notice.
- h). Amtrak's participation, review and approval shall be necessary for:
 - i). Design review and evaluation
 - ii). Supplier selection,
 - iii). QA program review and approval
 - iv). Supplier Quality Audits
 - v). First article inspection and approval
 - vi). Inspection of all phases of car production
 - vii). Testing
 - viii). Car and Trainset acceptance
 - ix). Sample selection
 - x). Post-delivery training
 - xi). Warranty administration.

3.15 Design Review Stages

- a). General
 - i). The requirements for the three Design Review phases are summarized in Sections:
 - (1) 3.15c). Preliminary Design Review (PDR)
 - (2) 3.15d). Intermediate Design Review (IDR)
 - (3) 3.15e). Final Design Review (FDR)
 - ii). Progression from PDR to IDR and IDR to FDR, may be done on a system-by-system basis, with the approval of Amtrak, otherwise the progression shall follow the requirements of Sections 3.15c), 3.15d), and 3.15e).

- iii). Mockups, Virtual Reality, product accommodations and CMF reviews shall be incorporated into the three design reviews.
- b). Compliance Matrix **[CDRL 3-08]**
 - i). Beginning with PDR, the Contractor shall develop and maintain a matrix showing all standards, regulations, and technical requirements of the Contract and the Contractor's proposed design and/or component to meet each requirement.
 - ii). The compliance matrix shall be maintained throughout the three Design Review stages.
 - iii). Contractor will report the progress against the compliance matrix as one of the first steps of each design review meeting.
 - iv). The compliance matrix portion of the design review for each Sub-system/design area will cover regulatory compliance, compliance with industry standards and compliance with the technical requirements of the contract.
 - v). The matrix shall include the detail of where in the design review documentation each compliance is validated.
 - vi). The compliance matrix shall outline all non-compliances with the technical specification at the time of Contract Award. Any non-compliance identified after Contract Award shall be handled via the Change Review Process.
 - vii). Non-compliances identified after Contract Award may not be accepted by Amtrak.
 - viii). Post-Contract Award non-compliances that are accepted by Amtrak and result in a savings to the Contractor shall be commercially credited to Amtrak.
- c). Preliminary Design Review (PDR)
 - i). The PDR of the Trainset design will be performed to bring the design of the Trainset to approved 30% competition and will provide an overview of the design. **[CDRL 3-09]**
 - ii). Review of the Trainset concept in the PDR stage of the project will include as a minimum, presentation of layouts, car body structure, external livery, interior design proposals, brief technical description of features / Systems / Sub-systems, truck concept and materials (e.g. electric, pneumatic).
 - iii). The PDR presentations will include a review of the design concept, written descriptions of the functionality, schematics and/or block diagrams of the System wiring, arrangement drawings and technical specifications and drawings of each major System and component as applicable to this design phase and the deliverables listed in Section 3.13.

- iv). The objective is to conduct an initial analysis of proposed design solutions based on parameters such as functionality, performance, maintainability, software logic, ease of cleaning, reliability, security, etc., so that potential changes are identified as early as possible.
- v). Amtrak retains the right to redline, comment, and request changes to improve design and/or functionality.
- vi). PDR submittals and activities shall comprise but are not limited to the following:
 - (1) Compliance Matrix **[CDRL 3-10]**
 - (2) Drawing Tree and Schedule **[CDRL 3-11]**
 - (a) A drawing schedule, based on the drawing Tree required in 3.10 n., for all distinct releases covering the design of all areas and subsystems of the cars in conformance with the Contractor's configuration management plan shall be prepared prior to the start of the PDR and submitted to Amtrak for approval.
 - (b) Each release shall be given a proper title for the top drawing and a drawing number.
 - (c) Arrangement drawings to be developed during the PDR shall also appear on this schedule with a title and number.
 - (d) The drawing schedule shall be immediately updated to reflect any revisions.
 - (e) At a minimum, the Contractor shall provide the initial release drawings of the top 4 levels of the drawing tree for review during PDR.
 - (3) System Functional Description **[CDRL 3-12]**
 - (a) A detailed system functional description including dimensions and layout drawings.
 - (4) Arrangement Drawings and Related Documents **[CDRL 3-13]**
 - (a) During PDR arrangement drawings and related documents of the cars and all major subsystem hardware items as described above shall be submitted to Amtrak for review and approval. Drawings shall show at a minimum:
 - (i) Overall dimensions, orientation, center of gravity, weight, points of normal support, and method of support during mounting and removal.

- (ii) Location of all doors, access panels and covers in relation to any enclosed equipment.
 - (iii) Required space for opening of all doors and access panels.
 - (iv) Location and space requirements for ventilation intake and exhaust openings and cable entrances.
 - (v) Location and space requirement for all major equipment.
 - (vi) Conceptual interior and exterior renderings, including CMF and product accommodation.
 - (vii) CMF Palette
 - (viii) Layout of Product Accommodations
- (5) Detailed Technical Specification **[CDRL 3-14]**
- (a) No later than 30 days prior to the first PDR meeting, the Contractor shall submit detailed technical specifications for all major systems and components.
- (6) Review Program
- (a) The Contractor shall submit to Amtrak an interim detailed technical specification **[CDRL 3-15]** covering the methods, materials and arrangements proposed for construction of the pilot cars.
 - (i) The document shall be similar in style and format to this Technical Specification, which shall take precedence in the event of any differences.
 - (ii) An appendix shall give a complete tabulation of all suppliers and the products each is supplying and shall also include an update to the pre-award Buy America submittal, indicating any revisions to the manufacturer of goods and country of origin. **[CDRL 3-16]**
 - (b) After approval by Amtrak, it shall be updated by the Contractor every 30 days to continuously represent the current configuration of the details of the car, including all specification changes and addendums.
 - (c) A monthly revision sheet shall contain a complete listing of the original and revised text, and details of the approval given by Amtrak.

- (d) During the design review process, Amtrak may request a 3D model of specific components such as a coach seat or a roomette module.
 - (i) 3D files shall be provided in a neutral file format such as STEP or IGES.
 - (ii) 3D files shall be provided within 10 days of request.
 - (7) Weight Analysis **[CDRL 3-17]**
 - (a) After receipt of the approved minutes of the first design review meeting the Contractor shall submit to Amtrak a report on the estimated car weight. The document shall then be revised and resubmitted to Amtrak at intervals agreed to with the car builder until the complete weighing of the pilot car.
 - (b) This shall include the most recent weights for the car body without trucks, each truck, and the complete car.
 - (c) It shall also include a list of weights for every subsystem on the car, indicating its percentage of the total car weight, and if these subsystem weights are based on actual scale weights of complete equipment.
 - (d) The Contractor shall weigh all components as early as possible.
- d). Intermediate Design Review (IDR)
 - i). The IDR will be held when the design of the Trainset is approximately 60% complete. **[CDRL 3-18]**
 - ii). The IDR will represent an advancement of the design of the Trainset from the PDR to development of: draft production drawings, arrangements, component and material specifications, and schematics for all Systems (Sub-systems and components) on each Vehicle type as applicable to this design phase and as agreed by the parties in the design review program.
 - iii). This information will be used by Amtrak to evaluate the proposed design of the Trainset to a level of detail sufficient that Contractor will be able to proceed with the development of the Trainset design to the 90% draft final stage.
 - iv). The intent of the IDR is to present and provide all Sub-systems and their credentials, review of in-depth System and functional descriptions, review of main layouts (e.g. roof, under frame, body sides, traction System, software logic, auxiliaries, interiors etc.), calculations and simulations, consumptions and functionality (e.g. electrical diagrams).
 - v). IDR submittals and activities shall comprise but are not limited to the following:

- (1) The continuation and updating of all activities specified as ongoing in the PDR, i.e., weights analysis, updated technical specifications, functional analysis, drawing schedule, arrangement drawings and supplier identification.
- (2) Submission of all documentation identified for IDR on the Design Review Summary Matrix below.
- (3) Detailed Drawings and Related Documents
 - (a) The Contractor shall submit as a minimum the following detailed drawings and related documents to Amtrak for review and approval:
 - (i) All drawings identified in the approved Drawing Tree, properly dimensioned, detailed, to scale and in accordance with the approved drawing schedule. **[CDRL 3-19]**
 - (ii) Provide all updated drawings that reflect changes from the PDR meetings as well as provide at least two additional levels of the drawing tree for review and approval by Amtrak. **[CDRL 3-20]**
 - (iii) During IDR, it is expected that drawings shall present manufacturer and model information for all material called out on the BOM of each drawing. Identification of a generic or unspecified component will not be acceptable.
 - (iv) Draft single line control schematic **[CDRL 3-21]** and functional block diagrams for each subsystem **[CDRL 3-22]**, and electrical wiring diagrams and schematics **[CDRL 3-23]** for all electrical circuits.
 - (v) A complete set of draft drawings related to clearance. **[CDRL 3-24]**
 1. These shall include static and dynamic envelopes relative to the wayside allowances, including clearances for all parts of the truck, and general arrangement drawings with all static dimensions including camber, low level platforms, high level platforms, curves, etc.
 - (vi) Single line piping and flow diagrams for all pneumatic circuits, displaying all valves and control components. **[CDRL 3-25]**
 - (vii) Manufacturer's data and specification sheets on all control items. **[CDRL 3-26]**

- (viii) Updated Compliance Matrix **[CDRL 3-27]**
 - (ix) Update interior and exterior renderings **[CDRL 3-28]**
[CDRL 3-29]
 - (x) CMF Palette **[CDRL 3-30]**
 - (xi) Interior Material Samples **[CDRL 3-31]**
 - (xii) Layout of Product Accommodations **[CDRL 3-32]**
 - (xiii) Draft maintenance requirements and necessary procedures for all equipment in each subsystem. **[CDRL 3-33]**
 - 1. These shall be listed from daily inspection and periodic inspection to complete overhaul, with frequency and time needed to service being tabulated, and shall highlight all FRA-required inspections.
- vi). Amtrak comments from the PDR stage shall be reviewed, and the Contractor shall provide documentation that Amtrak's comments were incorporated into the car design.
- (1) All drawings, specifications, schematics, and other project documentation shall be updated for the IDR.
 - (2) Once reviewed, the drawings and designs shall be updated to incorporate Amtrak comments.
- e). Final Design Review (FDR)
- i). The Final Design Review (FDR) of the system components shall be held at the 95% or greater percent level of design and IDR has been closed out. **[CDRL 3-34]**
 - ii). FDR in summary will provide for an in-depth review of System and function descriptions, schematics of the system wiring, drawings of each assembly, sub-assembly, component, and sub-component showing dimensions and structural elements, calculations and simulations, weight estimates, consumptions, full functionality, final layouts, specifications, drawings, diagrams, test procedures and software functionality details.
 - iii). FDR submittals and activities will represent a continuation and updating of all activities specified as ongoing in the PDR, IDR and mock-up review as applicable to this design review stage.
 - iv). Redlines and comments from the IDR and mockup review shall be reviewed.

- v). Amtrak retains the right to provide additional comments during this process as production progresses and concerns are brought to Amtrak's attention.
- vi). FDR submittals and activities shall comprise but are not limited to the following:
 - (1) The continuation and updating of all activities specified as ongoing in the PDR, IDR, and mockup review, i.e.:
 - (a) Critical Path Method
 - (b) weights analysis [CDRL 3-35]
 - (c) detailed technical specification [CDRL 3-36]
 - (d) functional analysis [CDRL 3-37]
 - (e) drawing schedule [CDRL 3-38]
 - (f) arrangement drawings [CDRL 3-39]
 - (g) supplier identification [CDRL 3-40].
 - (2) Detailed Drawings and Related Documents — The Contractor shall submit as a minimum the following detailed drawings and related documents to Amtrak for review and approval:
 - (a) All drawings identified in the approved Drawing Tree, properly dimensioned, detailed, to scale and in accordance with the approved drawing schedule. [CDRL 3-41]
 - (b) Single line control schematic [CDRL 3-42] and functional block diagrams [CDRL 3-43] for each subsystem, and electrical wiring diagrams and schematics for all electrical circuits [CDRL 3-44].
 - (i) All test points shall be displayed.
 - (ii) The functional block diagrams shall identify the "normal" functional paths as well as the functional paths made available through cutouts, bypasses, and redundant circuits.
 - (iii) The diagrams shall identify, as a minimum, the critical hardware that permits safe movement of the car, safe ingress/egress of passengers, and essential environmental needs of the passengers and Operator.
 - (iv) The functional block diagrams shall display the levels of hardware (as defined in Military Specification MIL-HDBK-505) that identify the Lowest Level Replacement Unit (LLRU).

- (c) A complete set of drawings related to clearance **[CDRL 3-45]**. These shall include static and dynamic envelopes relative to the wayside allowances, including clearances for all parts of the truck, and general arrangement drawings with all static dimensions including camber, low level platforms, high level platforms, curves, etc.
- (d) Single line piping and flow diagrams for all pneumatic circuits, displaying all valves and control components. **[CDRL 3-46]** All test points shall be displayed.
- (e) Graphs and curves giving response and functional characteristics of the cars, subsystems, and major items. **[CDRL 3-47]**
- (f) Manufacturer's data and specification sheets on all control items. **[CDRL 3-48]**
- (g) Maintenance requirements and necessary procedures for all equipment in each subsystem. **[CDRL 3-49]**
 - (i) These shall be listed from daily inspection and periodic inspection to complete overhaul, with frequency and time needed to service being tabulated, and shall highlight all FRA-required inspections.
- (3) Stress Analysis — A Finite Element stress analysis (FEA) of the car body shall be submitted to Amtrak for approval, Chapter 6 for more detail. **[CDRL 3-50]**
- (4) Final Interior and Exterior Renderings **[CDRL 3-51]** **[CDRL 3-52]**
- (5) CMF Boards and Samples **[CDRL 3-53]**
- (6) Customer Experience Vision Book **[CDRL 3-54]**
- f). Design Review Summary Matrix
 - i). The Contractor shall be required to submit all documentation required by the requirements of 49 CFR 238.110 as listed in the Notice of Proposed Rule Modification for submittal to the FRA as required. **[CDRL 3-55]**

Figure 3-2: Design Review Summary Matrix

Element	Sub-Element	PDR	IDR	FDR
System Design	Functional Description	X	X	X
	Supporting Calculations & Analyses		X	X
	Contractor Specification	X	X	X
	Car body FEA Analysis		X	X
	Outline Drawings	X	X	X
	Exploded Isometric Drawings		X	X
	Interior Layout and Product Design	X	X	X
	Exterior Design and Livery	X	X	X
	Detailed Drawings		X	X
	Control schematic & functional block diagrams		X	X
	Clearance Drawings	X	X	X
	Piping and flow diagrams		X	X
	Component Details		X	X
	Technical Specification Data Sheets	X	X	X
	Installation Drawings		X	X
	Maintenance Clearance Drawings		X	X
	Bill Of Materials		X	X
	Complete list of LRUs		X	X
	Interface Analysis	X	X	X
	Interface Drawings		X	X
	Subcomponent & Supplier Information	X	X	X
	Subcomponent Drawings		X	X
	Fire Safety & Toxicity Analysis		X	X
	Weight Report	X	X	X
	EMI Susceptibility		X	X
	EMI Mitigation Plan	X	X	X
	Signage and Decal Plan		X	X
	Renderings	X	X	X
Virtual Mock-Ups	X	X	X	
Soft Mock-Ups	X	X		
Hard Mock-Ups		X	X	
Support	Training Requirements	X	X	X
	Training Plan and Syllabus		X	X
	Maintainability Report	X	X	X
	Maintenance Requirements	X	X	X
	Maintenance Documentation Plan	X	X	X
	Maintenance Documentation Drafts		X	X
	Spare Parts Requirements		X	X
CDRL	All	X	X	X
Testing	Test Plan	X	X	X
	Test Procedures		X	X

3.16 Industrial Product Design Review Stages

a). General

- i). Due to its high impact on the train design, Industrial Product Design shall be included through the Design Review process and will be addressed in each Design Review Phase.
- ii). Industrial Product Design shall include both interior design and exterior livery.
- iii). Industrial Product Design shall focus on design aspects including but not limited to:
 - (1) Aesthetics
 - (2) Customer experience
 - (3) Functional design
 - (4) Usability
 - (5) Interaction
 - (6) Ergonomics
 - (7) Comfort reviews
- iv). Throughout the Industrial Product Design, the Contractor shall provide details with regard to color material and finish (CMF) to ensure that the final accepted product design successfully delivers against Amtrak's brand palette, long distance brand DNA and the unique experience and spaces on our long-distance trains as is detailed in the Customer Experience Vision Book (Exhibits F, F1 and F2).

b). Industrial Product Design PDR Package

- i). The Contractor shall submit to Amtrak its proposal for interior design that matches the vision set out in the Customer Experience Vision Book across all areas of the train.
 - (1) The goal of the Industrial Product Design PDR is to evaluate the extent to which the Contractor has been able to achieve the ambitions and targets set out by Amtrak's design vision.
 - (2) Contractors shall provide options on how they aim to achieve the vision and can suggest improvements, innovations and ways in which to embellish the design directions further.
 - (3) The PDR package shall clearly demonstrate how the proposed design delivers an excellent customer experience while delivering high quality

- design implementation through simple construction methodology and materiality.
- (4) PDR meetings will be held throughout the PDR to ensure issues and challenges are addressed in a timely manner, helping to ensure that the design will meet Amtrak's ambitions.
 - (5) At PDR the expected deliverables are:
 - (a) First round of soft mockups **[CDRL 3-56]**
 - (b) First round rendering **[CDRL 3-57]**
 - (c) Initial color material and finish boards **[CDRL 3-58]**
 - (d) Clay model VR **[CDRL 3-59]**
 - (e) 2D layouts, including **[CDRL 3-60]**
 - (i) Dimensioned seating layouts of all cars that have Coach and Premium Coach car, including restrooms, storage and equipment cupboards, seating, seat counts, accessible spaces, and accessible pathways.
 - (ii) Side elevation showing Coach and Premium Coach seat positions and leg clearance and recline clearances on first and last row, and relationship to any accessible space.
 - (iii) Complete sleeper cars presenting the layout of all accommodation, room sizes, room counts, aisles and doorways sizes, detailing key dimensions.
 - (iv) Accessible room layouts showing all accessible pathways, turning circles, accessible spaces. Detailing key dimensions.
 - (v) 2D Layouts of all vestibules, gangways
 - (vi) 2D layouts of Café, Lounge and Diner Cars – showing seat counts, accessible spaces, and accessible pathways
 - (vii) 2D layouts of Food service arrangements for Kitchen, Bar, Café and Servery – listing out equipment placements
 - (6) Expected Industrial Product Design PDR tasks have been listed out separately below in Section 3.14.b.
- ii). Industrial Product Design PDR Tasks
- (1) Exterior Livery

- (a) At the start of PDR, Amtrak will provide the Contractor with its conceptual vision for the exterior livery of the trainsets.
 - (b) Livery shall be compliant with the requirements of the technical specification and the description included in the Customer Experience Vision Book.
 - (c) As part of PDR, the Contractor shall provide at least three (3) different designs **[CDRL 3-61]** based on the implementations of the conceptual vision.
 - (d) Exterior livery design review meetings shall be held as necessary to focus and fine tune the designs.
 - (e) Throughout the design review process, the Contractor shall submit revised side elevation artwork and exterior renderings for Amtrak's review.
 - (f) At each design review phase, Amtrak will review and comment on how the Contractor has interpreted the supplied livery into an actionable implementation of the design.
 - (g) The Contractor should expect to work collaboratively with Amtrak throughout the design review process to arrive at a final livery design during FDR.
- (2) Coach and Premium Coach Seating
- (a) The Contractor shall propose three different seating products from its preferred supplier for both Coach and Premium Coach seating. **[CDRL 3-62]**
 - (b) Amtrak is also looking for Contractors to recommend up to two (2) alternative seating suppliers and their products to allow Amtrak to products most suited to the intended service. **[CDRL 3-63]**
 - (c) The proposals shall detail the available level of customization of each of the proposed products.
 - (d) All proposed seats shall be made available to Amtrak during the PDR phase to examine and evaluate for features and comfort to facilitate the final selection the seating products.
 - (i) Seats may be made available either in the Washington DC area or at the manufacturers site.
 - (e) The seating proposals shall detail the expected seat comfort and ergonomics with a focus on both seated conditions and sleeping conditions.

- (f) As part of PDR, the Contractor shall present three (3) concept design routes for both Coach and Premium Coach seating types – showing seat cushioning details, stitch line treatments and representation of all seating feature sets as set out in the technical specification. **[CDRL 3-64]**
- (g) The Contractor shall submit a human factors study on the proposed seating products using ergonomics that represent 95% United States male and a 5% Japanese female percentile for both seating types in all seating conditions. **[CDRL 3-65]**
 - (i) The report shall detail how seat adjustments for headrest, knee, and leg clearances, reach zones and table heights and clearances.
 - (ii) Amtrak will use these studies in the selection of the final supplier and products.
- (h) Amtrak expects that the seating supplier and seating products shall be finalized by the completion of PDR.
- (3) Elevations and Top-Down Layouts **[CDRL 3-66]**
 - (a) These shall present ceiling, lighting, luggage rack, sidewall design with key dimensions and lighting positions.
- (4) Accessibility Proposal **[CDRL 3-67]**
 - (a) This shall present how the proposed design shall provide accessible spaces with features comparable to seated locations, including reading lights, tables, wheeled mobility device restraint options. etc.
 - (b) The study shall also validate each accessible space in relation to the accessible path, turning circles, transfer seats, etc.
 - (c) Any seat variant proposed for accessibility compliance shall be included in the proposal.
- (5) Contractors submittals shall:
 - (a) Execute the vision of the key room products as set out in the Customer Experience Vision Book and technical specification.
 - (b) Execute vision of restrooms, lounge, diner and food service areas as set out in the design book while implementing requirements set out in the technical specification.
- (6) Bedroom Seating

- (a) Submit to Amtrak for review and approval, three (3) concepts for bedroom seating. **[CDRL 3-68]**
 - (i) The submittals shall explore options for seat contouring and cushioning and stitch lines that consider both ergonomics and comfort.
 - (ii) Validate comfort using a stand-alone soft mock-up. **[CDRL 3-69]**
 - (iii) The submittals shall also show how look and feel of proposed seating provides visual consistency across all room types.
- (7) Sleeper Car Corridor Concepts **[CDRL 3-70]**
 - (a) The concepts shall have a focus on room door equipment, handholds and lighting solutions, beverage stations and interface with thresholds (vestibules, end doors staircases, elevators etc.)
- (8) Accessible Accommodation Validation
 - (a) Validate design solutions for all the Accessible bedroom types and the Accessible Restrooms as set out in the design vision and technical specification. **[CDRL 3-71]**
 - (b) Accessible Restrooms will need specific validation user testing at all soft mock-up stages. **[CDRL 3-72]**
- (9) Accessible Premium Bedroom Concepts
 - (a) The Contractor shall propose three (3) concept directions for the Accessible Premium Bedroom, each exploring a different layout configuration to accommodate the requirements set out in the technical specification. **[CDRL 3-73]**
- (10) Crew Bedroom Concepts
 - (a) The Contractor shall propose three (3) concept directions for the crew bedrooms, including various arrangements of crew storage **[CDRL 3-74]** area for testing with crew user groups. **[CDRL 3-75]**
- (11) Food Service Areas
 - (a) The Contractor shall provide a detailed presentation of all food service area areas including: **[CDRL 3-76]**
 - (i) Food preparation areas
 - (ii) Food preparation, storage, POS and transport equipment

- (iii) Food preparation workflow analysis
 - (iv) Customer facing areas
 - (b) The Contractor shall expect Amtrak to involve many stakeholders in the review of the proposed food service areas. This will include reviews of document packages as well as simulations using the soft and hard mockups.
- c). Industrial Product Design in IDR
 - i). In preparation for IDR, the Contractor will carry out regular reviews and updates with Amtrak to collaboratively fine tune the design and color palettes.
 - ii). The IDR package will further develop and prove out all color material and finish applications
 - iii). Mock-ups shall be revised to include the evolving CMF boards and supplier samples
 - iv). Expected deliverables are evolved/updated versions of the:
 - (1) Renderings **[CDRL 3-77]**
 - (2) 2D drawings **[CDRL 3-78]**
 - (3) VR environments **[CDRL 3-79]**
 - (4) Livery artworks **[CDRL 3-80]**
 - (5) Soft-mockups **[CDRL 3-81]**
 - (6) Sampling and color boards **[CDRL 3-82]**
 - (7) 1st Round Hard Mock-ups **[CDRL 3-83]**
- d). Industrial Product Design in FDR
 - i). For FDR of the Industrial Product Design, the Contractor will submit to Amtrak for review and approval:
 - (1) VR Environments **[CDRL 3-84]**
 - (2) Livery Artworks **[CDRL 3-85]**
 - (3) Hard Mock-ups **[CDRL 3-86]**
 - (4) Renderings **[CDRL 3-87]**
 - (5) Color Material and Finish Boards **[CDRL 3-88]**

- (6) Final Design Book **[CDRL 3-89]**
- (7) All approved physical samples of materials **[CDRL 3-90]**

3.17 Mockup Development and Review

a). Mockup and Rendering Review Plan

- i). The Contractor shall develop and submit a Mockup and Rendering Review Plan no later than thirty (30) days after NTP. **[CDRL 3-91]**
- ii). The Plan shall describe all mockups and renderings to be developed by the Contractor, the locations where the mockups will be built and reviewed, and the schedule for completion and review of the mockups and renderings.
- iii). Contractor may propose as an option to provide full-scale completed cars to satisfy the mockup requirements, subject to review and approval. For more mockup and rendering requirements see Sections 3.15, 3.16 and 3.17.

b). Mockups Overview

i). Purpose

- (1) The Contractor shall produce full-scale mock-ups for the purpose of presenting the design concepts for the exterior and interior of the various car types.
- (2) The mock-ups shall be used to demonstrate compliance with the specification requirements for passenger amenities and arrangements, passenger and crew ergonomics, access to equipment and controls, verification of lines of sight, accessibility of equipment for maintenance and passenger accessibility which shall be designed with Universal Design in mind and in compliance with ADA, Accessibility Specification for Transportation Vehicle, and 2010 (or newer) ADAAG Standard. and specification requirements.
- (3) The mock-ups shall also be used to help Amtrak finalize the Contractor's implementation of Amtrak's design vision and CMF.
- (4) The mock-ups shall be used to identify potential problem areas and facilitate the development of alternative solutions.

ii). General

- (1) The Contractor shall provide full-scale mock-ups of each of the different car types, including both levels, included in the procurement.
- (2) There shall be two types of each mock-up:
 - (a) Soft mock-ups shall be refined throughout PDR and IDR. (see Section 3.17c)

- (b) The hard mock-up shall be refined throughout IDR and FDR. (see Section 3.17d)
 - (3) Each car class/variant shall be represented by its own stand-alone mock-up rather than conflating elements from several car variants into one "mixed" mock-up.
 - (4) The mock-ups shall be of sufficient size to include all requirements included in this chapter, including, but not limited to those in Section 3.17e).
 - (a) Soft Mock-ups must also meet the requirements of Required Elements of Mockup Deliverables Section 3.17c).
 - (b) Hard Mock-ups must also meet the requirements of Section 3.17d).
 - (5) Each mock-up interior shall be complete with respect to details and shall show the location and arrangement of all components and devices.
 - (6) In the case of repetitive, identical features, such as roomettes or sleeper modules, the Contractor may build out one module interior and represent the others as closed off as viewed from the aisle.
 - (7) The Contractor may build additional mockups for Amtrak review at different points in the design review process, to assist in the development and finalization of the design.
- iii). Location
 - (1) The Contractor is responsible for supplying the facility for the mockups for the duration of the mock-up period.
 - (2) The mock-ups will be required to be built and presented within the Washington DC Metro Area at a location approved by Amtrak.
 - (3) The mock-ups must be presented in a space that is accessible and has accessible facilities.
 - (4) The location proposed for the mock-ups shall be attainable by public transportation.
 - (5) The location selected for the mock-ups shall be submitted to Amtrak for review and approval.
 - (6) Amtrak shall visit the proposed mock-up site prior to its acceptance of the proposed location.
- iv). Materials and Finishes

- (1) The initial presentation of the mock-ups may use materials that provide an indication of the equipment and component layout.
 - (2) As the design progresses, the materials and equipment shall be replaced with the final design components, except as specifically allowed by Amtrak.
 - (3) Equipment, controls and indicators may be represented by placeholders sized, shaped and colored as they would be on actual consoles.
 - (4) Except as otherwise indicated, all equipment shall be functional; but not required to meet the performance requirements.
 - (a) When powered, all indicators, lights, doors, fans etc., shall operate.
 - (5) Electronic equipment shall be wired to permit function (e.g., indicators illuminating or fans running) when powered by an external power supply.
- v). Electrical Power
- (1) The mock-up shall be provided with power supplies for the conditioning and conversion of power.
 - (2) Only 120 or 240 Vac power shall be necessary to be supplied to the mock-up.
 - (3) The Contractor shall specify the required amperage and install circuit protection for the incoming power.
- vi). Accessibility
- (1) The mock-ups themselves should be fully accessible and provide safe access for people with disabilities including those who use wheeled mobility devices, as well as deaf, hearing impaired, blind and low-vision.
 - (2) Mock-ups should be built with any necessary ramps to access points.
 - (3) Mock-ups should include the ability to test accessibility with user groups of people who use mobility devices.
 - (a) They shall provide an accurate representation of accessible space, including the features required in this area like table, reading light, seat reservation display.
 - (b) A seat should be available to safely test a transfer maneuver.

- (4) Soft mock-ups for accessible rooms and accessible restrooms should be built in such a way to test and validate various handhold locations and sizes, as well as all interaction point like screens, switches, and buttons.
 - (a) These features should be easily swappable and moveable in a single focus group setting.
- (5) Accessible restrooms should be in a suitable condition for testing by people who use wheeled mobility devices who will need to test transferring to toilets.
- (6) Accessible pathways, turning circles and accessible space requirements should be represented and marked on the floors of the mock-ups, including, but not limited to:
 - (a) Any access from platform to an accessible space or accessible bedroom.
 - (b) Routes from accessible spaces to accessible restrooms
 - (c) Access between cars
 - (d) Accessible aisle through lounge, diner, and accessible cars.

vii). Review Process

- (1) Mockups shall be complete a minimum of 15 days prior to the first stakeholder review at each applicable design review stage.
 - (a) There shall be at least 4 rounds of soft mockup reviews.
 - (b) There shall be at least 4 rounds of hard mockup reviews.
- (2) Each mockup review phase will span several weeks with up to 300+ external stakeholders reviewing and providing feedback to the current state of the designs.
- (3) Amtrak expects to make various visits to view the mock-ups throughout the design review process.
 - (a) Visits are expected to include stakeholders from both inside and outside the Amtrak organization.
 - (b) Visits are expected to include Amtrak and its consultants, FRA (Office of Civil Rights), and members of the Disability Community

viii). Approval

- (1) Approval of the mock-ups shall occur when the design elements demonstrated in the mock-ups have been frozen.

- (2) Amtrak will continue to visit and reference the mock-ups until the FAI of the first trainset or the FAI of each different car type is completed, whichever is later.
- ix). Disposal of Completed Mock-ups
 - (1) The Contractor is responsible for disposing of the mockups when the mockup deliverable is approved and closed by Amtrak.
 - (2) Contractor must request and receive permission from Amtrak prior to disposing of completed Mock-ups, as Amtrak retains the right to keep portions of, or the whole mockups as they see fit.
- c). Soft Mock-Ups **[CDRL 3-56] [CDRL 3-81]**
 - i). Purpose
 - (1) The purpose of the soft mock-ups is to evaluate special layouts and designs, and to identify potential problem areas and facilitate the development of alternative solutions.
 - ii). Materials and Finishes
 - (1) Soft mock-ups are not expected to be manufactured using final proposed materials.
 - (2) Soft Mock-ups can be built from MDF/Plywood, foam core, machined foam board, comfort foam.
 - (3) Seat and bed surfaces should have a covering of soft foam.
 - (4) Interior elements should be painted white and gray
 - (5) Power port, light switches, master control screen and all other user interfaces can be represented as labels but should be accurately placed for review by Amtrak.
 - (6) Soft Mock-ups for each accommodation room type shall be constructed of materials with sufficient strength so that ergonomics, human factors and accessibility of beds, bunks can be evaluated safely and thoroughly by Amtrak.
 - (a) Options for size shape and position of steps and handholds should be allowed for during a review process.
 - iii). Seating Areas
 - (1) Soft mock-ups of seating areas shall include accurate representations of seats in both reclined and upright positions, tables, cup holders and seat trays to assess spacing and relative positions.

- (2) Representation of typical coach and premium coach sections should be shown – with representation of, side wall, ceiling, luggage rack, window sizes and window mask treatments and seat reservation display. This should be at least 1 window module in length.
 - (3) Accurate aisle width should be represented with seating installed or configured so this can be tested.
- iv). Rooms
- (1) An individual module for each room type shall be provided, including representative exterior side wall, module walls, ceilings, and room doors to accurately represent the interior volumes.
 - (2) Seated and sleeping conditions can be supplied as separate mock-ups or plug and play adaptations (assuming this can easily and quickly be changed during a design review) for all key room types.
- v). Mechanical Features
- (1) Separate mechanical rigs will be required to demonstrate and prove out key mechanical features sets, which shall include at a minimum:
 - (a) Seat to bed conversions
 - (b) Bunk deployment
 - (c) Divider
- vi). Storage Areas and Components
- (1) A preliminary functional example of an overhead luggage rack shall be provided mounted at the design height and including the adjacent ceiling panel, built so that the loading and removal of baggage may be performed.
 - (2) A mock-up of the luggage tower should be shown in respect of its condition against a sidewall, bulkhead and aisle built so that the loading and removal of baggage may be performed.
 - (3) Stowage pockets, luggage shelves and luggage area should be dimensionally accurate and suitable construction to test storage of luggage, bottles etc.
- vii). Lighting
- (1) Lighting should be represented in the correct positions and controlled by the grouping as specified in the technical specification.
- viii). Bedroom Seat Comfort Mock-Up

- (1) A standalone seat comfort mock-up shall be provided for Amtrak review.
 - (2) The bedroom seat comfort mock-up shall prove out seat comfort and ergonomics for all bedroom seats.
 - (3) The bedroom seat comfort mock-up must accurately represent seat dimensions, cushion density and cushion profiles.
- ix). Food Service
- (1) All food service soft mockups (Kitchen, Café, Bar and Servery) should be designed in modular format with key equipment as separate representative blocks.
 - (2) The equipment positions will need evaluation and will be subject to user testing.
- x). Crew Bedrooms
- (1) Soft mockups of crew bedrooms should be built in a modular way to test different configuration of storage solutions for crew members.
- xi). Vestibule
- (1) The vestibule Soft Mockup shall show the general arrangement of the entrance area for an accessible car with elevator arrangement.
 - (2) The elevator should show how doors will work and stairs should be represented up to 8 steps high with associated handrails doors and accessible pathways.
- xii). Restrooms and Shower Rooms
- (1) Communal restrooms, shower rooms and accessible restrooms can be supplied as isolated mockups; however, they must provide an accurate representation of interior volumes, handholds, and suitable strength to test toilet seats etc.
- d). Hard-Mockups **[CDRL 3-83] [CDRL 3-86]**
- i). Purpose
 - (1) Hard mock-ups shall be used to help Amtrak finalize material, color and finish.
 - (2) Comments from the mockup reviews shall be incorporated into the design and presented to Amtrak for review and approval.
 - ii). Materials and Finishes

- (1) Hard mock-ups should be finished with final materials and finishes where possible.
 - (a) Some materials can be represented with indicative materials and finishes with the approval of Amtrak.
- (2) The hard mock-ups shall include all finishes, colors, patterns, textures, fasteners and hardware represented in the Contractor's proposal design.
 - (a) All materials utilized should be the final material choice unless otherwise approved by Amtrak.
- (3) All mockups shall be constructed of materials with sufficient strength so that they can be evaluated safely and thoroughly by Amtrak.
 - (a) This includes the ability to sit on seats, lean on countertops, open and close doors, simulate operation of controls, appliances and equipment; and view the mockup from a variety of angles.
- (4) The final mock-ups shall include all finishes, colors, patterns, textures, fasteners and hardware represented in the Contractor's proposal design.
- (5) All materials utilized should be the final material choice unless otherwise approved by Amtrak.
- (6) Approved decals and signage must be included.
- (7) Except as otherwise indicated, all equipment shall be functional; but not required to meet the performance requirements.
 - (a) When powered, all indicators, lights, doors, fans etc., shall operate.
 - (b) Electronic equipment shall be wired to permit function (e.g., indicators illuminating or fans running) when powered by an external power supply.
 - (c) Passenger Displays shall be functional.
 - (d) Lighting shall be identical to what is installed in each car type.
- iii). Food service areas shall include all equipment and countertops.
- iv). Equipment, electrical lockers and equipment lockers
 - (1) All on-board and undercar lockers shall be mocked up with all switches, breakers, relay panels, access panels, doors, controls, indicators and components simulated to evaluate access, visibility, maintainability and removal.

- (2) All equipment shall be accurately represented to allow for the evaluation of maintainability.
- e). Required Elements of Mockup Deliverables
- i). Each mock-up shall include, at a minimum, the following elements as applicable for the respective car type:
 - (1) At least four rows of seats
 - (2) Workstation table between the facing seats
 - (3) Dining Tables and seats
 - (4) Accessible Toilet Room
 - (a) A fully equipped Accessible Toilet Room (ATR) shall be included for the purpose of evaluating and confirming that the design arrangement of the ATR meets all ADA/ADAAG requirements for layout, circulation and access to controls and appliances.
 - (5) Overhead luggage racks, including reading lights
 - (a) A fully functional example of an overhead luggage rack shall be provided mounted at the design height and including the adjacent ceiling panel, built so that the loading and removal of baggage may be performed.
 - (6) Wall panels, window, window mask and shades
 - (7) Partitions and windscreens (if applicable)
 - (8) Convenience outlets with USB ports
 - (9) Heater grilles and diffusers
 - (10) Working passenger side doors
 - (11) End door, Gangways and Car-to-Car Connection
 - (a) The end door and car-to-car connection shall be complete, operable, accurate in all mechanical details, and representative of all the actual components between two of the mock-ups.
 - (12) Operational wheeled mobility device lift unit and installation shall be built to verify the function of the design.
 - (13) All Corridors, end doors, and partition doors
 - (14) Staircases, steps, handrails (where applicable)
 - (15) Elevator

- (a) Operational elevator and installation shall be built to verify the function of the design and integration into the car.
- (16) Bike Rack/Luggage Shelf Area
- (17) Interior doors
- (18) Ceiling panels
- (19) Floor panels
- (20) All lighting
 - (a) Lighting shall be identical to what is installed in each car type.
- (21) Approved decals, placards and signage
- (22) Crew consoles
- (23) Working passenger displays
- (24) Coffee station, crew cupboards
- (25) Equipment, electrical and equipment lockers:
 - (a) All on-board lockers shall be mocked up with all switches, breakers, relay panels, access panels, doors, controls, indicators and components simulated to evaluate access, visibility, maintainability and removal.
 - (b) All equipment shall be installed to all for the evaluation of maintainability.
- (26) Vestibule and side doors, wall and ceiling panel area for access to door equipment:
 - (a) Vestibule with working passenger side doors, wall and ceiling panel area for access to door equipment.
 - (b) The vestibule side doors, ceiling and wall area shall be included to simulate access to all side door equipment that requires inspection, adjustment or maintenance.
 - (c) All wall and ceiling panels shall correctly simulate the means of attachment, removal and operation, to ensure that the ceiling panels are safe and easy to use by maintenance personnel.
 - (d) High level and low-level station platform boarding areas shall be included.
- (27) All safety and emergency equipment.

- (28) Exterior
 - (a) The mock-up exterior shall be complete with respect to details and shall show the location and arrangement of all devices including, but not limited to, car ends, decals, paint finish, lights, indicators, crew steps, and handles.
 - (b) Exterior Livery should be applied to the exterior of the train
- (29) Each different Sleeper Module
- (30) Each accessible Sleeper Module
- (31) Roomette module
- (32) A pair of SoloSuite modules
- ii). The Dining Car shall also include, at a minimum:
 - (1) All Kitchen and Kitchen equipment
 - (2) 4 rows of Dining Tables and seats
 - (3) Staircase
 - (4) Dumb waiter and Cart Lift
 - (5) Servery and Servery Equipment
 - (6) Crew storage areas, emergency storage
 - (7) Accessible spaces with accessible table
 - (8) Countertops
- iii). The Utility Car shall also include:
 - (1) Bike Rack/Luggage Shelf Area, bag storage, gun lockers
 - (2) Crew bedroom
 - (3) Crew rest area, kitchenette
- iv). The Lounge Car shall also include, at a minimum:
 - (1) Bar area
 - (2) All food service equipment
 - (3) 1 module of lounge seating
 - (4) Accessible lounge seating area

- v). The Café Car shall also include, at a minimum:
 - (1) Café area
 - (2) All food service equipment
 - (3) 1 module of café seating
 - (4) Accessible café table area

3.18 Virtual Mock-Up

- a). The Contractor shall utilize an electronic virtual mockup from the conceptual stages of the project through FDR.
- b). The virtual mock-ups shall be delivered as fully 3 dimensional virtual environments running in real-time on stand-alone 6DOF (6 Degree of Freedom) headsets.
 - i). The headsets will fully track head movements allowing the user to explore the environments fully and naturally.
 - ii). The virtual mock-up platform should be designed to be collaborative, supporting up to the simultaneous participation of up to ten (10) users.
 - iii). The design data shall be optimized to run on the proposed platform.
- c). 3D modeling and VR shall be used to expedite the presentation, review and approval of concepts.
- d). The virtual mock-up shall be a real time tool to evaluate design decision and alternatives analysis through the design review process and shall be presented prior to and in parallel with the required physical mockups.
- e). Virtual mock-ups shall also be used to evaluate equipment placement and potential maintainability issues not specifically associated with the Industrial Product Design.
- f). The virtual mock-ups shall clearly and accurately show the car arrangement of each different car type including seating conditions (reclined and upright), doors, sidewalls, ceilings, lighting, partitions, accommodations, branding, equipment,
- g). The virtual mock-ups shall include all sleeper car corridors and gangways for each different sleeper car type, presenting full car length corridors including all junctions with partitions, doors and thresholds with vestibules and staircases etc. Coffee stations and crew cupboards and equipment cupboards should be shown.
- h). Color, finish and signage shall be accurately represented to the greatest extent possible.
- i). The virtual mockup shall also provide a means for evaluating maintainability as the car design progresses.

- j). The virtual mockup shall be presented during IDR and FDR for all systems to ensure no interferences are present.
- k). The virtual mockups shall be an integral element of each design review phase.
- l). Approval of the virtual mockups shall be required as part of the completion of each design review phase prior to progressing to the next design phase:
 - i). PDR **[CDRL 3-59]**
 - ii). IDR **[CDRL 3-79]**
 - iii). FDR **[CDRL 3-84]**
- m). The virtual mockups shall present the industrial product design and shall include the up-to-date CMF application and the representation of accurate lighting.
- n). During the Industrial Product Design PDR and IDR Phases:
 - i). The Contractor shall conduct a review of the virtual mock-ups of all room types and all interior spaces.
 - ii). The virtual mock-ups shall include the vestibule area and complete staircase, with the functionality to virtually move up the staircase.
 - iii). The virtual mock-ups shall be reviewed and accepted by Amtrak before commencement of physical mock-ups.
- o). During the Industrial Product Design FDR Phase, the Contractor shall present to Amtrak for review and approval the final version of the virtual mock-ups of all cars modeled as fully textured CMF representation.

3.19 Renderings

- a). General
 - i). The Contractor shall submit renderings to facilitate the interior and exterior design efforts.
 - ii). The renderings should be delivered to a high production value and present the design to a photorealistic level, including accurate representation of color, materials, textures, and finishes, lighting and reflections.
 - iii). The renderings shall convey the design, appearance and functional intent of the proposed product.
 - iv). The renderings shall show the proposed position, size and appearance of equipment, components, furniture, and appliances in each space.
 - v). The first set of renderings shall be submitted 30 calendar days prior to the first Interior PDR. **[CDRL 3-57]**

- vi). Revised renderings shall be revised and submitted as the design changes through IDR [CDRL 3-77] and FDR [CDRL 3-87] until the interior and exterior design is frozen.
- vii). Format
 - (1) Renderings shall be provided electronically in both TIFF and JPEG formats with a minimum of 1920 x 1080 resolution.
 - (2) Additionally, each submittal package of renderings shall include full color print versions at a minimum of 11' x 17', printed on glossy paper.
 - (3) Amtrak accepted final renderings shall be provided in high resolution electronic format as well as 24 (twenty-four) sets of high-quality D size (24 inches x 35 inches) poster board backed prints for display in public forums.
- b). Interior Renderings
 - i). Interior renderings shall be provided to convey the options for interior layouts
 - ii). Renderings shall be submitted for each product type, car class/variant.
 - iii). Renderings shall be fully detailed and shall present all amenities and features included onboard the cars.
 - iv). Renderings should accurately represent all the color materials and finishes.
 - (1) These should be supported by the Color Material and Finish (CMF) sample boards at each stage.
 - v). Renderings should accurately show the lighting conditions as well as different lighting states (daytime mode and evening mode).
 - (1) Renderings shall show how different groupings of lights and how different lighting levels and colors can change the ambiance and mood of the space.
 - vi). Renderings should show the various states possible for equipment and accommodations, such as seating upright and reclined and bedrooms arranged for both seating and sleeping.
 - vii). Renderings included in the Industrial Product Design PDR package shall include:
 - (1) Renderings of each proposed seating design concept.
 - (a) Renderings shall include front, back, side and three-quarter images.

- (b) Renderings shall present the full feature set of each proposed concept, as well as the equipment in all seating conditions (reclined upright, table out etc.).
 - (c) Rendering shall include annotated break out of key features and shall identify key and critical dimensions.
 - (2) Interior renderings showing all accessible spaces in each car type.
 - (a) All accessible coach spaces
 - (b) All rooms (including crew bedrooms and quarters) showing and accurate representation of Color Material and Finish (CMF).
 - (i) Rendering submittals shall include at least 4 hero shot renders of each room type.
 - (c) Schematic 3D screen shots/renders showing room module elements and break out of parts and annotated to break out of key features and identify key and critical dimensions.
 - (d) All vestibules, corridors, coffee stations (both central and side) and staircases
 - (e) Lounge, Bar, Coach Café and Servery
 - (f) All restrooms
 - viii). Renderings included in the Industrial Product Design IDR package shall include:
 - (1) Revised full renderings as called out in section 3.17.c for all spaces presenting how the design is evolving and clearly identifying any changes or revisions since the PDR submittal.
 - (2) Renderings shall incorporate the application of the current Color Material and Finish as well as all states and lighting conditions
 - ix). Renderings included in the Industrial Product Design FDR package shall include:
 - (1) Final and full suite of all spaces as final renderings for sign off on design. Minimum of 6 renders of each space
 - (2) Final full and comprehensive Schematic renders – showing all features sets and key dimensions
 - (3) Creation of final design book combining renders, drawings, layouts and schedule of finish.
- c). Exterior Renderings

- i). Throughout the Industrial Product Design Review process, the Contractor shall submit to Amtrak for review and approval exterior renderings of each car type and variant.
 - (1) Renderings shall show the complete cars, fully equipped and in a ready for service condition, including end masks, doors, windows, and all exterior features.
 - (2) The Renderings shall include proposed livery color scheme, finish and use of decals (reflective and non-reflective).
 - (3) To facilitate the review of reflective decals, the Renderings shall include night-time view of front, side and three quarter profile view.
- ii). A minimum, six (6) sets of renderings (each with all the necessary views) shall be submitted for Amtrak review and approval as the design evolves over the Design Review Process.
 - (1) Each successive set of renderings will show refined levels of detail and communicate how the contractor will deliver the exterior livery design ambitions set out by Amtrak design vision.
- iii). Livery design shall be supported by 2D elevation artworks for all car types – supplied as .PDF and .AI and shall include each car type as well as a complete trainset.
- iv). Final artworks should be supplied as color correct artworks with application guidelines. **[CDRL 3-85]**.

3.20 Color Material and Finish (CMF)

- a). A robust process will need to be developed by the Contractor to deliver the ambition as set out by Amtrak's design vision with a CMF scheme that represents its brand and unique long distance brand DNA.
- b). As part of the process, the Contractor shall provide:
 - i). Evolving sets of materials boards and samples are required at each stage of the design review process. **[CDRL 3-58] [CDRL 3-82] [CDRL 3-88]**
 - ii). Samples boards should be produced that include all interior materials and finishes for the Coach environments and room products.
 - (1) Sample boards shall be delivered as a collection of all materials that represent all the materials in each area.
 - (2) Individual samples will not be reviewed or approved without the context of the other materials in the palette for that space.

- (3) Samples will not be approved without an accompanying 3D render of the space showing an accurate representation of the color, material, and finish.
- iii). Material suppliers and detailed material specifications and data sheets are required for review by Amtrak for each material. **[CDRL 3-92]**
- iv). Large samples for flooring and seating should be delivered to coincide with Soft-mock up review.
- v). Duplicate sample boards should be produced. (3 sets per space)
- vi). The Contractor shall support up to three rounds of sampling as materials are color matched, or materials refined.
 - (1) Material supplier briefs must be submitted to Amtrak for review and approval to ensure that they meet Amtrak's needs and expectations.
 - (2) Specific refinement will be expected for seating and flooring with rounds of color matching by suppliers expected up to five rounds.
- vii). A Schedule of Finish documentation which shall identify the CMF for every part of the interior. **[CDRL 3-93]**

3.21 Requirements for Drawings, Documents and Data

- a). Individual drawings shall be prepared for each part incorporated, designed and/or manufactured by or for the Contractor for the construction of the cars.
- b). Any and all drawings, shop drawings, plans and specifications produced by the Contractor shall upon presentation to Amtrak, become the property of Amtrak consistent with the General Provisions.
- c). Assembly, sub-assembly and arrangement drawings shall include a complete Bill of Materials on the field of the drawing or as a subsequent sheet.
 - i). The Bill of Materials shall describe all items, including the subcontractor's parts and all equipment and details which form part of the assembly.
- d). American Welding Society (AWS) standards, references and symbols shall be used at weldments in drawings.
- e). All the drawings supplied by the Contractor in accordance with this Specification shall be so delineated that the wiring, piping, or mechanical interference between components shall be readily and clearly identifiable.
- f). The Contractor's Safety Engineer shall review all design layouts, assembly, and subassembly drawings of safety related features prior to their submission to Amtrak and/or their release for production to ensure the safety of operations personnel, maintenance personnel and the riding public.

- g). Drawing Sizes and Requirements
 - i). All drawings shall be prepared in American National Standards Institute (ANSI) standard sizes.
 - ii). All Contractor drawings shall utilize a standard title block in the lower right corner and application block in the upper-right hand corner
 - (1) The arrangement for the title block and the application block shall be agreed upon prior to the start of PDR.
 - iii). The Contractor shall be responsible for the conformity and standardization of all sub-suppliers drawings to be submitted to the Amtrak.
- h). Bills of Material
 - i). All drawings shall include Bills of Material with a numbering system for easy identification on the drawing.
 - ii). Bills of Material shall indicate piece part and assembly weights.
 - iii). Bills of Material shall include US equivalent units.
 - iv). Bills of Material shall be carried on the drawings, or on attached sheets of the same size.
 - v). Bills of Material descriptions shall positively identify the materials used.
 - vi). For items on the Bills of Material referring to common manufactured materials, the description shall contain the manufacturer name, and manufacturer's part numbers for the material.
 - vii). The Bill of Material shall have a separate column for future insertion of Amtrak's part numbers.
- i). Dimensions
 - i). All dimensions shall be shown in both imperial and metric units.
 - (1) Metric dimensions, enclosed in parentheses, shall follow imperial dimensions.
 - ii). Imperial units shall be shown consistently on all drawings as follows:
 - (1) Inches and fractions, or inches and decimals throughout.
 - (2) One inch mark (") shall be shown to the right of each dimension.
 - (3) Decimals shall be shown with maximum of three significant figures to the right of the decimal point as required.
 - iii). Dimensions up to and including 72" shall be shown in inches.

- iv). Dimensions above 72" shall be shown in feet and inches.
- j). Metric units shall be shown consistently on all drawings as follows:
 - i). Metric units shall be shown as millimeters and decimals.
 - ii). Millimeter units shall be accompanied by one blank space and the letters "mm" to the right of the figures.
 - iii). Dimensions smaller than one meter shall be shown in millimeters.
 - iv). Dimensions one meter and larger shall be shown in meters and decimal meters (1.000 m)
 - v). Decimal units shall be shown with as many significant figures to the right of the decimal point as required.
- k). Stationing
 - i). Numerical station dimensions and lines shall be used on all assembly drawings, and as frequently as possible on detail drawings and views, to locate the individual items in the overall car configuration. All assembly and sub-assembly drawings shall contain station information to accurately locate the item on the car.
 - ii). Stations shall be shown in three planes:
 - (1) Longitudinally, commencing with the pulling face of coupler (P.F.C.) at the front end of the car.
 - (2) Transversely, commencing with the longitudinal centerline of the car and increasing left and right.
 - (3) Vertically, commencing with the tops of the running rails.
 - (4) Station figures shall be enclosed in circles.
 - (5) Transverse dimensions shall have the letters "L" or "R" shown below the figures, to indicate "left" and "right".
 - (6) Vertical dimensions shall have the letters "ATOR" (above top of rail) shown below the figures.
- l). Numbering
 - i). The Contractor shall confer with Amtrak to develop a numbering system compatible with both the Contractor and Amtrak's standard numbering systems.
 - ii). All revisions of drawings shall be identified with an alphabetic suffix.

m). Integrated Schematic Package

i). General

- (1) The Integrated Schematic Package shall be submitted as a component of the Running Maintenance Manuals.
- (2) The Integrated Schematic Package shall be comprised of two parts:
 - (a) Integrated Schematics
 - (b) Integrated Wiring Diagrams
- (3) The Integrated Schematics shall include all electronic and electrical components on the car.
 - (a) All minor subsystem components housed in "black boxes" shall also be included in the Record Drawings Schematic Package.
 - (b) The Integrated Schematic shall provide the physical location of all electrical system components.

ii). Electrical Schematics

- (1) The Contractor shall prepare and submit, for approval by Amtrak, an integrated schematic diagram package relating all electrical systems and including all components and all wiring on the cars.
- (2) The schematic diagram shall be one which can be readily followed by technicians with basic electrical knowledge.
- (3) Both an alphabetic tabulation and pictorial locator of all electrical components and devices and the physical location of these components shall be included with the integrated schematics.
 - (a) This tabulation should also identify the circuits where components are used, and the location of each circuit in the schematic package.
 - (b) Each drawing within the schematics shall include a grid locating system which shall be referenced for continuation to other drawings.
 - (c) Wire List
 - (i) The schematics shall be accompanied by a complete Wire List. The list shall include for each wire, as a minimum:
 1. Originating equipment
 2. Destination equipment

3. Wire size and type
 4. Conduits and Raceways through which the wire runs
 5. Wire number
- (ii) This Wire List shall be provided in an electronic database format (with database software and license provided).
1. The database shall be arranged in logical fields that will allow various sorts of the information (such as by equipment, wire number, conduit, etc.).
 2. Both hardcopy and electronic media file shall be provided.
- iii). Pneumatic Schematics
- (1) In addition to electrical schematics, the integrated schematic package shall contain pneumatic schematics including, at a minimum:
 - (a) Compressed Air System
 - (b) Brake System
 - (c) Secondary Suspension
 - (d) Any other pneumatic components or systems.
- iv). Wiring Diagrams
- (1) Complete wiring diagrams shall also be provided for all car wiring.
 - (2) These diagrams shall be arranged logically and all text shall be clearly legible.
 - (3) Wiring Diagrams shall:
 - (a) Identify all conduits and raceways in which wires are run
 - (b) Identify all wires in each conduit/raceway
 - (c) Clearly denote all connections at terminal blocks and connectors.
 - (4) A separate drawing noting the physical locations of all terminal boards and junction boxes shall be provided as part of the wiring diagram package
- v). Format

- (1) Samples formats for the following shall be submitted to Amtrak for review and approval before submittal as a component of the maintenance manuals:
 - (a) Electrical Schematics **[CDRL 3-94]**
 - (b) Pneumatic Schematics **[CDRL 3-95]**
 - (c) Electrical Component/Device Table **[CDRL 3-96]**
 - (d) Wiring Diagram **[CDRL 3-97]**
 - (e) Wire Run List **[CDRL 3-98]**
 - (2) The schematics shall be provided in B size, 11 inch by 17 inch packages.
 - (3) All schematics shall be prepared so that all text and other items on the drawings are clearly legible on the 11 inch by 17 inch sheets.
- n). All other document control and formatting requirements shall be discussed and agreed upon within 30 days after the project kick-off meeting.

3.22 Rapid Prototype Cars

- a). In previous contracts, Amtrak has allowed Contractors to progress with the development of rapid prototype cars (RPC) in parallel with the Design Review process.
- b). The advantage of this process was to help prove out manufacturability issues, confirm system integration and conduct pre-qualification testing prior to the construction of the deliverable pilot trainset.
- c). Should the Contractor desire to propose the incorporation of rapid prototype cars, it should develop and submit to Amtrak a proposal for review and approval detailing the following:
 - i). A detailed schedule showing the progression of the RPC in parallel with the Formal Design Review Process.
 - ii). Detail of the implementation of gateways in the Design Review Process which will limit and control the progression of the RPC process.
 - iii). A discussion of how the RPC process will be used to support and optimize the Design Review Process.
 - iv). Should the Contractor desire to utilize an RPC as a production car, a plan on how it would be remanufactured to comply with the following:
 - (1) Completion of all FMIs

- (2) Replacement of any pre-FAI components with post FAI equipment
 - (3) Agreement with final design configuration
 - (4) All quality requirements of this specification, including formal re-inspection of the updated vehicle by Amtrak resident inspectors
 - (5) Final and complete vehicle testing
- d). The following shall be considered constraints for the development of a Rapid Prototype Car process:
- i). Process shall not be started until after the carshell design and testing has been completed. The carshell shall be manufactured to the final configuration and using the production process.
 - ii). The RPCs shall not be considered the pilot cars and shall not be the first cars to be delivered to Amtrak.
 - iii). The incorporation of an RPC process shall not negatively impact the contractual schedule.
 - iv). The incorporation of an RPC process shall not result in an increased contract cost to Amtrak.
 - v). The incorporation of an RPC process shall not negatively impact the material supply for the pilot or production cars.
 - vi). The complete vehicle FAI shall not be performed on the RPCs.
- e). The decision to allow the incorporation of an RPC program shall be solely at Amtrak's discretion.

3.23 CDRLs

CDRL 3-01	Project Management Plan (PMP)	NTP + 30 days
CDRL 3-02	System Integration Plan (SIP)	30 days prior to 1 st PDR meeting
CDRL 3-03	Interface Control Document (ICD)	30 days prior to 1 st PDR meeting
CDRL 3-04	Kick-off Meeting Presentation	At least 5 days before kick-off meeting and within 10 days of NTP
CDRL 3-05	Baseline Master Project Schedule (Baseline MPS) and Narrative	NTP + 30 days
CDRL 3-06	Design Review Plan	NTP + 30 days
CDRL 3-07	Detailed Drawing Tree	30 days prior to start of 1 st Preliminary Design Review

CDRL 3-08	Compliance Matrix	Contract Award and 30 days prior to each design review
CDRL 3-09	Trainset Preliminary Design Review (PDR)	90 days after Contract Award
CDRL 3-10	PDR – Compliance Matrix	30 days prior to 1 st PDR meeting
CDRL 3-11	PDR – Drawing Tree and Schedule	30 days prior to 1 st PDR meeting
CDRL 3-12	PDR – System Functional Description	30 days prior to 1 st PDR meeting
CDRL 3-13	PDR – Arrangement Drawings and Related Documents	30 days prior to 1 st PDR meeting
CDRL 3-14	PDR – Detailed Technical Specification	30 days prior to 1 st PDR meeting
CDRL 3-15	PDR – Detailed Technical Specification covering methods, materials and arrangements for pilot car construction.	30 days prior to 1 st PDR meeting
CDRL 3-16	PDR – Table of suppliers and products	30 days prior to 1 st PDR meeting
CDRL 3-17	PDR – Weight Analysis	30 days prior to 1 st PDR meeting
CDRL 3-18	Intermediate Design Review (IDR)	60 days after the closure of PDR
CDRL 3-19	IDR – All Drawings in the Drawing Tree	30 days prior to IDR meeting
CDRL 3-20	IDR – Drawing Tree: 2 Additional Levels	30 days prior to IDR meeting
CDRL 3-21	IDR – Draft Single Line Control Schematic	30 days prior to IDR meeting
CDRL 3-22	IDR – Functional Block Diagrams	30 days prior to IDR meeting
CDRL 3-23	IDR – Electrical Wiring Diagrams & Schematics	30 days prior to IDR meeting
CDRL 3-24	IDR – Clearance Drawings	30 days prior to IDR meeting
CDRL 3-25	IDR – Piping Diagrams	30 days prior to IDR meeting
CDRL 3-26	IDR – Manufacturer’s Data and Spec Sheets for all Control items	30 days prior to IDR meeting
CDRL 3-27	IDR – Updated Compliance Matrix	30 days prior to IDR meeting

CDRL 3-28	IDR – Updated Interior Renderings	30 days prior to IDR meeting
CDRL 3-29	IDR – Updated Exterior Renderings	30 days prior to IDR meeting
CDRL 3-30	IDR – CMF Palette	30 days prior to IDR meeting
CDRL 3-31	IDR – Interior Material Samples	30 days prior to IDR meeting
CDRL 3-32	IDR – Layout of Product Accommodations	30 days prior to IDR meeting
CDRL 3-33	IDR – Draft Maintenance Requirements and Procedures	30 days prior to IDR meeting
CDRL 3-34	Final Design Review (FDR)	90 days after the close of IDR
CDRL 3-35	FDR – Weight Analysis	30 days prior to FDR meeting
CDRL 3-36	FDR – Detailed Technical Specification	30 days prior to FDR meeting
CDRL 3-37	FDR – Functional Analysis	30 days prior to FDR meeting
CDRL 3-38	FDR – Drawing Schedule	30 days prior to FDR meeting
CDRL 3-39	FDR – Arrangement Drawings	30 days prior to FDR meeting
CDRL 3-40	FDR – Supplier Identification	30 days prior to FDR meeting
CDRL 3-41	FDR – All Drawings in the Drawing Tree	30 days prior to FDR meeting
CDRL 3-42	FDR – Single Line Control Schematic	30 days prior to FDR meeting
CDRL 3-43	FDR – Functional Block Diagrams	30 days prior to FDR meeting
CDRL 3-44	FDR – Electrical Wiring Diagrams & Schematics	30 days prior to FDR meeting
CDRL 3-45	FDR – Clearance Drawings	30 days prior to FDR meeting
CDRL 3-46	FDR – Piping Diagrams	30 days prior to FDR meeting
CDRL 3-47	FDR – Graphs and Curves of Response and Functional Characteristics	30 days prior to FDR meeting
CDRL 3-48	FDR – Manufacturer's Data and Spec Sheets for all Control items	30 days prior to FDR meeting
CDRL 3-49	FDR – Maintenance Requirements and Procedures	30 days prior to FDR meeting

CONFIDENTIAL — DO NOT DISTRIBUTE

CDRL 3-50	FDR – Finite Element Stress Analysis	30 days prior to FDR meeting
CDRL 3-51	FDR – Final Interior Renderings	30 days prior to FDR meeting
CDRL 3-52	FDR – Final Exterior Renderings	30 days prior to FDR meeting
CDRL 3-53	FDR – CMF Boards & Samples	30 days prior to FDR meeting
CDRL 3-54	FDR – Industrial Product Design Book	30 days prior to FDR meeting
CDRL 3-55	All documentation required by 49 CFR 238.110 as listed in the NPRM.	30 days prior to IDR
CDRL 3-56	IPD PDR – 1 st Round of Soft Mockups	15 days prior to the first stakeholder review
CDRL 3-57	IPD PDR – 1 st Round Rendering	30 days prior to PDR
CDRL 3-58	IPD PDR – Initial Color Material and Finish (CMF) Boards	30 days prior to PDR
CDRL 3-59	IPD PDR – Clay Model VR	30 days prior to PDR
CDRL 3-60	IPD PDR – 2D Layouts	30 days prior to PDR
CDRL 3-61	IPD PDR – At least 3 exterior livery designs	30 days prior to PDR
CDRL 3-62	IPD PDR – 3 different seating products from preferred supplier for Coach and Premium Coach seating	30 days prior to PDR
CDRL 3-63	IPD PDR – 2 alternative seating suppliers and their products	30 days prior to PDR
CDRL 3-64	IPD PDR – 3 Detailed concepts for Coach and Premium Coach seating types	30 days prior to PDR
CDRL 3-65	IPD PDR – Human factors study for seating	30 days prior to PDR
CDRL 3-66	IPD PDR – Elevation and top-down layouts	30 days prior to PDR
CDRL 3-67	IPD PDR – Accessibility Proposal	30 days prior to PDR
CDRL 3-68	IPD PDR – 3 Concepts for Bedroom Seating	30 days prior to PDR
CDRL 3-69	IPD PDR – Bedroom Seating soft mock-up for comfort validation	30 days prior to PDR
CDRL 3-70	IPD PDR – Sleeper Car Concepts	30 days prior to PDR
CDRL 3-71	IPD PDR – Accessible Bedroom and Restroom Design Validation	30 days prior to PDR

CDRL 3-72	IPD PDR – Accessible Restroom User Testing	30 days prior to PDR
CDRL 3-73	IPD PDR – 3 Concepts for Accessible Premium Bedroom Layouts	30 days prior to PDR
CDRL 3-74	IPD PDR – 3 Concepts for Crew Bedroom and Storage	30 days prior to PDR
CDRL 3-75	IPD PDR – Crew Bedroom and Storage testing with User Groups	30 days prior to PDR
CDRL 3-76	IPD PDR – Detailed presentation of all food service area areas	30 days prior to PDR
CDRL 3-77	IPD IDR – Updated Renderings	30 days prior to IDR
CDRL 3-78	IPD IDR – Updated 2D Drawings	30 days prior to IDR
CDRL 3-79	IPD IDR – Updated VR Environments	30 days prior to IDR
CDRL 3-80	IPD IDR – Updated Livery Artworks	30 days prior to IDR
CDRL 3-81	IPD IDR – Updated Soft Mock-ups	15 days prior to the first stakeholder review
CDRL 3-82	IPD IDR – Sampling and Color Boards	30 days prior to IDR
CDRL 3-83	IPD IDR – 1 st Round Hard Mock-Ups	15 days prior to the first stakeholder review
CDRL 3-84	IPD FDR – VR Environments	30 days prior to FDR
CDRL 3-85	IPD FDR – Livery Artworks	30 days prior to FDR
CDRL 3-86	IPD FDR – Hard Mock-ups	15 days prior to the first stakeholder review
CDRL 3-87	IPD FDR – Renderings	30 days prior to FDR
CDRL 3-88	IPD FDR – Color Material and Finish Boards	30 days prior to FDR
CDRL 3-89	IPD FDR – Final Design Book	30 days prior to FDR
CDRL 3-90	IPD FDR – All Approved Physical Material Samples	30 days prior to FDR
CDRL 3-91	Mockup and Rendering Review Plan	NTP + 30 days
CDRL 3-92	Material Suppliers and detailed Material Specifications and Data Sheets	30 days prior to each Design Review
CDRL 3-93	Interior Schedule of Finish documentation	30 days prior to each Design Review
CDRL 3-94	Draft Formats – Electrical Schematics	30 days prior to IDR
CDRL 3-95	Draft Formats – Pneumatic Schematics	30 days prior to IDR
CDRL 3-96	Draft Formats – Electrical Component / Device Table	30 days prior to IDR
CDRL 3-97	Draft Formats – Wiring Diagram	30 days prior to IDR
CDRL 3-98	Draft Formats – Wire Run List	30 days prior to IDR

* End of Chapter 3 *

Amtrak Long Distance Bi-Level Fleet Replacement

Technical Specification

4. Reliability, Availability and Maintainability

Revision 1

Table of Contents

4.1	Reliability Overview	4-1
4.2	Reliability Program Plan.....	4-2
4.3	Reliability Requirements	4-3
4.4	Failure Review Board.....	4-5
4.5	Reliability Demonstration Testing.....	4-6
4.6	Design Changes after Pilot Trainset delivery	4-10
4.7	Maintainability	4-11
4.8	CDRL List	4-18

Table of Figures

Figure 4-1:	MDBCF Requirements.....	4-4
Figure 4-2:	MTTR Requirements	4-15

4.1 Reliability Overview

- a). This chapter defines the Reliability, Availability, and Maintainability (RAM) and Warranty requirements for the Amtrak Long Distance Fleet Replacement program, including analysis and other submittal requirements.
 - i). The Contractor shall ensure that the level of reliability, availability, and maintainability provided by the cars supplied under this Contract meet or exceed the minimum requirements defined in this technical specification.
 - ii). Each design review shall include dedicated sections to address each of reliability, availability and maintainability for all systems. Each design review meeting shall include dedicated time to review these for each system.
- b). The long-distance fleets will spend much of their operating life hundreds of miles away from the nearest repair point with no onboard mechanical personnel and few if any tools and where alternative transportation for passengers in the event of a mechanical failure will be limited and time consuming to obtain if available at all.
 - i). The cars will be in mechanical facilities every second or third day.
- c). Reliability and uptime of systems is of the utmost importance on these cars.
 - i). Designs must be robust, prioritizing reliability in all mechanical, electrical, and digital aspects.
 - ii). Where possible, system design should incorporate elements that will allow partial functionality when some components have failed, or lockouts to allow the car to continue to move safely until a repair point can be reached.
- d). The Contractor shall incorporate a Design for Reliability (DfR) philosophy throughout the design process.
 - i). DfR is a process that ensures a product, or system, performs a specified function within a given environment over its expected lifetime.
 - ii). DfR requires the integration of product design and process planning into a cohesive, interactive activity known as concurrent engineering.
 - iii). The Contractor shall discuss the implementation of DfR in its Reliability Program Plan.
 - iv). By employing DfR, Contractor shall consider reliability throughout the design process to minimize the types and impact of component failures, minimize single point failures, and identify and mitigate failures of critical components that affect system operation.
 - v). DfR would be expected to include:
 - (1) Utilize mature designs for systems and components.
 - (2) Select suppliers with effective parts controls programs.

- (3) Minimize design complexity and dormant failure possibilities.
- (4) Consider parts obsolescence in the design process.
- (5) Ensure component duty cycles do not exceed limits.
- (6) Ensure heat sources are insulated from critical components.
- (7) Ensure components are isolated to minimize shock and vibration.
- (8) Use electro-magnetic interference (EMI) protection on all electronic equipment.
- (9) Use best reliability design practices.
- (10) Redundancy between components wherever practical

4.2 Reliability Program Plan

- a). The Contractor shall develop and implement a Reliability Program Plan to ensure the vehicle, its systems, and its subsystems meet or exceed the reliability requirements specified in this chapter.
- b). The Contractor shall be responsible for providing all measures required to meet the specified requirements, including design, manufacture, installation, retrofit of the entire fleet, and all changes.
- c). No later than 30 days after NTP, the Contractor shall submit a Reliability Program Plan **[CDRL 4-01]** prior to Preliminary Design Review (PDR) and it shall be updated throughout the design process.
- d). The Plan shall be submitted for Amtrak's review and approval.
- e). The Reliability Program Plan should discuss the following items:
 - i). Reliability program objectives and requirements.
 - ii). Reliability program schedule, including activities and delivery dates.
 - iii). Organization structure, including the name(s) and qualifications of the Reliability Engineer(s).
 - iv). Methodologies used for analyses to ensure Plan requirements are achieved, including criteria for Line Replaceable Unit (LRU) classification.
 - v). Process for identifying subcontractors based on history of reliability capabilities and controls for activities of subcontractors and equipment suppliers.
 - vi). Reliability allocations.
 - vii). Method for component qualification and parts selection.

- viii). Reliability demonstration test plans, including pass-fail criteria.
- ix). Failure Review Board (FRB).
- x). Reliability database or process to control failure data for FRB.
- xi). Corrective action procedures, including procedure for failure analysis, root cause identification and verifying implementation of corrective actions. This should also address Fleet Defects.
- xii). Failure Reporting and Corrective Action System (FRACAS), including documentation procedures for capturing failure data, to include factory testing.
- xiii). Reliability Progress Reporting [**CDRL 4-02**], which details implementation of the approved program.
 - (1) Reports shall be submitted to Amtrak on at least a monthly basis to provide updates on critical Reliability KPIs (MDBCF, MDBSF, Availability, Failures and Fleet Defects).

4.3 Reliability Requirements

- a). Every complete car, as well as each constituent component, assembly, subsystem and system element shall be designed in such a manner as to perform its function reliably in revenue service.
- b). Failure Rates
 - i). Each car under all system operating conditions shall operate with a failure rate not exceeding that defined in these Technical Specifications.
 - ii). The car design and implementation of the design shall provide Amtrak with equipment that meets the Mean Distance Between Service Failure (MDBSF) and Mean Distance Between Component Failure (MDBCF) requirements.
 - iii). Compliance with MDBSF requirements shall include all failure modes for systems, subsystems, and components to meet the following requirements:
 - (1) Coach MDBSF = 150,000 miles
 - (2) Roomette/Bedroom Car MDBSF = 150,000 miles
 - (3) Diner and Lounge Car MDBSF = 150,000 miles
 - (4) The reliability objectives shall be based on single car operation at an average speed of 55 mph (88.5 kph.) and a utilization of 215,000 miles/yr. (344,000 km/yr.).
- c). Passenger Comfort
 - i). A Passenger Comfort Failure shall be defined as a car-related failure resulting in decreased availability of passenger amenities that does not meet

the definition of a Service Failure, i.e., loss of control panels, lighting, HVAC, seating and sleeping capabilities.

- ii). Passenger Comfort Failures shall be captured in MDBCFC calculations.
- iii). Passenger Comfort Failures are inherent component failures which exclude consumables, vandalism, human error, incorrect maintenance, and quality issues.
- iv). Component Reliability Requirements
 - (1) The following MDBCFC requirements shall be met:

Figure 4-1: MDBCFC Requirements

System	MDBCFC
Braking System	300,000 miles [482,700 km]
Side and End Doors	300,000 miles [482,700 km]
HVAC System	380,000 miles [611,420 km]
Couplers	300,000 miles [482,700 km]
Trucks and Suspension	750,000 miles [1,207,008 km]
Auxiliary Power Systems	360,000 miles [579,363 km]
Lighting	1,000,000 miles [1,609,344 km]
Wheels and Axles	300,000 miles [482,700 km]
Communications Systems	600,000 miles [965,606 km]
Water and Waste System	750,000 miles [1,207,008 km]
Food Service (Diner and Lounge)	750,000 miles [1,207,008 km]
Roomette/Bedroom Car	600,000 miles [965,606 km]
Wheelchair Lift	300,000 miles [482,700 km]
Toilet room	750,000 miles [1,207,008 km]
Truck Monitoring Equipment	450,000 miles [724,204 km]
Elevator and Vertical Lifts	300,000 miles [482,700 km]

- d). Reliability Prediction Analysis
 - i). The Contractor shall submit a Reliability Prediction Analysis **[CDRL 4-03]** prior to PDR, and approved prior to Final Design Review (FDR), to demonstrate how the system and subsystem reliability requirements can be achieved with their design.
 - ii). The Reliability Prediction Analysis should utilize historical reliability data wherever possible and minimize the use of handbook practices such as MIL-HDBK-217F or the NPRD.
 - iii). The Reliability Prediction Analysis shall be updated throughout the design process, no less frequently than bi-monthly.
 - iv). The Reliability Prediction Analysis shall be performed to the LRU level.

- e). Availability Requirements
 - i). Car reliability and car maintenance requirements shall be such that fleet availability shall exceed 99.99%, where Availability is defined as:

$$\text{Availability} = \frac{\text{MTBF}}{\text{MTBF} + \text{MTTR}}$$

- ii). Availability shall be measured daily and the exact time at which it will be measured must be approved by Amtrak.

4.4 Failure Review Board

- a). A Failure Review Board (FRB) shall be jointly established, consisting of representatives from Amtrak and from the Contractor.
 - i). The core members of the FRB shall be the Contractor's Warranty Manager and Reliability Engineers and Amtrak's assigned Reliability Representative/Warranty Officer.
 - ii). The core members shall be supplemented by appropriate personnel from Amtrak, the Contractor, and subcontractors/suppliers, as required, to facilitate a thorough and accurate review of all the data.
 - iii). The Contractor shall ensure the participation of subcontractors/suppliers to provide subject matter expertise of any problems with components/subsystems and to expedite resolution.
- b). The FRB shall meet regularly, beginning when the first cars undergo factory acceptance testing and continuing through the Reliability Demonstration Test to the end of the Warranty Period.
 - i). FRB meetings shall be scheduled weekly with the understanding that Amtrak may, at its sole discretion, require more or less frequent meetings depending on the reliability of the equipment.
- c). Responsibilities
 - i). The FRB shall review the failure report forms and logs to verify failure classifications and assign responsibilities of failures.
 - ii). The FRB shall review all reliability test data and failure reports, review failure analyses, report progress toward meeting reliability requirements, identify areas needing improvement, and propose actions to ensure the successful completion of the reliability demonstration.
 - iii). The FRB shall correct and update failure reporting and corrective action system (FRACAS) data.
- d). In the event the FRB is unable to reach agreement on the categorization of failures (chargeable/non-chargeable) or on the corrective action to be taken for any item,

Amtrak's Reliability Representative will forward the issue, with relevant records and documentation, to Amtrak's Program Manager.

- i). The Program Manager will act as the arbitrator for all project issues.
- ii). Where appropriate, Amtrak's Program Manager will meet with the Contractor's representative to determine the path forward.
- iii). Upon agreement, the decision will be formally communicated to the Contractor and the FRB.

4.5 Reliability Demonstration Testing

a). General

- i). As a condition precedent to Final Fleet Acceptance, a Reliability Demonstration must be successfully performed, analyzed and reported upon by the Contractor to validate the reliability of the cars, systems, subsystems and components during revenue operation.
- ii). The Contractor shall closely monitor the failure modes of all systems to ensure that the cars will meet requirements.
- iii). If at any time during the Reliability Demonstration the failure rate of any system exceeds the allowable failure rate (i.e., the MDLBCF requirements listed in Figure 4-1), the Contractor shall seek modifications and changes to bring the system into compliance.
- iv). Reliability calculations will be performed using a 12-month rolling average.
 - (1) All equipment failures during car burn-in shall be reported and recorded, but not counted in establishing MDLBCF and MDLBSF values.
 - (2) Determination of pass or fail will be assessed only at the end of the reliability demonstration.

b). Grace Period

- i). During the first six (6) months of data collection, Amtrak will consider the reliability results as biased by system interface issues, workmanship issues, and infant mortality failures and will not hold the Contractor responsible for its reliability goals.
- ii). The Failure Review Board shall, however, be active during this grace period.
- iii). During the grace period, the Contractor must submit a procedure to identify the collection, review and control of the failure data pertinent to the Reliability Demonstration.

c). Reliability Progress Reporting

- i). The Contractor shall submit monthly Reliability Progress Reports **[CDRL 4-02]** following the first Failure Review Board (FRB) meeting.

- ii). The format for the monthly reports shall be determined by the FRB members, but shall include, at a minimum, the following:
 - (1) RAM activities within the reporting period, including minutes and actions of the Failure Review Board meetings.
 - (2) Reliability Test Report.
 - (3) Reliability achievements and problems.
 - (4) Reliability requirements, generic formulas and performance summaries for all defined requirements:
 - (a) Mean Distance Between Service Failures – Car Level
 - (b) Mean Distance Between Service Failures – Subsystem Level
 - (c) Mean Distance Between Component Failures – Car Level
 - (d) Mean Distance Between Component Failures – Subsystem Level
 - (e) Availability
 - (f) Fleet Defect items
 - (5) Reliability critical items.
 - (6) Expected reliability activities within the next reporting period.
 - (7) A summary and schedule of corrective actions, including in-progress and planned.
- d). Component Failures
 - i). All parts or material returned to the Contractor for repair or replacement shall be accompanied by a failure analysis report form.
 - ii). The failure analysis form shall clearly identify the part by description and part number; identify the car and service mileage of that car, the date and nature of the failure.
 - iii). The Contractor shall, within 60 days, provide Amtrak with the results of a root cause analysis for the failure along with any proposed action in the Reliability Report.
- e). Reliability Design Modifications or Changes
 - i). The Contractor shall make necessary modifications during the reliability demonstration program in order to achieve the MDBCF and MDBSF requirements.

- ii). The Contractor shall submit all requests for such design changes within 60 days of the end of the reliability demonstration using the Engineering Change Request (ECR) system and shall gain Amtrak approval prior to the implementation of any change.
 - iii). All reliability-related modifications defined during the reliability demonstration program shall be implemented on all cars and spare parts within 180 days of the date of approval of the modifications by Amtrak.
- f). Reliability Demonstration Duration and Conclusion
- i). The Reliability Demonstration will commence with the Approval for Revenue Service of the first trainset and continue until a minimum of two (2) years after the Final Acceptance of the last trainset.
 - ii). Satisfaction of the reliability demonstration shall only be met when the specified availability and reliability requirements for each complete system within the fleet (that is all trainsets installed and commissioned) are achieved based on a consecutive 12-month period of test time.
 - (1) In the event the reliability demonstration is declared failed, the Contractor shall continue testing and extend the test period until the reliability demonstration is successful, unless otherwise directed by Amtrak.
 - iii). If at two (2) years after the Final Acceptance of the last trainset it cannot be determined that all specified reliability requirements have been met, the Contractor shall re-design and modify or replace all such systems, subsystems, components, parts or equipment as needed to achieve the required reliability, at the Contractor's expense, regardless of whether these items have exhibited the defect or failure and regardless of the warranty status.
 - (1) Cars so modified shall undertake a further reliability demonstration of at least six months duration to prove reliability.
 - (2) Modifications shall continue at the Contractor's expense until the specified MDBCf and MDBSF reliability levels are met.
 - (3) Should such modifications not be completed within this six-month period, Amtrak shall have the right, at its sole discretion, to perform any necessary engineering or studies, and to correct the defect or failure.
 - (a) All costs incurred by Amtrak for such engineering and corrective work shall be at the Contractor's expense.
 - (b) Any items replaced by Amtrak during such corrective work will be disposed of by Amtrak in the manner requested by the Contractor and at the Contractor's expense.

- (c) If the Contractor fails to furnish disposition instructions, Amtrak will dispose of such items at the Contractor's expense, where applicable.
- g). Reliability Demonstration Report
 - i). Within 30 days after the completion of the Reliability Demonstration Test, the Contractor shall submit the Reliability Demonstration Report **[CDRL 4-04]** verifying that the reliability requirements of this chapter have been met.
- h). Reliability Demonstration Plan (RDP)
 - i). Prior to the start of Final Design Review, the Contractor shall submit for Amtrak review and acceptance a Reliability Demonstration Plan (RDP) **[CDRL 4-05]**.
 - ii). The RDP shall define the specific procedures, facilities, staffing, and protocols to be employed by the Contractor during the Reliability Demonstration to monitor, test, adjust, and report progress toward achieving the reliability requirements of this Specification. Specifically, the Contractor shall provide a procedure to be followed for the reliability demonstration that includes, as a minimum:
 - (1) Method for all equipment failures to be reported during reliability testing, including forms and reliability database.
 - (2) The reliability program shall utilize failure data collected through the failure tracking process.
 - (3) Monitoring of overall car reliability on car and component level.
 - (4) Tracking of all component failures and identification of Fleet Defect.
 - (5) Details of the burn-in period for each car.
 - (a) All equipment failures during the burn-in shall be reported and recorded, but not counted in establishing MDL values.
 - (6) Procedure for corrective action when necessary to meet reliability requirements.
 - (a) This shall include proposed reliability demonstration restart procedures, proposed changes, and appropriate supporting data.
 - (b) The proposed plan shall clearly identify a specific method for verifying the effectiveness of change(s).
 - (c) Credit may not be taken for time from previous failed tests, and the specified performance and other required characteristics of the equipment shall not be changed to achieve reliability requirements.

- (7) Method for recording all relevant data necessary to calculate MDBC values for the car and major systems and to verify successful demonstration of the MDBC requirements.

i). Fleet Defects

- i). In the event any single failure mode develops (as distinct from failures due to all or various causes) on a single line replaceable unit (LRU) and in which the rate of such failure reaches five percent (5%) and is present on a minimum of four (4) trainsets, or in the event that a notable pattern of failure develops to take care of phenomena like extreme weather that cannot be demonstrated in any twelve (12) month rolling window and whereby the fault is consistent and reproducible and in which the rate of such failure reaches five percent (5%), of the Amtrak long distance trainset fleet in any twelve (12) month period prior to the expiration of the general warranty period of the last vehicle accepted and of the warranties as defined in this chapter or any extensions thereof.
- ii). In the event any single or cumulative failure mode develops, the contractor shall repair, adjust, redesign, or replace all items in the fleet at no cost to Amtrak. Such correction shall be to Amtrak's satisfaction and shall include correction to all vehicles, including those for which the warranty has expired.
- iii). Vehicles shall be monitored once they are accepted for revenue service, continuing through the end of their warranty coverage. The contractor shall track and report all failures on equipment accepted for revenue service. Monthly reports shall be submitted to Amtrak documenting the current and cumulative failure totals for the equipment and vehicles. The format and structure of the report shall be submitted to Amtrak for review and approval at least three months before delivery of the first vehicle.
- iv). The Contractor shall maintain a database of all failure types. When any one item reaches a failure ratio equal to half that for declaring a fleet defect, that item shall be flagged and reported in the next monthly status report.
- v). Amtrak may classify the total of such items as a failure, or fleet defect, including those items for which the warranty period expired before Amtrak recognized the failure.
- vi). The Contractor is responsible for failure analysis, corrective action and all costs of labor and material, for defect identification and location, and for removal, repair or replacement of defective parts, and for alterations, repairs, tests and adjustments in connection therewith made to obtain car performance identified in the technical specifications.
- vii). Replaced or repaired items due to a fleet defect are warranted and guaranteed for the remainder of the warranty period or for one (1) year, whichever period is greater.

4.6 Design Changes after Pilot Trainset delivery

- a). If during or after Pilot Trainset testing and commissioning design changes are

deemed necessary for any reason, including Fleet Defects, the Contractor shall formally submit such change for approval through an Engineering Change Notification (ECN).

- b). The ECN shall include all supporting information and shall be subject to Amtrak review and approval, including reason for change, updated drawings and other documentation, modification plan and schedule, impacted production vehicles, detailed Field Modification Instructions (FMI) as appropriate, and any other data required to allow the Authority to fully evaluate the request.
- c). The ECN shall also present which vehicles shall require an FMI and which shall incorporate the modification into the production process.
- d). FMI configuration management should be managed using a sharable database to follow the various steps to get the FMI implemented.
- e). To support what is usually an extended FMI period, the Contractor shall develop and submit during the FDR Phase of Design Review an FMI Plan for submittal to Amtrak for review and approval **[CDRL 04-06]**. This plan should include what accommodations the contractor will require such as roof access, pit access, drop table/car jacks, FMI duration, uncouple, and so on.

4.7 Maintainability

- a). General
 - i). The Contractor shall consider maintainability and its effect on the total cost of ownership of these vehicles throughout the vehicle design process.
 - (1) The general goal shall be to maximize the ease of testability, reparability, and maintenance of equipment and components that affect system operation during the car useful life.
 - (2) The quantifiable goal of the designing for maintainability shall be that the target for Mean Time To Repair (MTTR) for running repairs and troubleshooting target shall be 30 minutes.
 - ii). Initiatives which may improve the maintainability of the vehicles may include:
 - (1) The use of modular design.
 - (2) Inter-changeability of components performing similar functions.
 - (3) Accessibility of components and fasteners.
 - (4) Moveability of replaceable components.
 - (5) Reparability including appropriate Maintenance Manual data.
 - (6) Appropriate self-test features.
 - (7) Built-in quick disconnect test points for air and electrical systems.

- (8) Design of simplified test equipment for use as troubleshooting aids.
 - (9) Minimize the use of specialized tools to replace components.
 - (10) Equipment covers and access panels incorporate rugged, quick-removal fasteners.
 - (11) Use of consistent fastener types, where applicable.
- iii). The car shall be designed and built to minimize maintenance and repair time and overall costs over the car life. The following shall be considered good practice in designing for maintainability and shall be utilized in the car design:
- (1) All systems and components serviced as part of periodic preventive maintenance shall be readily accessible for service and inspection from under the car (from a pit), from ground level or from inside the car. Periodic maintenance shall not require the use of cranes or fall protection.
 - (2) Removal or physical movement of components unrelated to the specific maintenance and repair tasks involved shall be minimized or eliminated.
 - (3) Relative accessibility of components, measured in time to gain access, shall be inversely proportional to frequency of maintenance and repair of the components. (Items requiring more frequent maintenance shall be easier to access).
 - (4) Items which may need to be accessed while operating over the road, including cut-out cocks to keep the train moving or portions of systems operating even when some components have failed, must be readily accessible by the crew. Access from within the car is best. If necessary to place it undercar or in the equipment room, it must be within easy reach the side of the car.
 - (5) Assemblies and components that are physically interchangeable shall be functionally interchangeable.
 - (6) Modular or plug-in assemblies and components that are not functionally interchangeable shall not be physically interchangeable.
 - (7) Systematic fault isolation procedures shall be developed for inclusion in the maintenance manuals.
 - (8) Local built-in test points and fault/status indicators shall be provided and clearly marked for all major systems including friction braking, Heating, Ventilation and Air Conditioning (HVAC), passenger doors, auxiliary power, battery charger, Public Address (PA), wi-fi, digital trainline, toilet system and food service equipment (chillers).

- (9) All test points, fault indicators, modules, wire terminations, piping, tubes, wires, etc., shall be identified by name plates, color coding, number coding or other means to assist the maintenance personnel.
 - (10) Component placements in equipment cabinets, enclosures or confined places shall give the most accessible positions to those items requiring the most frequent maintenance or adjustment. For example, the large roomette, the toilet room and kitchen equipment.
 - (11) Door panels and openings shall be of sufficient quantity, size and placement to permit ready access from normal work areas.
 - (12) Standard, commercially available components and hardware shall be used wherever possible.
 - (13) Captive fasteners shall be used on covers and access panels where periodic maintenance and inspection are to be carried out. The use of special tools for removal shall be avoided.
 - (14) Cabinets and access panels will prioritize the use of quarter-turn hardware, pencil latches, and coach keys. Special keys are only allowed with express permission from Amtrak Access shall be provided, to the greatest extent possible, to structural components to allow inspection for cracks and corrosion.
 - (15) Major components shall be designed for ease of removal. Handles and lifting eyes shall be provided as applicable, on heavy equipment and components not readily accessible.
 - (16) Means shall be provided to verify the operability of redundant hardware components, and their switching devices, during maintenance, troubleshooting and testing.
 - (17) Requirements for special tools and fixtures shall be minimized.
 - (18) Any component that may need to be removed from inside the car needs to easily be able to fit through window openings, end doors, access door/hatch or the lower body doors after the car is fully fitted-out and in service. Any component that will need to be brought to the lower level for removal will weigh less than 50 pounds or have a special tool created to safely move the component to the lower level for removal.
 - (19) Required list of tools for each task shall be provided.
- b). Maintainability Plan
- i). The Contractor shall prepare and submit for review at PDR, a Maintainability Program Plan **[CDRL 4-07]** utilizing design standards that minimize Mean Time To Repair (MTTR), cleaning and maintenance costs throughout the car's intended useful life.

- ii). The plan shall include the systems and car MTTR goals for the proposed car.
 - iii). An overall quantitative maintainability requirement goal for the car's corrective maintenance shall be the weighted average of the MTTR (Mean Time To Repair) of the key system elements.
 - iv). Diagnostic and set-up time shall not be included in the MTTR.
 - v). Preventive maintenance is defined as the maintenance tasks performed to minimize the possibility of future equipment failure, reduce or minimize wear rates, replace consumable parts, and satisfy warranty requirements.
 - vi). The elapsed time required to perform preventive maintenance (exclusive of servicing) on the car shall be demonstrated.
 - vii). The objectives of the maintainability program, including corrective and preventive maintenance, shall provide for:
 - (1) Maximization of car availability
 - (2) Minimization of maintenance costs, including cleaning
 - (3) Minimization of car down time
 - (4) Minimization of special and high skill levels for maintenance
 - (5) Minimization of special tools and fixtures
 - viii). Components and sub-assemblies requiring occasional removal shall be plug-in units, adequately identified and secured and keyed to prevent misapplication.
 - ix). The need for adjustments shall be avoided wherever possible.
 - x). Adjustment points shall be readily accessible, adequately identified and self-locking to prevent inadvertent operation and drift.
- c). Mean Time to Repair Requirements
- i). The Mean Time To Repair (MTTR) a car fault and restore the car to operational readiness shall not average more than 1.5 hours including diagnostic and set-up time.
 - ii). MTTR shall be defined as the average time required to fix a failed component or device and return it to production status, including time needed for the maintainer to diagnose, access, remove, replace/repair, close, and test-out the failed component or device.
 - iii). MTTR shall not include logistics time.
 - iv). The weighted average of the MTTR values for the following subsystem elements shall be no greater than:

Figure 4-2: MTTR Requirements

System	MTTR or Replace Major Module (hours)
Braking System	1
Side and End Doors	0.5
HVAC System	1
Couplers	2
Trucks and Suspension	1.5
Auxiliary Electrical System	1
Lighting	0.5
Wheels and Axles	1.5
Communications Systems	1
Water and Waste System	1
Food Service (Café, Diner and Lounge)	1
Sleeping Accommodations	1
Wheelchair Lift	1
Toilet room	1
Truck Monitoring Equipment	0.5
Elevator	2

v). Maintainability Analysis

- (1) As part of FDR, the Contractor must submit a Maintainability Analysis **[CDRL 4-08]** per type of car for Amtrak approval.
- (2) The maintainability analysis must:
 - (a) Demonstrate the MTTR requirement based on all LRU failure rates as well as their replacement times.
 - (b) Include all scheduled maintenance tasks and their time estimates.

vi). Life Cycle Cost Analysis (LCC)

- (1) The Contractor must submit a Life Cycle Cost Analysis (LCC) **[CDRL 4-09]** at FDR.
- (2) The LCC analysis must estimate all maintenance costs as well as overhaul costs to determine the cost of maintenance during the vehicles service life.
- (3) An estimated life cycle shall be provided for all major components and LRU's.
- (4) These documents must be approved prior to final approval of FDR.

d). Maintainability Demonstration

- i). The Contractor shall perform a formal maintainability demonstration.
- ii). The procedures used in the maintainability demonstration shall be the same as those included in the maintenance manuals delivered.
- iii). The maintainability demonstration must be held at the Contractor's facility or the facility of a sub-supplier.
- iv). Maintainability Demonstration Plan **[CDRL 4-10]**
 - (1) The Contractor shall submit a Maintainability Demonstration Plan based on MIL-HDBK-470 for Amtrak approval prior to qualification testing of the first car.
 - (2) The Plan shall include a list of tasks to be performed during the demonstration for Amtrak approval.
 - (3) The Plan shall also include the template that will be used to record the results of the maintainability demonstration of each task, including fields to record the task name, time to access, remove, replace/repair, close, and test-out the component.
 - (4) The maintainability demonstration shall include:
 - (a) preventive maintenance
 - (b) corrective maintenance
 - (c) train recovery
 - (d) accessibility
- v). The preventive maintenance demonstration shall include the periodic inspections and any preventive maintenance tasks identified by the Contractor during the Maintenance Analysis.
- vi). The corrective maintenance demonstration shall include change-out of LRUs and LLRUs and use of special tools where special emphasis, instruction, or proficiency is needed.
- vii). The LRU and LLRU change-outs shall demonstrate compliance with the MTTR requirements of each system element.
- viii). The adequacy of the car design for maintainability shall be evaluated to the satisfaction of Amtrak using product components and equipment, mockups and actual cars during the design, production and acceptance phases.
- ix). The maintainability of following systems shall, as a minimum, be demonstrated. However, Amtrak reserves the right to request the demonstration of additional systems.
 - (1) Braking System

- (2) Side and End Doors
 - (3) HVAC System
 - (4) Couplers
 - (5) Separation and Recoupling of Equipment
 - (6) Trucks and Suspension
 - (7) Auxiliary Electrical System
 - (8) Lighting
 - (9) Wheels and Axles
 - (10) Communications Systems
 - (11) Water and Waste Systems
 - (12) Food Service (Café, Diner and Lounge)
 - (13) Sleeping Accommodations
 - (14) Onboard Mobility Device Lifts
 - (15) Toilet rooms
 - (16) Truck Monitoring Equipment
 - (17) Elevators, Cart Lifts and Dumbwaiters
 - (18) Digital Train Line
 - (19) Wi-Fi
 - (20) Skylight Windows (Option)
 - (21) HEP Backup Power (Option)
- x). This demonstration shall include a shop exercise to troubleshoot, to change out of components, to perform corrective maintenance, and to use the Contractor supplied special tools and equipment.
- xi). The demonstration shall also consider train-car lifting and crane access when developing the maintainability demonstration plan and maintenance manuals.
- e). Maintainability Demonstration Conclusion
- i). If at the end of the demonstration it cannot be determined that all specified maintainability requirements have been met, the Contractor shall re-design and modify or replace elements as needed to achieve acceptable maintainability at the Contractor's expense.

- ii). Cars so modified shall undertake a further maintainability demonstration to prove maintainability.
- f). Maintainability Demonstration Report
 - i). Upon completion of the Maintainability Demonstration Test, the Contractor shall submit the Maintainability Demonstration Report **[CDRL 4-11]** verifying that the maintainability requirements of this chapter have been met.

4.8 CDRL List

CDRL	CDRL Description	Due
CDRL 4-01	Reliability Program Plan	NTP + 30 days
CDRL 4-02	Reliability Progress Reports	Within 90 days following the 1 st FRB, then monthly
CDRL 4-03	Reliability Prediction Analysis	30 days prior to PDR
CDRL 4-04	Reliability Demonstration Report	Reliability Demonstration Test + 30 days
CDRL 4-05	Reliability Demonstration Plan	30 days prior to start of FDR
CDRL 4-06	FMI Plan	
CDRL 4-07	Maintainability Program Plan	30 days prior to PDR
CDRL 4-08	Maintainability Analysis	30 days prior to FDR
CDRL 4-09	Life Cycle Cost Analysis	30 days prior to FDR
CDRL 4-10	Maintainability Demonstration Plan	180 days prior to qualification testing of 1 st car
CDRL 4-11	Maintainability Demonstration Report	Within 30 days after completion of the Maintainability Demonstration Test

* End of Chapter 4 *

Amtrak Long Distance Bi-Level Fleet Replacement

Technical Specification

5. Quality Assurance

Revision 1

Table of Contents

5.1	Overview	5-1
5.2	Regulations, Standards, Specifications and Drawings	5-1
5.3	Quality Assurance (QA)	5-1
5.4	Project Quality Plan	5-1
5.5	Book of Quality	5-4
5.6	Additional Quality Requirements.....	5-4
5.7	Initiatives that Promote Sustainability in the Manufacturing Process.....	5-9
5.8	First Article Inspection (FAI)	5-10
5.9	Inspection.....	5-16
5.10	CDRLs.....	5-23

5.1 Overview

- a). This chapter describes the Contractor quality, manufacturing and inspection requirements for the long-distance fleet.
- b). The Contractor is expected to have an overall Quality Assurance Program that is implemented throughout their organization and a project specific Project Quality Plan, described below.

5.2 Regulations, Standards, Specifications and Drawings

- a). Amtrak takes no responsibility for the identification of applicable chapters and paragraphs of regulations and standards with which the Contractor must comply.
- b). Nothing in this specification shall relieve the Contractor from ensuring that all applicable regulations, standards, and specifications are followed.
- c). The Contractor shall provide proof of compliance with all applicable regulations, standards, and specifications per Section 3.13 b).
- d). The Contractor is responsible for ensuring that all applicable regulations, standards, and specifications are followed when complying with the requirements of this document.
- e). A summary list of regulations, standards and specifications is listed in Chapter 2 as a guide to the Contractor but shall not be construed as complete.

5.3 Quality Assurance (QA)

- a). The Contractor shall develop and implement a Quality Assurance (QA) program that conforms to the latest edition of FTA-PA-27-5194-12.1: *Quality Management System Guidelines*, to assure the delivery of a quality product.
- b). The elements of the QA program shall encompass and control the Contractor's entire organization and all other manufacturers, subcontractors and suppliers that perform work relating to this Contract.
- c). Should the Contractor's QA program be structured following other Quality System standards such as ISO or IRIS, for example, the Contractor shall include in the Project Quality Plan, described below, a cross-reference matrix of the Standard's requirements versus the FTA-PA-27-5194-12.1.
- d). The QA Program shall ensure that all aspects of car design, component manufacture and testing, car assembly and testing, and car commissioning are in full conformance with the design, materials and workmanship requirements provided in these Technical Specifications, and are comprehensively documented.

5.4 Project Quality Plan

- a). Overview
 - i). A Contract-specific Project Quality Plan (PQP) shall be prepared that details when and where in the manufacturing process each element of the

Contractor's and major supplier's organizations will perform specific actions required by the associated QA manual using the quality procedures found therein.

- ii). The PQP shall also specifically identify an adequate number of qualified staff to carry out the required QA tasks and their roles and responsibilities.
- iii). The PQP shall be provided to Amtrak for review and approval sixty (60) days after NTP. **[CDRL 5-01]**
- iv). The PQP shall present how the Contractor shall meet the quality assurance requirements of this Technical Specification.
- v). Required elements of the PQP include:
 - (1) Overview of Contractor's QA program.
 - (2) Contractor's PQP cross-reference matrix of the Contractor's Quality Program elements versus the FTA Quality Management System Guidelines listed above.
 - (3) Corporate organization chart showing how the unit responsible for QA fits into the overall corporate structure, including how it relates to other functional units such as engineering, purchasing, production and warranty, and how QA communicates with those other functions to ensure quality objectives are met.
 - (4) Organization chart for the QA unit, including names, duties and responsibilities, and contact information for QA unit personnel.
 - (5) Specific QA policies, procedures and objectives that are implemented at all stages of the project to ensure that the highest quality is maintained through the life of the project.
 - (6) References to all project management, administrative, design, production, inspection, testing and warranty procedures relevant to the manufacturing and servicing of the coaches.
 - (7) Role of Amtrak in the QA process, including Amtrak design reviews, inspections and hold points, and Amtrak's authority to require corrective action to resolve quality problems.
 - (8) Process for implementing, monitoring, and revising/improving QA policies and procedures, including the means by which QA has the ability to take corrective action to resolve quality problems within engineering, production or testing, and the authority that gives QA the ability to stop production if problems go uncorrected.
 - (9) Process for engineering changes, configuration management, production control and other manufacturing tools to ensure that vendors and production are working to current revisions of all drawings, specifications, policies and parts lists.

- (10) Process for auditing production to determine if QA policies and procedures are being implemented and maintained, and how problems are corrected.
 - (11) Process by which vendors and suppliers are verified to be in compliance with the Contractor's QA program, and the process for ensuring that vendors adhere to the PQP, including source inspections, inbound material inspections, resolving vendor quality problems, certification of parts authenticity and anti-counterfeiting efforts, and long-term parts availability in conformance with contractual provisions.
 - (12) Inspection process for monitoring quality during production, including flow chart and process for resolving defects and closing out non-conformances.
 - (13) Schedule for inspection and recalibration for all tools and devices used for measurement, testing or inspection.
 - (14) Comprehensive inspection plan (see Section 5.9)
 - (15) Process and objectives for defect reduction over the term of production of the cars, including trend analysis, engineering changes if necessary and modifications to inspection and testing processes.
 - (16) Monitoring of post-delivery performance of delivered cars, including evaluation and analysis of fleetwide failures, engineering changes to production, and field modifications to delivered coaches if necessary. Refer to the Technical Support, Spares and Supplies Agreement for applicable failure rates.
 - (17) Process for monitoring the System Safety Program including dedicated resource for managing System Safety.
 - (18) The PQP shall also contain or refer to a comprehensive collection of standard forms to be utilized for documentation of quality control activities.
 - (a) These forms shall be designed to assure compliance of materials, processes, personnel and products to the approved design drawings and applicable specifications.
- vi). The approved PQP and supplemental manuals, procedures and instructions shall be subject to regular scheduled and/or unscheduled audits by Amtrak.
 - vii). A quality organization chart included in the PQP shall show the reporting relationships of all QA management staff.
 - (1) The quality organization chart shall identify that the quality assurance function is fully independent of the production team.

(2) The organization of the Contractor's QA program shall report directly to the General Manager of the Contractor's facility or the Contractor's Project Manager.

(a) In any case it must be completely independent of the Contractor's manufacturing or purchasing divisions.

viii). QA Authority and Autonomy

(1) The PQP shall clearly describe that the Contractor's QA representatives have the responsibility and sufficient authority to ensure that a nonconforming or discrepant product or service will not be used delivered to Amtrak.

(2) The QA personnel shall have complete freedom to identify and evaluate problems; to recommend solutions; to verify implementation of solutions; and to control further processing, delivery, or installation of a nonconforming or deficient item until proper and documented disposition has been obtained.

5.5 Book of Quality

- a). During the construction of the first car of each car type, the Contractor shall develop a Book of Quality for each car type.
- b). The Books of Quality shall be developed and submitted to Amtrak for review and approval prior to the inspection of the first production car of each car type.
- c). The Books of Quality shall be organized starting with zones of visibility, with Zone 1 being most visible to passengers and so on down to completely hidden areas.
- d). The Books of Quality shall clarify inspection and acceptance criteria for all inspection categories such as gaps, flushness, depth of scratches, diameter of dimples, repairs, etc.

5.6 Additional Quality Requirements

- a). QA Organization Responsibility
 - i). The Contractor shall, for the purposes of this Contract, designate a Project Quality Manager who has sufficiently defined responsibility, authority, resources and organizational freedom of action to be in charge of, and implement on behalf of the Contractor, such QA as is required to ensure a proper control of the production process.
 - ii). The QA organization must report independently from production and have fully independent authority to reject unsatisfactory material and subassemblies regardless of any effect on the progress of the Work.
- b). Personnel Qualifications
 - i). The Contractor's QA personnel performing inspections and tests shall be certified for such work.

- ii). Certification of personnel shall be by the virtue of those skills which are obtained by experience or training and verified by testing.
 - iii). All manufacturing personnel performing special processes, such as welding, brazing, etc. shall be trained and AWS certified for such work.
 - iv). Welding inspections shall be completed by AWS certified Welding Inspectors.
 - v). Records of personnel certifications shall be maintained and monitored by the Contractor's QA department. These records shall be made available to Amtrak for review.
 - vi). The Contractor shall, upon request, make measuring and control recordings available to Amtrak for review and provide copies of documentation as requested.
 - vii). The Contractor shall ensure that inspection and tests are based on the latest approved revision or change to drawings, specifications, and all other applicable design documentation.
- c). Revision Control Procedure
- i). Prior to the start of PDR, the Contractor shall develop and submit to Amtrak for review and approval a revision management procedure which controls the adequacy, completeness, change and update of drawings and other design documentation. **[CDRL 5-02]**.
 - ii). This procedure shall be in coordination with the change control system as provided in this Specification and Contractor's configuration management system.
 - iii). The Contractor shall ensure that requirements for the affectivity point of changes are met and that obsolete drawings and change requirements are promptly removed from all points of issue and use.
 - (1) Means of recording the effective points shall be employed and made available to Amtrak.
- d). Non-Conforming Material
- i). Identification and Disposition
 - (1) The Contractor shall establish and maintain an effective and positive system for controlling nonconforming material and/or workmanship, including procedures for its identification, segregation, and disposition.
 - (2) Dispositions allowing the use or repair of nonconforming material or workmanship shall require Amtrak's approval.
 - ii). Segregation of Non-Conforming Materials
 - (1) All nonconforming material shall be positively identified to prevent unauthorized use, shipment or intermingling with conforming material.

- (2) Holding areas and procedures developed by the Contractor and reviewed and accepted by Amtrak shall be established and maintained by the Contractor for the duration of the Contract.
- iii). Corrective Action
 - (1) Corrective action and related information shall be documented and made available to Amtrak upon request.
 - (2) Corrective action shall extend to the performance of all sub-suppliers and include as a minimum:
 - (a) Analysis of data and examination of discrepant products to determine extent and causes with corrective action implemented in an expeditious manner prior to the next shipment, order or inspection.
 - (b) Introduction of required improvements and corrections, initial review of the adequacy of such measures, and monitoring of the effectiveness of corrective action taken.
 - (c) Analysis of trends in processes or performance of work to prevent nonconforming products.
- e). Subcontractor Quality Assurance Requirements
 - i). The Contractor shall require that each subcontractor or supplier establish and maintain a QA program compliant with that of the contractor and acceptable to the Contractor and Amtrak for the services and items it supplies.
 - ii). The Contractor is responsible for all subcontractor and supplier quality and performance.
 - iii). The Contractor shall survey, audit and periodically review each subcontractor and their facilities to assure adequate capabilities to perform subcontracted efforts in compliance with the Contractor's QA program.
 - iv). Each major subcontractor or supplier shall have a QA system that is approved by the Contractor and fully implements the PQP of the Contractor as it applies to the subcontractor or supplier's scope of work.
- f). Quality Assurance Assessments (Audits)
 - i). Amtrak Quality Assurance Audits of Contractor, Subcontractors and Suppliers
 - (1) Amtrak shall, throughout this Contract, have the right to access and visit all facilities of the Contractor, subcontractors and suppliers associated with this contract to conduct initial and on-going assessments (audits).
 - (a) Amtrak will perform scheduled and unscheduled audits of the Contractor's/Subcontractor's/Supplier's quality assurance activities.

- (b) These assessments shall determine if the QA programs are being properly adhered to in compliance with the approved PQP, and that they are producing quality products compliant with the requirements of this Contract.
 - (c) During these assessments, the Contractor shall provide Amtrak personnel reasonable assistance as they inspect production facilities, examine operations in progress and review documentation.
 - (2) At a minimum, the following audits of the Contractor will be performed:
 - (a) During production of the first carshell (will include an audit of both the Contractor and major subcontractors)
 - (b) During manufacturing, installation of equipment, and testing
 - (c) Before acceptance of the first car
 - (3) The Contractor will be notified of other audits to be performed by Amtrak as deemed appropriate.
 - (4) The Contractor will be provided with an audit report containing audit result information following an Amtrak performed audit.
 - (a) If any deficiencies are noted, Amtrak shall provide its findings detailing the identified deficiencies.
 - (b) The Contractor shall implement corrective action and notify Amtrak of the mitigation that was implemented.
- ii). Contractor Quality Assurance Self Audits
 - (1) The Contractor shall perform periodic internal quality assurance audits and inspections throughout the life of the project/during the execution of the Contract to ensure that all QA program obligations are being fulfilled, that all aspects of Amtrak-approved PQP have been effectively implemented, and that all deliverables meet the requirements of the Technical Provisions and all approved drawings and procedures.
 - (2) The Contractor shall provide Amtrak with an internal audit schedule **[CDRL 5-03]** at the onset of the project and whenever revisions to the schedule occur.
 - (3) Deficiencies discovered during the audit process shall be documented and corrected.
 - (a) Corrective actions shall include measures to preclude recurrence of the deficiency.
 - (b) Deficient areas shall be re-audited on an accelerated schedule.

- (4) Amtrak audits and monitoring will be performed independent of and in addition to the Contractor's quality assurance function, but will in no way replace, negate, override or lessen the Contractor's QA obligations.
- iii). Contractor Quality Assurance Audits of Subcontractors/Suppliers
 - (1) The Contractor shall audit subcontractors to assure compliance with the approved PQP.
 - (2) As a minimum, the following audits of each subcontractor shall be performed:
 - (a) Prior to a subcontracted or purchased item being delivered
 - (b) Within thirty (30) days of the scheduled First Article Inspection (FAI), qualification test or the Contractor's acceptance of any supplied items or services
 - (3) Amtrak shall be notified in advance of any scheduled audit and may participate as a witness on any Contractor performed audit.
- g). Quality Assurance Records
 - i). The Contractor shall maintain adequate records of compliance with its QA program plan for the life of the Contract and through any subsequent warranties.
 - ii). These records shall be made available to Amtrak on request, and a complete set of records shall be submitted to Amtrak at the end of the warranty period.
- h). Audit Reports and Corrective Action
 - i). The Contractor shall fully plan and document all quality audit activities performed internally and at subcontractor premises.
 - ii). The Contractor shall develop an audit report within thirty (30) days of each audit detailing any non-compliances found during the audit, corrective action requests and establishing dates by which the corrective actions are required.
 - iii). The Contractor shall submit a Monthly Quality Report (MQR) that describes the status of key project elements described in the PQP as well as all other quality issues affecting the project.
 - iv). The Contractor shall submit its first draft MQR to Amtrak for review and acceptance within sixty (60) calendar days of NTP. **[CDRL 5-04]**
 - v). For the duration of the Contract, the Contractor shall submit a monthly MQR to Amtrak, as part of the Monthly Project Report (MPR).
- i). Monthly Quality Report (MQR) Content
 - i). The MQR shall include, but not be limited to:

- (1) Description of the current status of the design and/or production status of the project
 - (2) Status of PQP open issues
 - (3) Status of Project Quality Management
 - (4) Status of Contractor corrective actions
 - (5) Status of First Article Inspection (FAI) open issues
 - (6) Status of non-conforming material
 - (7) Status of field modifications
 - (8) Contractor's project audit schedule and results
 - (9) Subcontractor and supplier audit schedule and results
 - (10) Project Quality KPIs
 - (11) Contractor's internal activities
 - (12) Vendors and Sub-Contractors activities
 - (13) Software quality assurance audit results; and
 - (14) FRB major issues
- j). Monthly Project Quality Meetings
- i). The Contractor shall hold monthly Project Quality meetings with Amtrak to discuss quality issues and review the MQR.

5.7 Initiatives that Promote Sustainability in the Manufacturing Process

- a). The Contractor shall submit to Amtrak for review documentation regarding initiatives it has undertaken to promote sustainability and reduce the amount of material and energy waste produced by the manufacturing process. **[CDRL 5-05]**
- b). This documentation shall extend to the strategies employed by the Contractor's suppliers and vendors.
- c). These initiatives shall identify how manufacturing waste and energy consumption will be reduced, including tangible and quantifiable goals and the method for monitoring and improving the success of the program.
- d). The waste reduction strategies may include (but are not limited to):
 - i). Creation and utilization of reusable packaging for the transport of materials and components between the facilities of the parts supplier and the Contractor
 - ii). Use of recyclable materials for packaging

- iii). Use of recycled or renewable materials in the production process
 - iv). Reuse or recycling of excess material created during the manufacturing process
 - v). Use of energy-efficient or low-emission vehicles and equipment for transportation and production purposes
 - vi). Capture of reusable or recyclable materials such as office paper, cardboard, copier toner, beverage containers and other post-consumer recyclable material
 - vii). Use of facilities that meet the standards of the Leadership in Energy and Environmental Design (LEED) program
 - viii). Employee awareness campaigns that promote reduction of material and energy waste; and
 - ix). Strategies that promote the reduction of unnecessary use of materials and energy.
- e). The Contractor's waste reduction program shall provide to Amtrak quarterly reports **[CDRL 5-06]** that document the status of the program and the level of success that the program is achieving.

5.8 First Article Inspection (FAI)

- a). General
 - i). The Contractor shall perform a First Article Inspection (FAI) of all major components, subassemblies and fully assembled coaches.
 - ii). Amtrak or its representatives shall be present to witness all FAIs.
 - iii). The Contractor shall perform a satisfactory preliminary FAI on each article prior to notification of Amtrak of an FAI.
 - iv). The Contractor shall lead, document and report on all FAIs.
 - v). FAIs shall be conducted at the manufacturing facility of the material of interest, be it the Contractor, a subcontractor or a supplier.
- b). FAI Plan and Process
 - i). Within ninety (90) days of NTP the Contractor shall develop an FAI Plan and submit to Amtrak for review and approval. **[CDRL 5-07]**
 - ii). The FAI plan shall include the following requirements at a minimum:
 - (1) A list of assemblies, subassemblies and components subject to FAI along with their projected schedule.

- (2) A tracking system to identify each FAI subject and accurately reflect the present status of each inspection. The tracking system shall be maintained through the completion of all scheduled FAIs.
 - (3) The sample for each FAI shall be considered to be complete by the manufacturer and shall reflect the approved baseline drawings.
 - (4) The FAI sample shall have been produced using the production methodology and tooling.
 - (5) Successful completion of engineering tests for the subsystem is a prerequisite for conducting the FAI.
 - (6) The FAI shall be performed using the approved baseline drawings in conjunction with the Technical Specification reflecting specific requirements of the subject along with any special tools and/or equipment needed to verify the design requirements, configuration, and operation (if applicable) of the item being inspected.
 - (7) All technical data required for the maintenance manual and/or parts catalogs shall be submitted as initial drafts prior to the full acceptance of the FAI. **[CDRL 5-08]**
 - (a) The initial drafts shall contain enough information to adequately maintain the equipment during the pilot program and initial production Coach delivery.
 - (8) Amtrak shall be given notice of an upcoming FAI at least thirty (30) days before its schedule date for domestic FAIs and forty-five (45) days before its scheduled date for international FAIs.
- iii). The FAI Plan shall be updated monthly and presented as an attachment to the program meeting minutes.
 - iv). None of the material and/or parts listed in this Chapter of the Technical Specification shall be installed on the equipment unless the FAI has been performed and approved by Amtrak.
- c). Amtrak Participation
- i). For equipment that requires an FAI, the equipment shall not have passed the FAI unless Amtrak or its representative participates in the inspection to its satisfaction.
 - ii). An inspection that requires Amtrak participation but is conducted without a qualified Amtrak representative shall not be considered as having passed.
 - iii). Amtrak reserves the right to waive their own participation of FAIs given that the Contractor has provided the requisite amount of notification of the scheduled FAI.
 - iv). Should Amtrak arrive for an FAI and find the Contractor and/or supplier unprepared, the FAI shall be considered failed.

- v). Should the equipment fail inspection, the problem(s) shall be corrected and re-inspected to Amtrak's satisfaction before the FAI is considered passed and production released.
- d). Systems Requiring FAI Approval
 - i). The FAI Plan shall include a listing of all items proposed to be subject to an FAI. It is noted that this list may be expanded as the design review progresses and additional critical components are identified.
 - ii). At a minimum, the FAI program shall include the following components:
 - (1) Carshell
 - (2) Floor panels
 - (3) Door leaves
 - (4) Door hardware, latches
 - (5) Manual doors
 - (6) Power doors, operators and controls
 - (7) Onboard mobility device lift
 - (8) Elevators
 - (9) Cart lifts and Dumbwaiters
 - (10) Windows
 - (11) Truck-frame
 - (12) Truck-fully assembled
 - (13) Wheel and axle assemblies
 - (14) Couplers and draft gear
 - (15) Air brake system
 - (16) Major fiberglass interior components and hardware
 - (17) Seats
 - (18) Beds
 - (19) Digital signage and displays
 - (20) Tables (workstation)
 - (21) HVAC system, controls and temperature controls

- (22) All external and internal lighting systems
 - (23) Communication system, including Central Diagnostics Unit
 - (24) Food service equipment including refrigeration system
 - (25) Toilet room (modules)
 - (26) Water supply system
 - (27) Waste collection and retention system
 - (28) Sidewall Panels
 - (29) Complete Sleeping Modules
 - (30) Restrooms
 - (31) First completed production car for each car type
- iii). The final approval of all colors and finishes shall also be subject to FAI and acceptance by Amtrak. See Chapter 11 of the technical specification for more information.
 - iv). Equipment shall be shipped from the point of manufacture only after the FAI has been approved.
 - v). FAI's will not be performed unless the design drawings, production processes, production tooling and any other relevant documentation required for the item to be inspected have been approved.
- e). Approved FAI Items / FAI Sample / Golden Unit
 - i). Approved FAI items shall establish the quality of workmanship for the remainder of the same items being produced.
 - (1) That quality shall be well documented.
 - (2) Samples of welds, fit-ups, finishes, and colors, photographs, FAI documentation, etc., shall be retained for the duration of the production phase in a secure area at the Contractor's facilities for reference by the Contractor's and Amtrak's representatives.
 - (3) Changes, modifications or adjustments to this baseline must be approved by Amtrak and will be cause for initiating another FAI by Amtrak.
 - ii). The FAI sample (Golden Unit) shall be retained by the equipment manufacturer and may be installed on the last applicable model of the production cars.
 - (1) Either Amtrak or the Contractor may deny usage of the FAI unit in production if just cause is provided such as configuration control.

- (2) The FAI sample must be stored at the Contractor's facility and must be updated with any modifications throughout the duration of the Contract.
 - (a) This requirement does not apply to any completed car FAI.
- f). FAI Preparation
 - i). Availability of the information in a timely manner is essential to ensure that the appropriate level of Amtrak's technical expertise is available for each FAI and that the individuals have sufficient prior information to inspect the equipment.
 - ii). The Contractor shall provide the following information to Amtrak at least thirty (30) business days before a scheduled FAI **[CDRL 5-09]**:
 - (1) A complete list of the equipment and its bill of materials to be inspected.
 - (2) Identify each completed assembly along with the configuration in which it is to be presented.
 - (3) A copy of the technical Specification for the equipment and the subcontractor's scope of supply.
 - (4) A complete drawing package with current drawing approvals.
 - (a) The drawing package should be in sufficient detail to inspect, at a minimum, the fit and finish of the assembly and subassemblies, wire and pipe routing, clearances between components, ergonomic considerations, and any other details that are required to ensure that the equipment is acceptable for the intended purpose.
 - (5) System schematics, electrical, fluid, pneumatic and piping, with current approvals.
 - (a) The schematics shall be sufficient to determine that the equipment will operate as intended.
 - (6) Routine test report(s).
 - (7) All instruction manuals, operating manuals, maintenance procedures and heavy repair shall be presented at the FAI for review.
 - (8) A report by a recognized independent testing laboratory certifying that all materials used in the equipment comply with the 49 CFR Part 238 Appendix B requirements and NFPA 130, as applicable.
 - (9) All material certifications.
 - (10) Calibration certificates for all routine test equipment and inspection tools.

- (11) An Amtrak-approved FAI and acceptance test procedure and an Amtrak approved qualification test procedure to which the equipment will be inspected. A functional test shall be required as part of the FAI.
- iii). Should any of the above documents be incomplete or otherwise unacceptable to Amtrak, this shall be grounds to delay the FAI until they are made right.
 - (1) The burden of any delay shall be with the Contractor.
- iv). In addition, during the FAI the Contractor shall provide the following, as applicable:
 - (1) The Contractor shall make available all previously submitted and accepted pertinent calculations or analyses that show that the design is adequate for the purpose intended.
 - (2) The Contractor's complete stress analysis and summary, submitted under shall be available during the carshell FAI.
 - (3) All manufacturing variations of specified materials that vary in color, texture, pattern, etc., shall be presented, for approval by Amtrak, at FAI.
 - (a) Samples of acceptable variation extremes will be retained for reference in future inspections.
- v). The FAI shall include a maintainability demonstration for repairs, the removal/reinstallation of consumables, and routine inspections.
- vi). FAIs are considered closed when all FAI open items are closed.
- vii). All the information listed above shall be included in a FAI Binder, that after the FAI is concluded, is submitted to Amtrak for review and acceptance. **[CDRL 5-10]**
- g). FAI Findings
 - i). The Contractor shall provide, within ten (10) business days of each FAI, an FAI report which shall include a copy of all the documents presented and/or discussed at the meeting. **[CDRL 5-11]**:
 - ii). The Contractor shall include an action plan to correct all deficiencies discovered during the FAI.
 - iii). The FAI will remain open until all action items are completed to Amtrak's satisfaction.
 - iv). Depending on the severity of the deficiency, follow-up FAI may be required.
- h). FAI Photographs
 - i). Within thirty (30) days following each FAI the Contractor shall provide color photographs of each item on which an inspection was performed.

- (1) The photographs shall be provided on 8.5 in. by 11 in. size paper and also in a digital format.
- ii). A second set of these photos shall be compiled into an album for Amtrak's reference for future Coach inspections and will be supplied to Amtrak with the delivery of the first Trainset. **[CDRL 5-12]**

5.9 Inspection

a). General

- i). As part of the Project Quality Plan, the Contractor shall include a comprehensive inspection plan covering the processes and procedures proposed to ensure the overall quality and compliance of the equipment under this Contract.
- ii). Amtrak shall, at all times, have the right to inspect any and all work being performed for this Contract.
- iii). The Contractor shall grant Amtrak access to the facilities of the Contractor, subcontractors and suppliers to conduct initial and on-going inspections and assessments of the work to determine if it is being performed in accordance with both the requirements of the Contract as well as all approved design documents.
- iv). During these assessments, the Contractor, subcontractors and suppliers shall make every reasonable effort to assist Amtrak personnel, including the supply of any necessary equipment to access areas of the assembly and all equipment necessary to perform inspections.
- v). Inspection or lack of inspection, approval, or acceptance of any portion of the work by Amtrak shall not relieve or release the Contractor from its obligations to fully comply with all requirements of the Contract documents.
- vi). For hold point inspections, the Contractor shall not progress without approval or a waiver from Amtrak.
- vii). The Contractor shall correct any portion of the work not meeting the requirements of the Contract documents at the Contractor's expense to the satisfaction of Amtrak.
- viii). Amtrak at any time before issuance of final acceptance for any car may order re-inspection of any portion of the work.

b). Inspections and Tests

- i). Inspection of components to be used by the Contractor in performance of the work under this Contract shall be the responsibility of the Contractor
- ii). It is preferable for inspections to be performed at the plant where the respective processes are taking place to give the Contractor and/or supplier every opportunity to correct, under factory conditions, any inadequacies found.

- iii). Inspection of supplier components shall also be performed at the Contractor's plant to identify any damage in transit.
- iv). Amtrak, its representatives and its designees, including the FRA, shall also have the right to:
 - (1) inspect selected items at any time, whether or not accompanied by the Contractor's representative.
 - (a) This shall in no way lessen or eliminate the Contractor's responsibility to make proper inspection.
 - (2) inspect at subcontractor manufacturing facilities any materials, processes, assembly and testing of equipment it deems necessary to validate compliance with the Contract, technical specifications and accepted design documents.
 - (3) have access at all times to those parts of the Contractor's and/or subcontractor's plants in which any portion of the work is performed for the purposes of:
 - (a) inspecting materials and workmanship, and
 - (b) determining conformity to the Specification during the progress of construction and assembly of the equipment.
- v). If any portion of the car shall become hidden by subsequent work contrary to the specific request of Amtrak, that portion of the car shall be made visible for Amtrak inspection by the Contractor at the Contractor's expense (Section 5.8 f).
- vi). Amtrak shall be allowed to participate in all Contractor and/or subcontractor tests and inspections of all components of the equipment, at the Contractor's and subcontractor's plants, for the purpose of QA.
 - (1) Such right to participate shall include Amtrak's right to supplement its on-site inspector with additional experts as necessary according to the particular nature of the test or inspection involved.
- vii). The presence of Amtrak in the plant of either the Contractor or subcontractor shall not, in any way, supplant or relieve the Contractor's responsibility for making proper inspections or meeting the requirements of the Specification.
- viii). Amtrak shall have the right to reject all materials and workmanship that do not conform to the Specification.
 - (1) When 3 or more rejections occur for the same item or component, the Contractor shall prepare a written report for Amtrak detailing the problem(s) discovered during inspection and the efforts to be taken to remedy the problem(s).

- (2) No further acceptance or production shall take place until the Contractor notifies Amtrak in writing that the problems have completely resolved.
- ix). The Contractor shall document the results of both inbound material inspection and outbound Coach inspection and testing for each car.
 - (1) A "traveler" shall be attached to each car to track QA functions as the work progresses through the shop.
 - (2) A copy of the report must be attached to each car through conditional acceptance.
- x). If Amtrak has reason to believe that defective work has been performed or permitted by Contractor, or that defective materials were used, Amtrak may examine any partially or fully completed work.
 - (1) If Amtrak makes such an examination, Contractor shall at its own expense furnish the appliances and labor required by Amtrak to make such investigation and inspection.
 - (2) Any defective or nonconforming work so disclosed shall be promptly corrected by Contractor at Contractor's expense.
- xi). Except as otherwise provided herein, costs incurred by Amtrak in performing or participating in inspections under this Contract shall be borne by Amtrak.
 - (1) However, Contractor shall reimburse Amtrak for Amtrak's costs incurred as a result of any re-inspection resulting from a failed inspection or Contractor's failure to meet a scheduled inspection or where a scheduled inspection was postponed and rescheduled upon less than three (3) days' notice to Amtrak.
- xii). Inspection and Test Log
 - (1) An Inspection and Test Log (Log) shall be maintained by the Contractor during equipment assembly.
 - (2) The Log shall be submitted to Amtrak for review before each Coach will be released for shipment to the delivery site. **[CDRL 5-13]**
 - (3) All Contractor and Amtrak in-process inspection sheets and test data records for that car shall be contained in this Log, which will be provided in the vehicle history book.
- xiii). For those routine inspections and tests of components that are typically performed solely by Amtrak, the Contractor shall give at least 72 hours' notice of such inspections or tests to Amtrak.
 - (1) Amtrak shall be allowed to participate in such Contractor or subcontractor inspections or tests at the Contractor's or subcontractor's plants for the purposes of QA.

- xiv). The Contractor must maintain office copies of all records, and they must be accessible to Amtrak, not more than five (5) days after such notice is given.
- c). Contractor Provisions for Amtrak Inspectors
 - i). From NTP continuously through production, the Contractor shall provide office facilities for Amtrak representatives at no additional cost to Amtrak.
 - ii). Office facilities will be required at the car construction plants, including the final assembly site and the carshell fabrication site (if a separate facility), as well as similar facilities at any car or equipment qualification testing sites for the duration of the tests.
 - iii). These office facilities shall enable convenient inspection of materials, work and equipment under this contract.
 - iv). The office facilities shall be secure, heated, cooled, and adequately lighted private office for a minimum of five people, with access to toilets and a private conference area, and shall be furnished with desks, chairs and lockable locker facilities.
 - v). Desks and file cabinets shall be lockable, and all keys submitted to Amtrak.
 - vi). A minimum of five dedicated telephones with an outside line, high speed Internet connection, access to a photocopy machine capable of high-quality copies shall be provided within Amtrak's office.
 - vii). Reserved parking places shall also be provided for all Amtrak representatives assigned to the Contractor's facility.
 - viii). Amtrak requires that the Amtrak designated office facility be prepared for up to 15 Amtrak individuals working at the facility at one time.
 - ix). All resident inspectors, test engineers and the dedicated Amtrak program team require Contract or badges for access to the plant as well as our office facility.
 - x). Electronic copies of all drawings, manufacturing procedures, test procedures, test reports, test equipment calibration certificates, welder certifications, diagrams, schedules, changes, deviations, revisions and data shall be made available to Amtrak at the same time these are made available to the Contractor's QA department.
 - (1) Data shall be sufficient to verify design, construction, assembly, installation, workmanship, clearance, tolerance and functioning of the coaches.
- d). Scheduling of Inspections and Tests
 - i). Inspection and testing activities by Amtrak staff will normally be conducted during normal daytime shifts and will not be conducted on Saturdays, Sundays or any holidays observed by the Contractor.

- (1) Amtrak staff may be made available in extenuating circumstances outside normal hours, provided a fully substantiated request is made at least forty-eight (48 hours) in advance in writing and is approved by Amtrak.
 - (2) This request will include compensation by the Contractor to Amtrak for this additional expense, as defined in the General Provisions.
- ii). The Contractor shall provide Amtrak a one-week inspection/test look ahead **[CDRL 5-14]** to plan and make resources available.
- iii). In preparation for an upcoming inspection or test, the Contractor shall provide Amtrak with the proposed activity schedule, location and associated processes, procedures and documentation. This information shall be provided to Amtrak per the following schedule:
 - (1) For inspections and testing activities in the Contractor's facilities, the Contractor shall present a written schedule of activities to Amtrak's inspectors at least 24 hours before the activities are to take place.
 - (2) In case an inspection or test proposed for performance outside that standard work schedule of Amtrak's resident inspector, the Contractor shall notify Amtrak at least 72 hours before the scheduled test or inspection.
 - (3) For inspections and testing activities at subcontractor's facilities in the US, after written notice is submitted to Amtrak ten (10) business days prior to the activities, Amtrak will advise within five (5) calendar days whether a representative will attend the inspection or test.
 - (4) For inspections and testing activities at subcontractor's facilities outside of the US, after written notice is submitted to Amtrak forty-five (45) business days prior to the activities, Amtrak will advise within five (5) calendar days whether a representative will attend the inspection or test.
- e). Receiving Inspection
 - i). The Contractor shall provide for the inspection of all incoming systems, subsystems, components, parts, equipment and materials to ensure their conformance with procurement documents and condition.
 - ii). All material certifications and test reports used as the basis for acceptance shall be reviewed for compliance with specifications, retained by the Contractor and kept readily available for inspection by Amtrak personnel.
- f). Manufacturing/Assembly Inspection Hold Points
 - i). The Contractor shall establish inspection hold points in the manufacturing process to provide for critical inspections by the Contractor's quality staff and Amtrak's representative of completed operations/installations or to inspect items that are about to be covered by succeeding assembly operations.

- ii). As part of the PQP, the Contractor shall submit a list of hold point inspections per car type **[CDRL 5-15]** for review and approval, which shall include as a minimum the following:
 - (1) Each carshell section before painting
 - (2) Each carshell section after painting
 - (3) Each truck frame
 - (4) Each assembled truck, prior to installation under a car
 - (5) Each car underfloor area prior to receiving trucks
 - (6) Each carshell water tightness test prior to installation of insulation and interior finishings
 - (7) Each car final water tightness test
 - (8) Each car interior wiring and components before being covered by panels
 - (9) Each car underfloor area and connections prior to concealment
 - (10) Each finished car interior
 - (11) Each finished car exterior
- iii). The Hold Point Inspection Plan shall include a pre-inspection performed internally by the Contractor prior to the inspection witnessed by Amtrak.
- iv). Prior to submitting an invitation to Amtrak inspectors/engineers, the Contractor shall complete its own internal inspection and work off all identified findings.
 - (1) Amtrak may request the results of the pre-inspection prior to the performance of the witness inspection.
- v). The Contractor shall provide Amtrak at least 24 hours advance notice of each such inspection or 72-hours for off-site inspectors/engineers.
- vi). If during manufacturing or testing, a component is replaced after it has gone through a hold point inspection, a subsequent hold point inspection shall be scheduled after the replacement.
- vii). Amtrak reserves the right to add hold point inspections based on inspection findings or changes to the design or production process even after the initial plan had been accepted.
- viii). The Contractor and Amtrak representatives shall use inspection forms to record any discrepancies noted during inspection.

- (1) Nonconforming products shall not be released from a hold point area until all discrepancies have been corrected.
- (2) The inspection forms shall be posted at or near the point of inspection for each car and included in the vehicle history book when all discrepancies have been eliminated.

g). Pre-Shipment Inspection

- i). After all work, including factory static and dynamic testing as per Chapter 20 of the technical specification is completed, the Contractor shall perform the pre-shipment inspection, including function testing of each system, according to an Amtrak approved procedure.
- ii). All manufacturing or testing non-conformance reports shall be closed out and no configuration upgrades or applicable FMIs will be pending before pre-shipment inspection begins.
- iii). The vehicle history book as specified in Chapter 23 shall be complete and ready for review and approval signature by Amtrak.
- iv). The Contractor shall provide a qualified supervisor to accompany Amtrak during inspection to assure that proper corrective action is taken.
- v). The Contractor shall provide Amtrak with labor and appropriate tools to remove or open and reapply covers and doors.
- vi). During inspection, all systems shall be operational with use of approved types of special equipment or power supplies.
- vii). The Contractor shall provide Amtrak 72 hours advance notice of each such inspection.
- viii). Pre-Shipment inspections shall be documented using an Amtrak approved inspection form.
 - (1) Prior to shipment, the Pre-Shipment Inspection Form shall be signed off by both the Contractor and Amtrak.
 - (2) Minor open items shall be documented on the form and be approved by Amtrak.
 - (3) Closure of these Pre-Shipment open items shall be documented and included in the Vehicle History Book for the affected car.
- ix). Any damage to the Trainsets and/or any parts or components thereof which become damaged from any cause whatsoever, during the progress of production or shipping or otherwise before risk of loss has passed to Amtrak, shall be made good at the expense of Contractor or the Subcontractor in whose plant the damage occurs, and with no extension of the Contract Time or increase in the Contract Amount.

h). Shipping Inspection

- i). Following pre-shipment inspection, the Contractor shall ensure the car is properly prepared, protected and loaded for shipment in accordance with approved procedures.
 - ii). For shipments by sea, this shall include all necessary preparations for shipment below decks.
 - iii). Amtrak representative(s) will then perform a cursory walk-through inspection to confirm that the car has been adequately prepared for shipment before issuing a Release for Shipment document to the Contractor.
 - (1) The Contractor shall provide Amtrak 72 hours advance notice of each such inspection.
 - iv). See Chapter 22 for additional shipping requirements.
 - v). Should a car need to be stored for longer than thirty (30) days, the Contractor shall submit a Long-Term Storage Plan to Amtrak for review and approval.
- i). Modification Inspection
- i). The Contractor shall provide written procedures for Amtrak review and approval, for the inspection of any modifications or retrofits arising from engineering changes implemented either at the Contractor’s facility or on Amtrak property.
 - ii). Upon completion of the change, the Contractor shall verify satisfactory completion and modify any quality assurance documentation affected by the change, including the Vehicle history book.
 - iii). The Contractor shall provide Amtrak 72 hours advance notice of each such inspection.

5.10 CDRLs

CDRL	Description	Due
CDRL 5-01	Project Quality Plan (PQP)	NTP + 60 days
CDRL 5-02	Revision Management Procedure	30 days prior to PDR
CDRL 5-03	Internal Audit Schedule	NTP + 30 days
CDRL 5-04	Monthly Quality Report (MQR)	NTP + 60 days, then monthly
CDRL 5-05	Documentation of Initiatives to Promote Sustainability	NTP + 30 days
CDRL 5-06	Waste Reduction Program Quarterly Reports	NTP + 90 days
CDRL 5-07	FAI Plan	NTP + 90 days
CDRL 5-08	FAI – Technical data for maintenance manuals and parts catalogs	Prior to full acceptance of FAI

CDRL	Description	Due
CDRL 5-09	FAI Documentation	30 business days before FAI
CDRL 5-10	FAI Binder	After conclusion of FAI
CDRL 5-11	FAI Report	Within 10 business days of FAI
CDRL 5-12	Complete set of FAI photographs	With 1 st trainset delivery
CDRL 5-13	Inspection and Test Log for each coach	Before release for shipment
CDRL 5-14	Inspection and Test 1-Week Look Ahead	14 days prior to initiation of any manufacturing activities then, every weekly
CDRL 5-15	PQP – List of Hold Point Inspections for each car type	NTP + 60 days

* End of Chapter 5*

Amtrak Long Distance Bi-Level Fleet Replacement

Technical Specification

6. Carbody

Revision 1

Table of Contents

6.1	Overview	6-1
6.2	General Requirements	6-1
6.3	General Design Details.....	6-2
6.4	Structural Design Details	6-7
6.5	Truck to Carbody Interface	6-15
6.6	Doorways and Passageways.....	6-15
6.7	Gangway	6-16
6.8	Elevators, Lifts and Food Service Lifts.....	6-17
6.9	Safety Appliances.....	6-20
6.10	Equipment, Equipment Boxes, Equipment Rooms and Access Doors.....	6-21
6.11	Windows.....	6-26
6.12	Insulation.....	6-29
6.13	Exterior Finish	6-31
6.14	Graphics and Labels.....	6-32
6.15	Automatic Equipment Identification (AEI) Tags.....	6-32
6.16	Stress Analyses.....	6-33
6.17	CDRLs.....	6-38

6.1 Overview

- a). This chapter defines the structural performance characteristics of the trainset and the individual carbody shells. It also lists analysis and other submittal requirements.
- b). For the purposes of this specification, a trainset is defined as a collection of passenger cars which are coupled to create a fixed consist to be used for a particular train application.
- c). The structure of the cars shall be independent from each other and capable of meeting all structural requirements on a stand-alone basis.
- d). The trainset and car structures shall comply with the latest applicable APTA recommended practices and FRA passenger equipment requirements and shall minimize weight to the greatest extent possible.
- e). All required standards shall utilize the most recent revisions available at the date of NTP.
- f). If contradictions arise between this Technical Specification, APTA recommended practices, and/or FRA requirements, the more stringent shall be used unless otherwise approved by Amtrak.
- g). All materials and workmanship shall comply with the requirements of Chapter 19.

6.2 General Requirements

- a). The design of each carbody shall be compliant with the Tier I requirements of the FRA contained in the 49 CFR Part 238. Specifically, the carbody shall comply with 238.203 through 238.219 without utilizing alternative compliance.
- b). Each carbody's design shall conform to the applicable sections of the most recent edition of the APTA-PR-CS-S-034 standard, "Design and Construction of Passenger Railroad Rolling Stock," as of the time of the Notice to Proceed (NTP).
- c). In the selection of the type and thickness of material to be used, the Contractor shall be guided by the desire to obtain the maximum strength and reliability with the minimum weight and minimum number of different material grades which is obtainable at reasonable cost.
- d). The Contractor shall base its structural design on the specific loads, deflections and properties of structural sections called for in this Specification.
- e). For structures not specifically covered, the Contractor shall base its design on its experience, subject to successful stress analysis and structural testing.
- f). The structure and equipment supplied shall resist these loads, including fatigue loads, with factors of safety consistent with those which have previously been shown to be successful for existing North American Intercity passenger equipment for service at maximum design speed.

6.3 General Design Details

a). General

- i). The structure of the individual carbody shells of the trainset shall be designed and manufactured to provide for the mounting and functioning of all the elements/features defined in this Specification, including:
 - (1) Passenger seating and related convenience features
 - (2) Doors, passageways, windows, and emergency exits
 - (3) Mechanical elements such as trucks, brakes and HVAC
 - (4) Electrical elements such as lighting, communications, and control trainlines
 - (5) Accessibility equipment as required by ADA requirements
 - (6) All ancillary equipment
 - (7) Gangways
 - (8) Elevators and wheeled mobility devices
- ii). The general arrangement of carbody shells, layout/mounting of the subcomponents, and equipment access setups shall be approved by Amtrak during the mockup and design review process described in Chapter 3.
- iii). Key structural areas of the carshell shall be possible to visibly inspect with minimal disruption to room modules.

b). Dimensions, Weights and Under Car Clearance

- i). The individual cars and completed trainset shall meet the dimensional and clearance drawing requirements stated in Chapter 1.
- ii). Each completed car shall comply with the minimum allowable clearance above top of rail for the carbody and all associated components under the worst combination of conditions, including fully worn wheels, solidly compressed or broken springs, AW3 passenger load, carbody deflection to zero camber and environmental conditions including wind, snow and ice.

c). Physical Requirements

- i). The carbody structure shall be designed to prevent water, snow, debris or dust ingress when operating at any permissible speed up to maximum design speed under all weather conditions consistent with the worst case climatic data as specified in Amtrak Specification 963.
- ii). The carbody shall be designed to be watertight for a service life of at least 40 years, without maintenance.

- iii). Housings for externally mounted equipment shall be completely watertight when covers are in place, excluding battery boxes and the HVAC unit, which shall be designed to prevent water intrusion while allowing adequate ventilation and air flow.
 - iv). Pneumatic equipment that can tolerate environmental exposure may be mounted in an unsealed container per manufacturer's recommendations.
 - v). Drain holes shall be provided to prevent the accumulation of water.
 - vi). Exterior surfaces and structural members shall not contain pockets that may accumulate or retain water or debris.
 - vii). Exterior structural pockets with flat bottom surfaces shall, at a minimum, include drain holes.
 - viii). The carbody shall be designed for ease of accident repair, including replacement of any CEM components, CEM structural zones skin panels, and any undercar components or covers.
 - ix). The Contractor shall review these and other aspects of the carbody design with Amtrak during the design review process.
 - x). The Contractor shall include accident repair procedures as part of the deliverables, which will cover a range of scenarios identified by Amtrak, including sideswipes, dragged rolled-over equipment, strike damage to the lead end of the end car and sides of all cars, and automotive grade crossing collision damage to the underframe components of all cars.
 - xi). Some recommended design techniques consist of use of spot welds, and not seam welds, for attachment of the visible exterior side sheathing, and the routing of underfloor car piping and electrical cables as far inward from the end sheathing and as close to the center sill as possible.
- d). Carbody Materials
- i). Materials used in carbody construction shall be in accordance with APTA Standards PR-CS-S-034, PR-CS-S-004-98, PR-CS-S-015 and the requirements of Chapter 19.
 - ii). The carbody shall be constructed of either stainless steel, American Iron and Steel Institute (AISI) type 301LN or approved equivalent.
 - iii). Components such as bolsters, end draft sills, end sills/anticlimbers, structural shelves, corner posts and collision post stubs may be fabricated from High-Strength Low-Alloy (HSLA) steel per American Society for Testing and Materials (ASTM) A588, or approved equal.
 - iv). Selected steel shall have inherent corrosion resistance equal to or greater than A588 when evaluated per ASTM G101, paragraph 6.3.1.1.
 - v). All welding and fastening shall conform to the requirements of Chapter 19.

- vi). Other alternate materials and fabrication techniques providing equivalent strength, fatigue resistance and performance goals may be proposed by the Contractor for Amtrak approval.
 - vii). The method used by the Contractor to prevent corrosion from the inside surfaces of closed structural sections (i.e., inside of tubular sections) shall be identified at the design review. **[CDRL 6-01]** At a minimum, each such element shall include a drain hole.
 - viii). There shall be no corrosion that reduces the load carrying ability below the design strength requirements for the design life of the vehicle.
 - ix). This can be met by material selection, coating or corrosion allowance and shall be submitted for review and approval at the design review.
 - x). Cross sectional views shall be provided on carshell drawings and must be submitted for approval at the design review.
 - xi). Drawings must be submitted not only of individual structural members, but all sub-assemblies and assemblies in order to have a clear record of the carshell assembly construction and process.
 - xii). Carshell drawings shall be submitted for Amtrak review and approval 30 days before starting the fabrication of any components for the carbody structure.
 - xiii). The drawings shall show the location of all principal framing members, their cross sectional area, material, metal thickness along with detailed type and method of joining and applicable references to Welding Procedure Specifications.
 - xiv). Bill of materials shall be provided to link the drawing number and location each part in it's assembly level drawing.
 - xv). Thickness of all sheathing materials shall be provided.
 - xvi). This information shall be of sufficient detail to permit manufacture of any structural parts necessary to repair damage to a car.
- e). Carbody Exterior Finish
- i). Specifications and samples for all external surfaces meeting the grit requirement of Section 19.5.d). shall be submitted for review and approval. **[CDRL 6-02]** Three samples of all exterior finishes shall be submitted to Amtrak for approval.
 - ii). These approved samples shall then be used throughout the program as references to maintain quality.
 - iii). All exterior surfaces shall be free of ripples and buckling.

- iv). Dents, gashes or other surface imperfections shall not be permitted. Maximum allowable variation from a straight line, the designed curved line, or the designed profile of a corrugated exterior sheet shall be as follows:
 - (1) All exterior side and roof surfaces not hidden by covers or shrouds shall have a maximum 0.09375 in. variation (peak to valley) in 3 ft measured in any direction or 1/300 of the span between adjacent members or areas questioned as ripples.
 - (2) Areas within 8 in. of the side doors and vehicle ends may have a gradual slope towards the doors and ends with a maximum deviation of 0.1875 in. from the side sheet contour.
 - (3) Exterior surfaces hidden by covers and shrouds shall have a maximum 0.3125 in. variation (peak to valley) in 3 ft measured in any direction.
 - (4) All other sheet metal exposed to view, inside or outside the assembled vehicle, shall have a maximum variation from a straight line on flat surfaces measured in any direction of 0.1875 in. and 0.125 in. over a distance of 36 in. and 12 in.

- f). Fabrication
 - i). The carbody shall be fabricated so that the shells are identical to the maximum extent practical.
 - ii). The level of tolerance in different dimensions of carshell build shall be identified in the design process.
 - iii). Undercar and interior components shall be designed to accommodate those tolerances while remaining interchangeable between cars.
 - iv). Unless otherwise approved by Amtrak, the carbody shall be assembled using fusion welding or resistance welding.
 - v). Connections consisting of primary structural members shall be designed so that the ultimate strength of the connection exceeds the ultimate strength of the weakest member joined.
 - vi). Mechanically fastened connections used in the construction of the carbody structure should be avoided; however, rare exceptions can be submitted for Amtrak approval with fatigue analysis and a factor of safety of 2.0 based upon the proof load for limited connections.
 - vii). Clamping force friction shall be ignored in the design and analysis of mechanically-fastened connections.
 - viii). Self-tapping screws shall not be used for structural connections.
 - ix). Fabrication practices shall ensure that the life of the vehicle is not shortened because of fatigue, corrosion, breakage or wear.

- x). Maintenance practices shall be considered so that parts are not easily lost and cannot be installed in more than one orientation.
 - xi). Fasteners shall be captive wherever practical.
 - xii). A sufficient number of jigs, fixtures and templates shall be used to assure interchangeability of components and uniformity of structure throughout the fleet.
 - xiii). Parts of the bodies, such as underframes, side frames, end frames and roofs shall be built on jigs.
 - xiv). All weld and bolt patterns shall be identical on all cars.
 - xv). Visible weld and bolt patterns shall be uniform and symmetrical and shall be submitted for review and approval by the Authority. **[CDRL 6-03]**.
 - xvi). All equipment hangers shall be interchangeable on all cars without the use of shims or elongated holes.
- g). Equipment Access
- i). Apparatus and truck equipment requiring frequent inspection or attention, including any element of a CEM system that requires periodic inspection to confirm serviceable condition, shall be readily accessible and replaceable.
 - ii). The frequency of required service shall govern the degree of accessibility. Apparatus requiring attention more frequently than every 184 days, or in emergencies, shall be accessible from the side of the car or from the inside of the car unless specifically approved by Amtrak.
 - iii). All undercar shrouds shall be spaced a minimum of 3 ft. from the adjacent truck to permit ease of truck access at outlying maintenance points not having a maintenance pit.
 - iv). All other underfloor apparatus shall be arranged to provide ready access from the side of the car.
 - v). All equipment and apparatus weighing more than 50 pounds shall be capable of ready replacement by forklift truck from the side of the car, or by overhead crane through appropriately sized roof access panels and lifting eyes.
 - vi). All protective devices on the car shall be accessible to maintenance personnel from the side of the car.
 - vii). For purposes of this section, protective devices shall include devices requiring replacement or resetting to move the car or cause auxiliaries to function, such as air brake cut outs, circuit breakers, fuses, latching protective relays, etc.

- viii). Locations for all protective devices shall be identified on arrangement and installation design drawings and approved by Amtrak.
- ix). Apparatus supports, and housings shall be mounted interchangeably.

6.4 Structural Design Details

a). Level

- i). The difference in height Above Top of Rail (ATOR) of the four corners of each finished car shall not exceed $(1/2750)$ of the carbody length, measured at the car ends.
- ii). The measurement shall be made on the completely assembled and equipped car mounted on its completed trucks at AW0.
- iii). The measurement may be made from any suitable structural member of the underframe and shall be documented in each vehicle history book.

b). Camber

- i). Carbody camber shall be defined as its vertical curved shape as viewed in side elevation and shall have a smooth curvature from end-to-end of the carbody.
- ii). Each completed car shall have a positive camber not to exceed $(1/2000)$ of the carbody length under AW1 conditions.
- iii). It must be designed so that under full AW3 load, and for the life of the car, a negative camber does not occur.
- iv). The maximum difference between the cambers of each side sill, measured at the location of maximum deflection, shall not exceed 0.125 in.
- v). The Contractor shall evaluate and submit camber values at AW0, AW1 and AW3 load for approval at the design review.
- vi). Camber requirements shall be validated during the AW3 vertical load test.

c). Removable Plug Doors

- i). If removable plug doors shall be provided to seal side access openings on all car types, the plugs shall blend aesthetically with the car sides and function as an integral part of the car structure.
- ii). Construction of the plug doors shall be in accordance with Chapter 19.
- iii). The plug doors shall be secured to the carbody with removable captive fasteners unless otherwise approved by Amtrak.
- iv). The seal between the plug door and carbody shall be watertight for the life of the carbody.

- v). If removable plugs are utilized, they shall be considered as part of the carbody structural analysis.
- d). Strength, Stiffness and Fatigue Requirements
 - i). The strength of the carbody, and all carbody components, shall meet the Tier I requirements of 49 CFR Parts 229 and 238.
 - ii). All safety critical structural connections that are in an impact load path shall be designed so that, in case of excessive impact, failure shall be by buckling or crushing of structural elements rather than by shearing of structural elements or by failure of connections between elements.
 - iii). The trainset cars shall also be designed, at the minimum, for the worst loading case arising out of the possible simultaneous combinations of the following operational loads acting on the car:
 - (1) Car tare weight (AW0)
 - (2) Crush passenger load (AW3)
 - (3) Vertical, lateral and torsional dynamic load due to wheel/rail interaction
 - (4) Loads due to vehicle pitching caused by braking
 - (5) Snow or ice loads
 - (6) Aerodynamic loads.
 - (7) Train passing wind loads: Compressive and lateral loads caused by another train passing in the opposite direction on an adjacent track with relative speeds of 330 mph
 - (8) Buff/draft loads
 - (9) Racking or torsional loads
 - iv). The carbody strength shall be sufficient to permit operation under the above defined loads for the design life of the car (40 years) without structural damage, including fatigue cracks.
 - v). For the operational cases defined above, the stresses in the carbody shall not exceed the lesser of 50% of the guaranteed minimum material yield or the buckling strength.
 - vi). The buckling strength of all structural members with a compressive stress equal to, or greater than 35% of its material's yield strength shall be calculated.
 - (1) Any variations in the material compression moduli with stress shall be addressed in the buckling strength calculations.

- (2) These calculations shall also address the inelastic buckling strength of structural members subjected to any combination of compression and shear.
- e). Natural frequency
- i). The FEA model shall be used to calculate natural frequency of the carbody under AW0 and AW3 load and supported at the bolsters.
 - ii). The natural frequency of the carbody under AW3 load, and rigidly supported at the bolsters, shall be no less than 2.5 times the natural frequency of the car's secondary suspension system.
- f). Fatigue
- i). The carbody shall be designed to permit operation under nominally expected operational loads in the three orthogonal directions and about the torsional axis, for the design life of the car (40 years) without fatigue cracks/issues.
 - ii). Fatigue critical joints and members shall be identified using an appropriate analytical method such as finite element analysis (or alternate method as approved by Amtrak). The key load cases from a fatigue consideration are:
 - (1) Vertical loads from car weight and passenger loads (from AW2 loading)
 - (2) Load input at the carbody/truck interface due to vehicle-track interaction
 - (3) Load input at the coupler interface due to traction and braking
 - iii). Compliance with the design life requirements shall be demonstrated through cumulative damage analyses on all potential fatigue critical locations.
 - iv). The methodology for the cumulative damage analysis shall be approved by Amtrak.
 - v). Load spectra for the cumulative damage analyses may be obtained from the following:
 - (1) Actual test data from existing equipment that is substantially similar, running on similar North American track and having similar braking/acceleration profiles.
 - (a) Details on any dissimilarities shall be provided and suitably accounted for.
 - (2) Dynamic analysis of vehicle performance under the appropriate modes, the results of which must be verified by test on the first vehicles.

- (3) For the vertical direction, the number of cycles in the life of the vehicle calculated from the first free-free vertical bending mode natural frequency of the car. This will give a constant amplitude loading, the dynamic factor for which shall not be less than $\pm 20\%$.
 - vi). Alternatively, an endurance limit analysis may be used for materials that have an established endurance limit, such as materials covered by AWS Standard D1.1.
 - (1) All stress range cycles shall be below the endurance limit or 10 million cycles, whichever is more stringent.
 - (2) The dynamic load factor shall be determined by the Contractor and shall not be less than $\pm 20\%$.
 - (3) An endurance limit extrapolated from test results shall not be acceptable.
 - (4) An endurance limit calculated using a survival percentage is not acceptable unless explicitly approved by Amtrak, but in no case shall the percent survival be below 97.5 %.
 - vii). A detailed fatigue analysis clearly identifying the endurance limits, allowable fatigue stresses, fatigue stress ranges and load cycle information shall be submitted for review and approval. **[CDRL 6-04]**
 - viii). Fatigue design data such as allowable fatigue stress levels, endurance limits, S-N curve data, MGD characteristics, etc. shall be derived from current versions of nationally accepted standards such as the AAR Manual of Recommended Practices, AWS Standards, American Association of State Highway and Transportation Officials, or other publication that is acceptable to Amtrak.
 - ix). For joint designs not covered by the above (IE spot and laser weld joints), the Contractor shall conduct the fatigue tests necessary to develop the needed design data.
- g). Underframe Structure
 - i). Coupler carrier (if required)
 - (1) The coupler carrier, and those portions of the carbody to which it is attached, shall be designed to withstand the loads caused by supporting one end of the car on the coupler carrier, with the truck attached, such as might occur during emergency jacking or lifting with a crane in the event of a derailment.
 - (2) Under this coupler carrier load, the allowable design stress of the coupler carrier, or any part of the carbody structure to which it is attached, shall be 80% of whichever is lowest of the yield strength, the critical buckling stress or ultimate tensile strength.

- (3) The coupler carrier and its pocket on all car types shall be capable of supporting the conversion of an APTA Type H knuckle coupler or the application of coupler adapter applied.
- (4) Alternate designs may be proposed to Amtrak for approval.
- ii). Body bolster or equivalent structure
 - (1) The design shall provide clearance for the truck in all positions and accessibility for truck maintenance and de-trucking.
 - (2) Positive stops and safety hangers shall be provided between the carbody and the truck to limit the vertical and transverse movement of suspended trucks when the carbody is lifted with trucks attached.
- iii). Cross bearers, floor beams and floor pans
 - (1) No moisture, dirt, dust or debris shall be able to enter into the subfloor for the life of the vehicle.
 - (2) The floorpan, or equivalent structure, shall be designed to facilitate replacement or repair of damaged portions and yet provide the attachment and seal welds required to meet the structural, car pressurization and fire safety requirements.
 - (3) Adhesives shall not be utilized to seal the floor pan or equivalent structure.
 - (4) The cross bearers and floor pans, if used, shall be constructed of stainless materials.
 - (5) The floor pan shall contain the underfloor thermal and acoustic insulation.
 - (6) The pans shall be suitably reinforced for structural rigidity and to prevent resonant noise and vibration and waviness (i.e., oil canning), rippling, and/or buckling under any operating condition.
- iv). Subfloor and floor system.
 - (1) Floors shall be designed and manufactured so that no permanent deformation or soft spots shall occur during the required service life of the vehicle.
 - (2) Floors shall be resistant to spills, washing solutions and moisture.
 - (3) The floor panel system shall be waterproof and resistant to degradation.
 - (4) Floor system panels shall be fully sealed composite panels, as large as practical shall minimize joints in walkways and shall have no joints in the doorways.

- (5) Plymetal floor panels are not permitted.
 - (6) If the floor system is designed to be primary structure, it shall be represented in all tests and analyses.
 - (7) The maintenance manual shall specify the strength and attachment requirements for replaceable elements of the floor system.
 - (8) The number of unique floor panels shall be minimized throughout the vehicle and between vehicles.
 - (9) Under a dead load and a maximum passenger loading of AW3, the floor panels shall deflect by no more than 1/250 of the short span between crossmembers, up to a maximum of 0.0625 in., without permanent deformation.
 - (10) The sub-floor and its attachments to adjacent structural members shall be capable of resisting the shear resulting from the specified compression loading without permanent deformation.
 - (11) The flooring system shall meet 49 CFR 238.103 Fire Safety requirements, utilizing ASTM E119 testing as detailed in Appendix B of the CFR with a minimum fire-endurance rating of 30 minutes at AW3.
 - (12) The representative section of each unique floor assembly configuration shall be reviewed and approved by the Authority but shall be no less than the entire width by 10 feet.
 - (13) All joints shall lie on supporting structure.
 - (14) The floor shall not squeak for the life of the vehicle.
 - (15) Tapping plates for above-floor equipment shall be suitably attached.
 - (16) Carpeting or composite floor covering, where specified, shall be installed per manufacturer's recommendation and shall be approved by Amtrak.
 - (17) Subfloors shall be standardized to the best extent possible and sectioned so that they can be easily replaced in the event of failure.
- h). Collision posts
- i). If CFR 238.211.d will be followed in lieu of other collision post standards and regulations, a documented engineering analysis shall be submitted for review and approval by Amtrak within 30 days of NTP verifying the semi-permanent coupling system and supporting structure is capable of preventing disengagement and telescoping.
 - ii). Analysis and test plan information applicable to the collision post and semi-permanent coupler shall be included.

- iii). Car ends which do not utilize semi-permanent couplers and utilize collision posts to meet telescoping regulations shall meet the following requirements:
 - (1) A continuous cross section shall be fully welded to the bottom and top of the underframe and continue up to at least 18 in and then taper to a point at 30 in or continue to the roof.
 - (2) Longitudinal overload of collision post at 30 in above the underframe resulting in failure along the post shall not cause deformation in the connections to the underframe and its supporting structure. Overload capabilities shall be validated through analysis and testing.
- i). Roof
 - i). General
 - (1) The design loads for equipment and apparatus attached or mounted to the roof, including HVAC units, gutters, air scoops, antennae, lights, equipment supports and supporting roof framing shall meet the carbody strength and fatigue requirements in this Specification.
 - (2) All parts of the roof structure, sheets, equipment covers, roof walkway, screens and other guards shall have sufficient strength to withstand, without exceeding 80% of the yield strength and critical buckling stress under the following conditions:
 - (a) Three concentrated loads of 250 lbs spaced 30 in. apart, each applied over a 3 in. by 3 in. area, such as might be applied by maintenance personnel working on the roof.
 - (b) The placement of the loads shall be such as to produce the worst-case condition for the roof structure without exceeding the yield strength, 80% of ultimate strength and critical buckling meet the rollover strength requirement defined in 49 CFR 238.215.
 - (c) Loads imposed by a mechanical car washer consisting of a pressure of 60 lbs./ft² over a 12 in. wide band extending transversely across the carbody.
 - ii). Emergency roof access
 - (1) Roof emergency access shall be in accordance with 49 CFR 238.123. Perimeter of the cut-zone shall have a retro-reflective sign demarcating the opening, and clearly indicating the purpose, instructions and other emergency signage per APTA Standard PR-PS-S-006-23 and PR-PS-S-002-98.
 - (2) Cross sections of the fully assembled vehicle shall be provided at the emergency roof access locations to validate the entire cut-zone has uniform cutting thickness and the space below is free from all obstructions and secondary structure.

- (3) Configuration of the emergency roof access zone with the roof window layout shall be included. **[CDRL 6-05 CDR] [CDRL 6-06 PDR] [CDRL 6-07 FDR] [CDRL 6-08 FAI]**
 - (4) An emergency egress plan shall also be supplied for each vehicle configuration and shall include a dedicated document with vehicle wide ingress procedure options for emergency responders. **[CDRL6-09]**.
- iii). Gutters and deflecting plates
- (1) Water deflecting gutters shall be installed on the roofline above all door openings on both sides of the car, to 12 in. inward from the end of the door opening or the end of the car as appropriate.
 - (2) They shall prevent water from dripping into or in front of the side door opening, any exterior indicator lights or key switches when the car is stopped.
 - (3) Deflecting plates shall be installed at the ends of the roof of each car to direct water between cars and away from any gangways.
 - (4) The design arrangement and installation of roof equipment shall not permit accumulation of water.
 - (5) If used, drains shall be fabricated from stainless steel and be designed to be inherently protected from clogging (large diameter size, large radii bends, no fittings, large slope, etc.) as a result of debris, leaves, dust, sand or dirt. Drainage provisions must be submitted for approval at the design review.
 - (6) Gutters and deflecting plates shall withstand regular passage through a car wash.
 - (7) Gutters shall be made from the same material as the carbody shell, roof and side sheets.
 - (8) Alternative gutter designs that meet the Specification requirements shall require approval of Amtrak.
- j). Jacking Pads and Lifting Eyes
- i). Jacking pads, with anti-skid plates, shall be provided in approved locations on the side sills to lift the car with trucks attached and fully loaded with supplies and baggage, for maintenance and for re-railing.
 - ii). The car shall be designed to permit jacking or lifting one end of the car for truck removal or re-railing with the other end of the car resting on its truck, without damage to the truck attachments, underframes or any of the underfloor equipment.
 - iii). The Contractor shall coordinate the jacking pad locations with Amtrak so as to permit the use of existing shop permanent jacking systems to the greatest

extent possible. **[CDRL 6-10]** Jacking shall not require any special attachment or removal of components from the carbody.

- iv). Lifting eyes shall also be provided in approved end-of-car locations to lift the car.
- v). If any lifting fittings or adapters are required for connection to the car, 10 sets shall be provided to Amtrak at the time of delivery of the first trainset.
- vi). It shall be possible to lift up a complete car, or either end of a car, utilizing portable jacking devices or a crane and to subsequently support the car with portable stands with truck(s) remaining on the rails and remove the lifting device.
- vii). The truck(s) shall be removable without interference, while the car is supported on jacking pads. All such conditions shall be considered at AW0 without exceeding 80% of yield.
- viii). The localized strength around each of the jacking pads and lifting eyes shall be designed for a vertical load of one half the weight of the car at AW0 (including trucks) with a horizontal load of 10% of the vertical load.
- ix). The horizontal load shall be applied simultaneously with the vertical load in any direction to produce the worst stress condition.
- x). The allowable design stress shall be yield or 80% of ultimate, whichever is lower or the critical buckling stress of any part of the lifting location or the structure to which it is attached.
- xi). The empty carbody, with trucks attached (AW0), shall be capable of being lifted on any symmetric lifting eyes or jacking pads without exceeding 80% yield.
- xii). The empty carbody, with trucks attached (AW0), shall be capable of being lifted on the outboard most diagonally opposite jack pads or lifting eyes without exceeding 80% of yield.
- xiii). Analysis of the carbody structure under torsional loading of all diagonal jacking and diagonal lifting cases, and all symmetric lifting and jacking cases, shall be included in the stress analysis.

6.5 Truck to Carbody Interface

- a). The carbody stress analysis must assess the carbody's compliance with the truck-to-carbody connection criteria detailed in Chapter 7.
- b). This assessment shall use the reaction loads derived from the truck-to-carbody connection evaluation presented in Chapter 7.

6.6 Doorways and Passageways.

- a). Refer to Chapter 12.

6.7 Gangway

- a). At all car ends of the trainset, a weathertight bellows shall be provided completely enclosing the doorway between cars, including the space below the doorway.
- b). It shall provide a safe, stable, weather resistant passageway between two coupled cars which meets or exceeds all ADA requirements for wheelchair passage and target a 40" wide opening as much as practical.
- c). The design shall also permit trainset wheeled catering carts, as well as wheeled passenger baggage, to easily pass through the cars.
- d). The maximum variation in walking surface height when passing between cars, from vestibule to vestibule, shall not exceed the ADA threshold limit of 0.5 inch, but should be minimized.
- e). Tripping hazards and pinch points shall be eliminated by design.
- f). Passenger vertical handrails shall be provided on both sides of the passageway.
- g). The passageway shall exclude water ingress within the clearway of gangway system, shall exclude drafts under all normal operating conditions, and shall have a minimum design life of 16 years.
- h). Any wear surfaces shall have a design life of no less than 8 years.
- i). The design shall have no metal to metal contact between moving parts, in order to prevent noise, minimize wear between all parts, and require no lubrication.
- j). The walkway plates, buffer and side stems shall be so designed to permit coupled cars to negotiate minimum radius curves and crossovers, without any binding of the mechanism.
- k). The passageway arrangement and installation shall be identical at all intermediate car ends, to easily allow changes in trainset consist configuration, and is subject to approval by Amtrak during design review.
- l). The inter-car bellows shall be mounted so as to easily allow its disconnection from the end of the car(s) to allow access to lifting eyes in Section 6.4.j). for lifting derailed cars in an emergency.
- m). The outer end of the coach trainset shall be equipped with a semi-permanent weathertight end wall cover.
- n). All exposed components shall be stainless steel including all mounting hardware. The end wall cover shall have a design life of minimum 10 years.
- o). The gangway shall be capable of self-supporting when disconnected from either end so that when coupling, a jack is not required to recouple.
- p). To the largest extent practicable, car to car trainlines shall be protected within the gangway to protect against the elements and debris strikes.

6.8 Elevators, Lifts and Food Service Lifts

a). Overview

- i). This section describes the design and functionality of the various passenger and materials lifts necessary to support Long Distance Trainset operations.
- ii). Accessible passenger must be given access to amenities or features on upper levels of cars which require stairs for able body passengers.
- iii). In addition, Amtrak personnel must have access to lifts necessary to move serving carts and meal trays between levels of multi-level cars.
- iv). For the purposes of this section the term Lift may be used as a generic term for all systems specified in this section.
- v). Four types of lifts are required for service:
 - (1) Accessibility Lift utilized to facilitate boarding of accessible passengers between platform and cars.
 - (2) Elevator for moving accessible passengers between levels of multi-level cars.
 - (3) Cart Lift for moving serving carts between levels of multi-level cars
 - (4) Food service lift for moving serving trays between the levels of the café car.
- vi). Refer to Chapter 11 and 16 for the passenger interface details of these features.
- vii). Structural connections for lifts, elevators and food service lifts shall be evaluated in parallel with the carbody stress analysis and at a minimum include conclusions within the carbody stress analysis report.

b). General Requirements

- i). All Lifts and associated equipment shall be suitable for sustained operation under all ambient conditions through which these cars are expected to operate (see Chapter 1).
- ii). Controls for each Lift shall be adjacent to the Lift they control.
- iii). The Accessibility Lift controls shall allow a train crewmember to readily supervise all aspects of the lift operation and movements of the wheelchair occupant to/from the lift without obstructing or impacting the occupant's movements for the Accessibility Lifts.
- iv). Accessibility Lifts shall be included on each accessible coach and accessible sleeper cars.

- v). Accessibility Lifts on bi-level cars shall be sized for moving passengers from low level platforms to the boarding door on the lower level.
 - (1) Low level station platforms may be either below Top of Rail, at Top of Rail, 8 inches above Top of Rail and 61 inches from centerline of track, or 15 inches above Top of Rail and 64 inches from centerline of track.
 - (2) At station platforms not owned by Amtrak, the depth of the platform may vary creating concern with on-board mobility device lifts.
 - (3) Contractor must account for these variations in platform depths in the design of the on-board mobility device lift.
- vi). Accessibility Lifts shall be interlocked with the vehicle braking system so that train movement is prohibited with the lift deployed.
- vii). When not in operation the Accessibility Lifts shall be stowed in such a manner to not inhibit passenger movements.
- viii). Accessibility Lifts shall be capable of lifting 800 lbs (363 kg).
- ix). Elevator shall be included on each multi-level accessible coach and accessible sleeper car.
- x). Cart Lift shall be included on bi-level coach cars to facilitate movement of Amtrak approved service carts between floors.
- xi). Cart Lift shall be sized for movement of one/two carts with sufficient vertical clearance for service materials placed on the cart top may remain in place during floor transfer.
- xii). Access doors shall be locked at top and bottom of cart lift space such that Amtrak employees have the only access to the cart lift. Usage of Amtrak coach key /keycard is required to open either door.
- xiii). Cart Lift operation shall be available at any time during service operation.
- xiv). Cart Lift shall include an interlock to prevent movement unless both cart lift doors are locked.
- xv). Food service lift shall be provided on the café car to facilitate the movement of service trays and bussing tubs between the food service area and the kitchen below.
- xvi). Food service lift shall be capable of moving 4 serving trays with plated food, dish covers and associated materials or a fully loaded bussing tub.
- xvii). The Food service lift upper level access door shall be include locking feature using the Amtrak coach key /keycard. The lower door shall include a hand operated latch function to secure the door.

- xviii). Cart Lift and Food service lift operation shall be available at any time during service operation.
 - xix). Food service lift shall include an interlock to prevent movement unless both doors are closed.
 - xx). Accessibility Lifts. Elevators, Cart Lifts and Food service lifts shall be designed so that any failed component can be easily removed from the car at using the end doors or lower level vestibule doors.
 - xxi). Contractors shall make every attempt to standardize components between lift types.
- c). Structural Requirements
- i). All lifts shall be secured to the car structure in a manner such that twist, roll or flexing of the shell shall not affect lift operation.
 - ii). Lift tracks or guide rails shall not be distorted by carbody or vehicle movement to prevent operation. Clearance between car structure and lift tracks can be developed as needed for design however any bridging between lift platform and car floor shall be automatic.
- d). Accessibility Lift Requirements
- i). Two Accessibility Lifts shall be provided on the identified cars, mounted on opposite sides of the same vestibule space.
 - ii). Lift operation may be a combination of manual and automatic features. Manual actions to deploy or stow the lift shall be accomplishable by a 5th percentile female.
 - iii). Lift controls shall be in the vestibule space and shall require an Amtrak standard coach key to enable.
 - iv). Amtrak is open to alternate designs that may eliminate the need for an accessibility lift on the vehicles. The car builder can propose an alternate design so long as the access to the vehicle from the platform is within compliance of ADA requirements
- e). Emergency Operation
- i). In the event of a loss of power the Accessibility Lift shall include manual operation provisions to allow passengers to be moved between the car floor and platform.
 - ii). Manual operation shall allow for continuous operation to move multiple passengers as needed.
 - iii). Manual deployment, lift and lower operations shall be limited to a maximum of 50 lbs for any individual task.

- iv). The lowest station platform height for the purposes of the lift's upper and lower reach shall be assumed to be the top of rail.
 - v). The lift design shall also allow for operation when the car is on a curve with up to 7 in. of lean, due to super-elevation.
 - vi). The lift shall be of modular, compact design to facilitate removal and replacement for servicing/repair.
 - vii). Under power operation, the complete cycle of deploying the platform, lowering the lift to platform height, raising the lift to car floor height and stowing the lift platform shall require no more than between 30 and 60 seconds.
 - viii). The lift shall comply with the most recent RVAAC recommendations and any applicable ADA standards.
- f). Cart Lift
- i). Carts shall be rolled in and rolled out of the lift through door openings.
 - ii). The entire Cart Lift shaft system shall be fully enclosed.
 - iii). Upper and lower level access points shall be controlled using an Amtrak Coach key unless cart lift station is behind existing access controlled spaces.
 - iv). The Cart lift shall be powered by cars 72VDC bus.
 - v). The Cart Lift shall be capable of lifting 600 lbs (273 kg).
- g). Food service lift
- i). The entire Food service lift shaft system shall be fully enclosed.
 - ii). All surfaces of the lift shall be stainless steel or alternate material with anti-microbial coatings as approved by Amtrak.
 - iii). The Food Service lift shall be powered by cars 72VDC bus.
 - iv). The Food Service Lift shall be capable of lifting 700 lbs (318 kg).
- h). Manual Operation
- i). It shall be possible to manually raise and lower the elevator in an emergency situation where the elevator mechanism fails or if power is not available to the elevators. The mechanism needs to be submitted for review and approval by Amtrak.

6.9 Safety Appliances

- a). Exterior

- i). Railroad safety appliances shall be provided to each car of the trainset in accordance with 49 CFR Parts 229, 231 and 238, and APTA Standard PR-M-S-016-06.
 - ii). An ergonomic evaluation shall be performed by the Contractor and approved by the Engineer regarding the size, placement, and positioning of all safety appliances, especially loop step arrangement and necessary handholds.
[CDRL 6-11]
 - iii). The Contractor is requested to recommend improvements which facilitate train crew and maintenance personnel boarding and detraining.
 - iv). Handholds shall be 0.625 inch diameter one piece forged stainless steel and attached with stainless steel bolts or rivets.
 - v). The Contractor shall arrange for an FRA sample car inspection of the safety appliance applications and shall provide Amtrak with a copy of the FRA “no exceptions taken” letter prior to release of the first equipment of each type.
[CDRL 6-12]
- b). Interior Passenger Handholds
- i). ADA compliant passenger handholds shall be provided throughout the cars for safety, and in particular as follows:
 - (1) At each side entrance doorway to allow use during the entire boarding and alighting process; and
 - (2) On both sides of the passageway adjacent to the gangway;
 - (3) On both sides of the interior stairwell; and
 - (4) Additional handholds shall be provided in the passenger compartment for standing passengers and in the Food service areas. The quantity and location of handholds will be reviewed during design review. See Chapters 11 and 16 for additional details.

6.10 Equipment, Equipment Boxes, Equipment Rooms and Access Doors

- a). General
- i). The nature of the long distance service intended for the trainsets will require a high degree of protection from foreign object damage, and from the effects of winter weather conditions.
 - ii). Areas above the trucks, below the upper levels shall be utilized as equipment storage for HVAC units, water and waste components, batteries and any other large sub-assemblies which cannot be fitted within the passenger interiors.

- iii). These equipment rooms shall be protected from water intrusion and debris strikes and provisions shall be made by insulation or air conditioning/heating to avoid freeze damage or overheating.
 - iv). Large assemblies within these equipment rooms shall be stored on pallets for ease of replacement.
 - v). Pallets shall have forklift receivers for lifting, installation and removal without special tools or adapters.
 - vi). The pallets shall be fastened to the carbody so that there is no movement or noise under normal operation.
 - vii). All connections and fasteners maintenance must be feasible from the sidewall opening and not require the worker to crawl inside the compartment.
 - viii). The equipment rooms shall be provided with sufficient lighting for on board maintenance, see Chapter 13 for additional details.
 - ix). A small, separate set of hinged covers shall be provided on each side of the car for the water tank fill points, and the waste tank drain hose/control valve access points, so as to not require the full side access covers to be opened for their servicing.
 - x). Undercar components requiring actuation and/or daily or routine maintenance must be readily and easily accessible.
 - xi). All equipment boxes, which are required to be watertight, shall be given a water test. Junction boxes are required to be watertight.
 - xii). The interior of all electrical equipment boxes and terminal boxes shall be primed and shall be given one coat of white insulating coating.
 - xiii). A single coat of insulating varnish, enamel or white (or approved color) epoxy powder coating may also be used. Insulating coatings are not required on fiberglass surfaces.
 - xiv). Final dimensions, arrangement of all equipment compartment access points and attachments to the carbody shall be subject to approval by Amtrak.
[CDRL 6-13]
- b). Carbody Attachment
- i). Brackets and other means of support for the equipment shall be designed and installed to facilitate access for maintenance and servicing and for removal and re-application.
 - ii). Fasteners shall be conveniently accessible.
 - iii). The attachment of all apparatus over 150 pounds to the carbody shall be in accordance with APTA Standard PR-CS-S-034 Section 2.7.

- iv). Interior fittings shall be in accordance with 49 CFR 238.233 and APTA Standard PR-CS-S-006.
 - v). In no case shall the strength of a fastener or the shearing of the fastener through the base material be the limit of the carrying capacity of a member.
 - vi). Improperly torqued fasteners could result in nuts becoming loose consequentially developing an improper mating with the hardware.
 - vii). As result, an analysis of all the attachments for loose bolts should be considered.
 - viii). The analysis of the connection shall include considerations for fastener shear, pull out, and fastener tension.
 - ix). Equipment supported on resilient mounts shall always be designed to have the resilient mount in compression and have safety straps or other devices that will support it in case of a failure of the resilient mounts.
 - x). The design of the safety straps shall include the effect of the equipment dropping from its mounts.
 - xi). Under no circumstances shall equipment be supported by bolts in holes that are tapped into the primary structure of the end underframe.
 - xii). The following shall apply to apparatus over 25 pounds:
 - (1) Vertically oriented bolts shall not be the primary vertical load-bearing mechanism.
 - (2) Bolted connections shall be designed with a factor of safety of 1.5 using bolts of not less than 0.375 of an inch diameter when analyzed for in-service loads.
 - (3) No bolts in tension may be utilized.
 - (4) All bolted connections in equipment supports shall be supplied with minimum SAE J429 Grade 5 bolts or equivalent, plated for corrosion resistance in accordance with Chapter 19. Alternatively, metric fasteners of at least M10 property class 8.8 or A4-80 may be used.
- c). Floor and Roof Penetrations
- i). The Contractor shall ensure that all floor and roof penetrations shall be sealed against fire, pressure differential and entry of vermin and provide for a watertight and dust tight carbody.
 - ii). Floor penetrations shall be sealed with an appropriate material to prevent flame propagation from underfloor flame sources; and shall last the life of the car.

- iii). Considerations shall be made for compliance to ASTM E119 for representative floor penetrations.
- iv). Full interior to exterior floor penetrations shall be made through sealed tubes to prevent moisture from entering pan to floor area.
- d). Battery Box
 - i). See Chapter 15.
- e). Electrical Connections
 - i). Enclosures which, because of internal layout and/or limited external access, require removal from the car for mid-life overhaul shall have electrical connections made by the use of connectors meeting the requirements outlined in this Specification.
 - ii). The connectors shall lie within the enclosure, and the cables shall enter the enclosure through watertight fittings.
 - iii). Fully enclosed cable ducts or conduits shall not connect directly to such enclosures but shall incorporate a flexible or rigid, detachable transition piece that will facilitate breaking the connection.
 - iv). Other enclosures shall have cables and wires entering the box through watertight fittings and shall terminate on devices, bus bars, terminal blocks, etc.
- f). Covers
 - i). Maintainability and accessibility shall be the driving criteria in designing the layout of the equipment bay.
 - ii). Equipment rooms shall be sufficiently protected from exterior, subject to review and approval by Amtrak.
 - iii). Equipment that needs routine maintenance and inspection shall be accessible without the need for dismounting access doors and panels. Enclosure openings shall be sufficiently large to permit easy removal and replacement of all components in that area.
 - iv). The Builder shall design the layout taking into account the frequency of inspection, service and overhaul requirements of individual systems within the equipment rooms.
 - v). The concept and design of the equipment rooms shall be subject of early design review, including but not limited to the following subjects:
 - (1) Safety: security of the enclosure to unintentional opening and/or displacement of panels & doors

- (2) How the end shields are “hardened” against damage and yet easily replaceable
- (3) Impact of access to undercar mounted equipment
- (4) How the design interfaces with major system components for ease of installation/removal, especially: waste tank, air brake manifold, battery
- vi). Equipment room doors shall open 180 degrees for quick examination of the interior.
- vii). All hinged covers shall also be readily removable.
- viii). Openings provided upon removal of covers shall be of sufficient size to permit removal and replacement of any component in the room and easy access to equipment in the room for inspection and maintenance.
- ix). All covers shall have a permanently attached fail proof mechanism for locking in the open position.
- x). The “hold open” feature shall in no way interfere with or impede the easy removal or replacement of the door.
- xi). The doors shall be designed to be lightweight and readily repairable at Amtrak facilities in the event of debris strikes.
- xii). Door panels shall be operable by a single person, requiring no more than 10 lbs. of force to open, secure open, or close.
- xiii). Doors shall be designed to be standardized sizes across the entire fleet.
- xiv). Doors shall be designed so that components or systems requiring daily or routine maintenance are readily and easily accessible.
- xv). All latches that must be manipulated to gain entrance to the enclosures shall be quick-release, spring loaded latches which operate with a toggling-type action.
- xvi). Latches must be recessed or have a safety lock which will prevent accidental activation.
- xvii). All latches shall be of the highest quality, designed for heavy-duty railroad service and applied in sufficient number to ensure adequate gasket compression needed for long term watertight quality sealing.
- xviii). Adequate clearances for all handholds, latches, etc., shall be provided so that a person wearing gloves in a winter environment is not hindered.
- xix). All doors shall fit well and be adequately gasketed where necessary to prevent the entrance of water (including both a driving rain and a high pressure car wash spray), dust and snow.

- xx). All gaskets shall remain intact for a period of at least 10 years.
- xxi). Only one common type of gasket shall be used on all doors using a positive mechanical means of attachment.
- xxii). Flat foam strips or glue-on attachments shall not be permitted.
- xxiii). The design shall allow for ease of gasket replacement, without use of adhesives.

6.11 Windows

a). General

- i). Frame and glazing rubber of side passenger windows and side door windows shall be designed to securely retain the glazing material under all operating conditions on specified track configurations.
- ii). Glazing assembly (frame, rubber and glazing material) shall not leak during carbody water tests and shall not rely on sealant.
- iii). The glazing material shall show no physical damage or degradation of optical qualities when exposed to the environment encountered in rail passenger service.
- iv). All glazing assemblies shall meet all applicable requirements of 49 CFR Parts 223 and 238 for FRA Tier I service. They shall meet any applicable APTA requirements.
- v). The Contractor may propose as an alternate design the deletion of the restroom side window for Amtrak approval.
- vi). Material selection for glazing rubber and all other materials in all locations must take into account the possible interaction between the materials as well as the environment.
- vii). The design of all glazing shall be approved by Amtrak. **[CDRL 6-14]**

b). Glazing Materials

- i). Glazing material shall be polycarbonate and shall conform to the requirements specified in Chapter 19.
- ii). Only flat glazing shall be used.
- iii). The passenger area and restroom side windows shall be double glazed units.
- iv). All door, sign and interior partition windows shall be single glazed units.

- v). Material shall be integrally tinted with no appreciable variation in color over the entire area of each glazing and between panel of like color designation and thickness.
 - vi). Color measurements shall be taken with a spectrometer.
 - vii). All glazing materials shall be coated on both sides with a UV protective, anti-scratch, anti-graffiti film.
 - viii). Film selection shall be submitted to Amtrak for review and approval.
 - ix). Markings are to be in accordance with current ANSI Standard Z26.1 and 49 CFR Part 223.
 - x). Location of these markings must be visible for identification after installation.
- c). Side Windows
- i). General
 - (1) Side windows shall be polycarbonate, double glaze, certified FRA Type II, and conform to the requirements specified in Chapter 19.
 - (2) The edges of the unit shall be sealed.
 - (3) Retention of glazing material shall allow installation and/or removal of the main rubber extrusion from the carbody frame.
 - (4) The window opening in the carbody shall be as large as practical and reinforced to keep the opening flat.
 - (5) A leak-proof seal shall be provided.
 - (6) The use of sealants or adhesives is prohibited to achieve a watertight seal.
 - ii). Coach Car Side Windows
 - (1) Coach cars shall have consistent spacing of large windows with equal pitch for passengers' viewing pleasure and to serve the dual purpose of emergency egress.
 - (2) Coach windows size and spacing shall be designed to aid in minimizing the number of carshell types and ensuring that all seating positions and accessible spaces have a view out of the window.
 - (3) Windows shall be at least 24" x 26" in accordance with 49 CFR 238.113; however, the largest window size that can be removed without obstruction should be used.
- d). Skylight Windows

- i). Skylight windows shall be included in the offering from the Contractor for Amtrak to exercise as an option.
 - ii). Passenger visibility shall be maximized through the use of flat glazing as large as practical considering maintenance practices for weight and support methods for maintenance personnel, this point shall be discussed in design review.
 - (1) This shall be achieved by incorporating an upper row of windows aligned above the roof rail.
 - (2) Skylight windows shall be mounted at an angle on the roof of the car.
 - (3) Alternatively, a window arrangement with a better viewing field can be proposed for Amtrak review and approval.
 - iii). Skylight windows shall line up with the coach sidewall windows on the upper level of the car and will be of the same width along the car.
 - iv). The depth that the window extends inward along the roof of the car shall be determined by the Contractor but shall be no less than 26" x 24" so that the skylight window can provide emergency roof access according to 49 CFR 238.123 as a rescue access window according to 49 CFR 238.114.
 - v). To the extent practical, the gap between the upper and lower window rows should be reduced to the bare minimum and positioned at the highest point.
 - vi). The viewing field along the length of the vehicle shall be optimized by reducing structural and interior obstructions for the windows, i.e., the thickness/depth of the posts and interior panels should be minimized so the glazing is flush with the structure and interior to the maximum extent practical.
 - vii). Skylight windows shall be easily replaceable by maintenance staff while providing a design preventing from leaks. Design shall be focused on providing a controlled drainage path to prevent accumulation of liquids and to not collect in any area which would result in leaks to the interior or corrosion of components.
- e). Emergency Side Windows
- i). All windows on this fleet shall be arranged as emergency windows.
 - ii). A two part "Emergency" handle that wraps the window edge shall be provided at all windows for removal of the window from inside of the car.
 - iii). The design of the glazing rubber shall also allow removal of the glazing from the outside of the car by emergency responders as described below.
 - iv). The pull force to remove an emergency side window shall be less than 25 lbf.

- v). Emergency windows shall be provided and identified in accordance with 49 CFR Part 238.
 - vi). Identification and removal instructions shall be provided in accordance with 49 CFR Part 223, 49 CFR Part 238.113, 49 CFR Part 238.114, 49 CFR 238.125, APTA Standard PR-PS-S-002-98, and ASTM Standard D 4956-07 for Type I material sheeting.
 - vii). The Contractor shall consider methods for the retention of windows in their frames in the event of an accident.
- f). Rescue access windows
- i). All side windows shall be rescue access windows and shall be capable of being removed from the outside of the car by prying and pulling a “zip-strip”.
 - ii). Rescue access windows shall provide a means of rescue access by emergency personnel such as, police, fire department, etc.
 - iii). Emergency side windows on each side of the car shall be designated as an emergency and rescue access – dual-function window.
 - iv). Identification and removal instructions shall be provided in accordance with 49 CFR Part 223, 49 CFR Part 238.114, APTA Standard PR-PS-S-002-98, and ASTM Standard D 4956-07 for Type I material sheeting.
- g). Door Windows
- i). All door windows (such as the side door, end car collision post door and sliding interior door). The side door window dimensions shall permit a standing train crew member to clearly see out of the window.
 - ii). The end car collision post door shall be clear and meet the requirements for FRA Type I glazing.
 - iii). The side door windows shall be tinted and meet the requirements for FRA Type II glazing.
 - iv). The sliding interior door window shall be clear and meet the requirements for FRA Type II glazing.
- h). Exterior Destination Sign Windows
- i). Each exterior destination sign shall have a flat piece of FRA Type II non-tinted window glazing, of sufficient size to prevent masking the display.
 - ii). The glazing shall be resistant to any defrosting heat which may be applied.

6.12 Insulation

- a). Acoustical Insulation

- i). To reduce movement, structurally-borne sound and noise generated by the vibration of the roof, floor and side sheets, panels, air conditioning ducts and other metal surfaces, in particular the doors, damping material shall be applied to the inner side of these surfaces where necessary.
 - ii). The thickness of the damping material shall be such that it shall provide ten percent of critical damping for the treated surface.
 - iii). The damping material shall have a vibration decay rate of not less than 35 decibels per second (dB/sec) as measured by the Geiger-Hamme Thick Plate Test Method.
 - iv). The damping material shall have a hydrodynamically smooth finish and shall be receptive to painting.
 - v). It shall be resistant to dilute acids, alkalis, greases, gasoline, aliphatic oils and vermin.
 - vi). It shall be unaffected by sunlight or ozone and shall not become brittle with age.
 - vii). The material shall not contain any asbestos and shall meet the flammability and smoke emission requirements of Chapter 19.
 - viii). Its application shall be according to the supplier's recommendations and shall include an application of a recommended primer.
 - ix). The sound dampener shall be compatible with the material used at the affected locations in the car structure.
 - x). The inner surface of the carbody structural shell, except for the end underframe welds, shall be coated, and the inside surfaces of structural members sprayed to the extent necessary.
 - xi). Structural members under the floor of the carbody shall not be coated.
 - xii). The outside or inside surfaces of the main air duct, and all ventilation cross ducts shall be treated with acoustic insulation to reduce noise.
 - xiii). Duct splitters (if used), the underside of the main air duct, top/bottom of floor beams and inside door pockets shall not be coated.
- b). Thermal Insulation
- i). The heat transfer through the carbody, using only the carbody's own floor heaters, shall not exceed 14 Btu/Hr/°F per foot of car length (derived from 1200 Btu/Hr/°F for an 85 ft car) under the environmental conditions specified in Amtrak Specification 963 while the carbody is stationary. Other values may be proposed to Amtrak for consideration.
 - ii). Glass wool or fiberglass insulation shall be used.

- iii). The use of urethane foam insulation is prohibited.
- iv). All insulation used shall not mold, rot, have any odor, corrode any metals, nor shake down in long service under vibrating conditions.
- v). The heat transfer capabilities shall not diminish over the life of the vehicle.
- vi). The Contractor shall supply a thermal analysis of completed car for approval at the design review.
- vii). A vapor barrier shall be provided between all interior linings and the carbody insulation.
- viii). There shall be no all-metal path between interior of the carbody and outside of the carbody skin.

6.13 Exterior Finish

a). General

- i). The exterior finish of the vehicle shall maintain its appearance with regular maintenance.
- ii). Soon after fabrication, all non-weathering carbon steel portions of the carbody shall be prepared for painting and immediately thereafter painted with the first coat of primer by trained technicians utilizing the paint supplier's written procedures.
- iii). Stainless steel shall not be painted, but shall be sufficiently passivated after assembly, and no signs of rusting at welds or along any portion of the exterior shall be allowed.
- iv). The surface preparation and graphics applications shall ensure that the car can operate at least eight (8) years between major exterior finish repairs or replacement.
- v). All exterior surface treatment plans and specifications shall be submitted to Amtrak for review and approval. **[CDRL 6-15]**
- vi). All paint shall include, at a minimum, a primer coat, color coat and clear coat, applied in accordance with manufacturer specifications.

b). Painting - Exterior

- i). Care in painting application shall ensure freedom from runs, sags, orange peel and other unsightly paint deficiencies, by trained technicians utilizing the paint supplier's written procedures.
- ii). Exterior designs shall be approved by Amtrak during Design Reviews.
- iii). Paint system is subject to approval by Amtrak for its corrosion protection and aesthetic durability.

- iv). The paint system must allow for at least twelve years of durability.
- v). Replacement of decals shall withstand a minimum of eight years and not damage the paint surface during removal.
- vi). Paint system shall meet Amtrak Specification 742-1.

6.14 Graphics and Labels

a). Exterior Graphics

- i). All exterior graphics, lettering and signage, including vehicle numbers and reporting marks, shall be applied to the vehicle in accordance with
- ii). Amtrak specifications as identified by Amtrak during design review.
- iii). The Contractor may request minor modifications to the size, location and placement of decals, striping and paint application in order to accommodate carshell features, equipment, maintenance points or other obstructions that will affect the quality, appearance or longevity of the decals or graphics.
- iv). All exterior decals shall be retro-reflective unless specified otherwise.
- v). All decals, graphics and signage shall be specified and designed to function in the operational, environmental and climatic conditions specified in Amtrak specification 963 with no fading, material degradation, delamination, discoloration, shrinkage or expansion, wrinkling or peeling.
- vi). It is the expectation of Amtrak that the exterior livery would be jointly developed by the Contractor and Amtrak.
- vii). It would be expected to be a final design of vinyl material that allows for the wrapping of all exposed stainless steel surfaces of the carbody including the roof, end sheets and any undercar elements including but not limited to shrouds.
- viii). Each mock-up shall have a vinyl wrapped exterior livery for further input on the design direction.

b). Labels

- i). Exterior equipment shall be labeled in accordance with Amtrak Specification 696. Emergency-related decals and signage shall conform to all applicable APTA standards and FRA requirements.

6.15 Automatic Equipment Identification (AEI) Tags

- a). Each car shall be equipped with an Automatic Equipment Identification (AEI) transponder tag on each side, located in conformance with Universal Machine Language Equipment Register (UMLER) dimensional and securement requirements and programmed with the reporting marks of the owner, road number of the vehicle and all other technical data required by UMLER.

- b). The Contractor is responsible for ensuring the following:
 - i). Tags are properly installed in accordance with UMLER requirements;
 - ii). Tags are properly programmed with all data required by UMLER; and
 - iii). The UMLER/EMIS system is updated with the data for each vehicle as required for shipment.

6.16 Stress Analyses

- a). Stress Analyses and Test Plan
 - i). A stress analysis and test plan for the carbody structure shall be submitted for approval no later than 120 days after NTP. **[CDRL 6-16]**
 - ii). Separate plans shall be prepared for each car type in the trainset as required.
 - iii). The Plan shall address the requirements of this specification, any applicable CFR, and the latest APTA Standard PR-CS-S-034-99.
 - iv). The Stress Analysis and Test Plan shall be discussed during the first design review meeting.
 - v). Each Plan shall be a working document and updated as the design develops.
 - vi). When the plan for the analyses and testing is revised, it shall be updated and resubmitted no more frequently than monthly.
 - vii). Each revision shall include revision level indications.
 - viii). The stress analyses and tests plan shall be approved prior to submittal of the stress analysis report required by this Specification.
 - ix). The Plan shall be made a volume of the stress analysis report.
 - x). The Plan shall follow the general requirements of the report as identified herein.
 - xi). A master table of all different carbody types and their applicable car types for the entire project shall be provided in each plan.
 - xii). Carbody types utilizing an analysis or test from a different carbody type for validation shall clearly reference it in the plan.
 - xiii). Carbodies which utilize different drawing or part numbers because of small differences that utilize the same validation analysis or test shall include thorough design differences comparisons in the design review package.

- xiv). The Stress Analyses and Test Plan shall detail the methods and approach that will be used to analyze and test the carbody and truck.
 - xv). It shall also include the following, with references to standards and publications as appropriate:
 - (1) A comprehensive table of material properties detailing the engineering properties of each grade and temper used in the carbody.
 - (a) This table shall include the FEA material property inputs and literature references or testing reports supporting these selections.
 - (2) Detailed and high-resolution illustrations of each material's respective locations.
 - (3) A numbered listing of each load condition for analysis and test, including load magnitudes and points of application, with CFR, APTA, and Specification references.
 - (4) Acceptance criteria for each load condition.
 - (5) Diagrams displaying loads applied and points of support for each load condition for analysis and for testing.
 - (6) A description of the software settings, model setup, and meshing quality assurance.
 - (7) Description and examples of methods for analyzing and evaluating the critical structural connections for static and fatigue (all major joint types shall be included; IE resistant and laser welding). Examples should include partial penetration welds if used (IE resistant and laser welding).
 - (8) Fatigue joint testing plan for joint designs not covered by AAR or AWS.
 - (9) Descriptions and examples of methods used in past projects to evaluate and justify stress singularities and stress concentrations in the FEA results.
 - (10) Table of all interior fittings to be analyzed and vehicle equipment over 150 lbs shall be provided with their respective mass and locations.
 - (11) Description of structural manufacturing work done outside the Contractors main manufacturing facility.
 - (12) If applicable, description of design process for dissimilar metal connections to isolate and prevent any galvanic reactions.
- b). Road Test

- i). The life expectancy of the assembled car shall be validated for 40 years by evaluating the carbody's stresses during a road test of representative track (i.e. possibly the ride quality or truck stability testing).
 - (1) The data shall be used to calculate a resultant accumulative damage in the material and projected out to 40 years.
 - (2) The total damage shall be compared to the materials tested fatigue life.
 - (3) A comparison should also be made to the selected dynamic factor and resultant stresses from the fatigue analysis.
 - (4) A minimum of 20 locations on the carshell shall be strain gauged and with a triaxial accelerometer on each body bolster and truck.

- c). Finite Element Models
 - i). The Contractor shall submit electronic copies of the preliminary and final Finite Element (FE) models for review by Amtrak. **[CDRL 6-17 PDR] [CDRL 6-18 FDR] [CDRL 6-19 FAI]**
 - (1) The formats and which major loading results shall be agreed upon between the Contractor and Amtrak.
 - ii). As part of the carbody FAI, the Contractor shall provide reports, models, illustrations, and drawings for the Authority to audit and verify the final FEA model represents the final condition of the carbody structure.
 - iii). If the FEA model does not represent the final condition of the carbody structure such as welds or holes to accommodate interfacing sub-systems, these differences shall be summarized and justified.
 - iv). Car types claiming to use the same carbody structure shall be similarly validated.
 - v). The FEA model shall include the major structural components of the:
 - (1) stairways between levels
 - (2) lifts, elevators, and food service lifts, and
 - (3) HVAC if not resiliently mounted.
 - vi). Other major equipment which adds considerable stiffness to the carshell may be required at the Authority's discretion.

- d). Carbody Stress Analyses
 - i). The stress analysis shall show the calculated and allowable stresses and margins of safety for all elements, for all specified load conditions, and shall

include calculations of stresses in joints, joint elements, and other important elements.

- (1) It shall include FEA results, connection, buckling, natural frequency and fatigue analyses.
- ii). Preliminary stress analysis results shall be prepared and submitted for review and approval not later than 60 calendar days after approval of the analysis and test plan **[CDRL 6-20]**.
- (1) Preliminary results of all load cases shall be included.
 - (2) The formats shall be agreed upon between the Contractor and Amtrak. **[CDRL 6-21, PDR]**
- iii). The stress analysis report shall be prepared and submitted for review and shall be fully approved prior to commencing manufacture of any carbody structural parts. **[CDRL 6-22, FDR]**
- (1) The Contractor shall submit the required stress analysis report in compliance with the format and content specified herein.
 - (2) If a cited reference in the report is not readily available to Amtrak, the Contractor shall provide the reference or copies of the pertinent pages.
 - (3) All references shall be in English.
 - (a) If an English language reference is not available, an English translation shall be provided, and both the original and the translation shall be included in the report.
 - (4) The report shall demonstrate that all structural members satisfy the requirements of the FRA, APTA and this Specification for compliance with each design load and condition and represent good design practice in the North American railroad industry.
 - (5) The report shall be organized and in sufficient detail so that Amtrak can readily follow the theory and its application to the car.
 - (6) The Contractor shall certify that the analysis and calculations have been reviewed and validated before the report is submitted to Amtrak.
 - (7) If tests are conducted to provide the necessary data, the entire test report shall be submitted.
 - (8) This report shall show the test procedure, raw data as well as reduced data, and summary, with detailed discussion of the results.
 - (9) The report shall include analyses of all critical connections and summarize the connections in a critical weld list.

- iv). Critical connections which cannot be adequately analyzed shall be prototyped and tested to demonstrate compliance with the requirements of the design and the Specification.
- v). The FEA shall be supplemented as necessary by manual or computer calculations of stresses at joints.
- e). Validation of Stress Analyses
 - i). Validation of the finite element model shall be accomplished by comparing the carbody structural test results for each test required by Chapter 20 with the corresponding stress analysis results.
 - (1) This information shall be tabulated and submitted with the carbody structural test reports for each test. **[CDRL 6-23]**
 - ii). In the test procedure for each test to be used for validation, there shall be a pre-selected list of strain gauges to be used for the comparison, which shall not be less than half of the total number of strain gauges used during the test.
 - (1) This table shall include gauge number, type, element number, general location, stress analysis strain value in the active direction of the gauge, active direction of gauge on carbody, a column for the strain gauge value, and a column for notes.
 - (2) For rosette strain gauges, the information above must be supplied for each leg as well as the combined result.
 - iii). The test report shall include tables that compare stresses calculated from the test strain gauge readings with analytical stresses from the FEA and shall include the test stress value, the analytical stress value, the percent difference between the two values, and a space for annotation.
 - (1) The report shall include a graph plotted using commercially available spreadsheet software comparing the stresses calculated from test strain gauge readings with analytical stresses from FEA.
 - iv). For gauges applicable to the individual tests, the percent difference between the two values shall be within $\pm 15\%$ for 80% of the compared values of the test results and analytical results for each gauge type, with none beyond $\pm 30\%$.
 - (1) This shall not include load cells.
 - v). It is assumed all gauges of interest will target areas of stress over 35% of the allowable stress.
 - vi). Additional strain gauges can be used for experimental or reference only purposes but shall not help satisfy the gauge count requirements and shall be clearly identified as such in all documentation.

- (1) Such experimental gauges may be applied on or extremely close to weld joints with no penalty to the correlation requirements but are not exempt from the yielding requirements and thus must measure and record data the same as the required gauges.
- vii). If the analyses results do not agree with the test results within the above-specified tolerance, the Contractor shall revise the stress analyses, update the FEM, and re-run all FEA.
 - (1) All manual analyses using data from the FEA shall be recalculated using the corrected values.
 - (2) This process shall be repeated until agreement of results is within the specified tolerance.
 - (3) The stress analysis report shall be revised and re-submitted.
 - (4) All results from re-analysis shall meet specification requirements.
 - (5) The design shall be corrected if such requirements are not met.
- viii). Analytical values which disagree with the test value by more than 15% shall include an individualized and detailed explanation of the reasons for the variance in the carbody test report for individual review and approval by the Authority.
 - (1) This explanation may include supporting manual calculations.
- ix). Approval of the carbody test report shall depend, in part, on the adequacy of the justification for excessive variance between analytical and test stress values.

6.17 CDRLs

CDRL	Description	Due
CDRL 6-01	Method of Corrosion Prevention for Interior Surfaces of Enclosed Structural Sections	30 days prior to PDR
CDRL 6-02	Three Samples of all Exterior Finishes	30 days prior to FDR
CDRL 6-03	Visible weld and bolt patterns	30 days prior to PDR
CDRL 6-04	Detailed Fatigue Analysis	30 days prior to PDR and on-going through each DR
CDRL 6-05	PDR – Cross sections of the emergency roof access locations	30 days prior to PDR
CDRL 6-06	IDR – Cross sections of the emergency roof access locations	30 days prior to IDR
CDRL 6-07	FDR – Cross sections of the emergency roof access locations	30 days prior to FDR

CDRL 6-08	FAI – Cross sections of the emergency roof access locations	30 days prior to FAI
CDRL 6-09	Emergency Egress Plan and Emergency Responder Ingress Procedure	30 days prior to PDR
CDRL 6-10	Jacking Pad Locations	30 days prior to PDR
CDRL 6-11	Safety Appliance Placement Ergonomic Evaluation	30 days prior to PDR
CDRL 6-12	FRA Sample Car Inspection for Safety Appliance Applications	30 days prior to FAI
CDRL 6-13	Equipment Compartment Access Points and Attachments to the Carbody - Final Dimensions and Arrangement	30 days prior to PDR and on-going through each DR
CDRL 6-14	Glazing Design	30 days prior to PDR
CDRL 6-15	Exterior Surface Treatment Plans	30 days prior to PDR
CDRL 6-16	Carbody Structure Stress Analysis and Test Plan	NTP + 120 Days
CDRL 6-17	PDR – Finite Element Model Electronic Copies	30 days prior to PDR
CDRL 6-18	FDR – Finite Element Model Electronic Copies	30 days prior to FDR
CDRL 6-19	FAI – Finite Element Model Electronic Copies	30 days prior to FAI
CDRL 6-20	PDR – Preliminary Stress Analysis Results	60 days after approval of Stress analysis and Test Plan [CDRL 6-16]
CDRL 6-21	Stress Analysis Result Report Format	30 days prior to PDR
CDRL 6-22	Stress Analysis Result Report	30 days before FDR
CDRL 6-23	FEA Model Verification – Tabulation of test results to analysis	During FDR

* End of Chapter 6 *

Amtrak Long Distance Bi-Level Fleet Replacement

Technical Specification

7. Trucks

Revision 1

Table of Contents

7.1	Overview	7-1
7.2	General Requirements	7-1
7.3	Vehicle/Track System Qualification	7-2
7.4	Vehicle Dynamic Performance Requirements.....	7-5
7.5	Truck-to-Carbody Connection.....	7-8
7.6	Truck Clearance	7-9
7.7	Truck Structural Design	7-9
7.8	Truck Component Design.....	7-12
7.9	Wheel and Axle Assembly	7-15
7.10	Shock Absorbers (Dampers) and Shock Mounts	7-18
7.11	Shock and Vibration	7-19
7.12	Ride Quality Measurement System	7-19
7.13	Electrical Wiring.....	7-19
7.14	Painting	7-21
7.15	Handbrake Linkage	7-21
7.16	Height Adjustment and Shimming.....	7-21
7.17	Truck Classification Plate	7-21
7.18	Maintainability.....	7-22
7.19	CDRLs.....	7-22

7.1 Overview

- a). This chapter covers the truck design for Amtrak's Bi-level Long Distance Fleet Replacement.
- b). The cars shall be equipped with trucks designed for safe and reliable operation at all speeds and cant deficiencies up to their maximum, on all FRA Classes of track up to and including Class 8.
- c). Maximum operating speed of 110 mph and 4 inches cant deficiency.
- d). Truck frames may be either cast or fabricated. The trucks shall incorporate braking via a combination of disc and tread brakes. The trucks must be designed to accommodate the maximum static axle load as specified in Chapter 1.
- e). Trucks shall be interchangeable between car types.
- f). Trucks shall be interchangeable between A-end and B-end of each car to the greatest extent possible.

7.2 General Requirements

- a). The truck assembly shall be designed for operations specified in Chapter 1, under the environmental and operating conditions identified in Amtrak Specification 963, including track configurations.
- b). Truck designs must have a proven service history in rail service or must be a derivative of such a design and must be demonstrated as being compliant with all structural Specification requirements through finite element analysis and testing, and all truck dynamic behavior Specification requirements through computer simulation (validated as defined by Amtrak) and instrumented testing at an approved test track facility.
- c). Truck components which are already in use and service proven on Amtrak's current fleets are preferred.
- d). All truck frames and bolsters (if used) shall be directly interchangeable between all A-end or B-end locations of all car types in the fleet.
- e). All materials and workmanship shall meet the requirements of Chapter 19.
- f). The truck shall be equipped with the brake equipment specified in Chapter 9.
 - i). The disc and tread brake arrangement shall be sufficient for the thermal load produced by the specified braking performance.
 - ii). Brake equipment shall provide braking rates as identified in Chapter 9.
- g). The Contractor shall provide instructions in the appropriate Maintenance Manuals for allowable repair welding procedures for the truck.
- h). The use of Amtrak's NSH Stan-Ray wheel truing machine for re-profiling wheels while mounted on a car without requiring any degree of truck disassembly shall be

possible.

- i). Access to the ends of the axle for wheel truing shall be available without the removal of any additional parts, including roller bearing end caps (with the exception of plugs, end-of-axle grounding devices or axle tachometer generators).
- i). Components, such as air valves and linkages, wheel slide sensors, speed sensors and wiring shall be located as best as possible to protect them from debris strikes or have shields added.
- j). To the greatest extent possible, the Contractor shall provision for allowing wayside scanning images of major components, and provision for dimensional reference markers, (points to provide visual image data capture of conditions of wear or degradation) to be used with intelligent image-based railway inspection systems.
- k). To the greatest extent possible, the truck design should include operational redundancy to minimize mid-route removal of cars from service.
 - i). Specifically, redundancy and protection against debris strikes and premature component failures should be considered in the design.

7.3 Vehicle/Track System Qualification

- a). Each car type must meet the requirements of 49 CFR Part 213.57, Part 213.329 (d), and the requirements of 49 CFR Part 213.345 for service operation up to the maximum speed and cant deficiency specified in Chapter 7.1.
- b). The truck dynamic characteristics shall be suitable for the trainset application and must demonstrate appropriate response for all speeds, curves, spirals and turnouts, and for all typical track perturbations found within defined safety limits of FRA track geometry standards and as described in this Specification.
 - i). The truck design must meet this level of suitable performance without use of a tilt system.
- c). Vehicle Dynamic Performance Qualification Plan
 - i). The Contractor shall submit a vehicle dynamic performance qualification plan for Amtrak review and acceptance **[CDRL 7-01]**.
 - (1) The purpose of this plan is to outline the documentation, process and steps which will be followed to ensure all vehicle dynamic performance requirements are met and ensure timely FRA approval of the planned operation.
 - (2) The plan shall outline the approach for each project phase through concept development, design, simulation, testing and model validation.
 - (3) At a minimum this plan must include:
 - (a) Overview of proposed qualification process, key milestones and planned documentation.

CONFIDENTIAL — DO NOT DISTRIBUTE

- (b) Outline of planned simulation cases and pass/fail criteria.
 - (c) Preliminary listing of track geometry inputs and rail profiles.
 - (d) Listing of planned tests and test locations for all component and pilot car tests.
 - (e) Preliminary listing of testing and test location support required from Amtrak (facilities, equipment, employees, etc.).
 - (f) Outline of FRA submittals required in each project phase for vehicle qualification per 49 CFR Part 213.345. Please reference 49 CFR 238.111 for guidance on documentation specific to the acceptance testing project phase.
 - (g) Outline of simulation model validation plan (i.e. plan for correlation of simulation predicted results with physical test results to ensure validity of the simulation model).
- ii). After the vehicle dynamic performance qualification plan is approved by Amtrak, each of the subsequent documents listed in Sections 7.3(d) through 7.3(g) below shall be submitted for review and approval.
 - iii). Periodic vehicle dynamic simulation review meetings between the Contractor and Amtrak will be required as the project progresses through each phase.
 - iv). It is Amtrak's intent to work collaboratively with the Contractor to ensure that the vehicle dynamic model properly represents the vehicle design and that track inputs represent the actual operational environment.
 - v). During these vehicle dynamic simulation meetings, Amtrak must be able to review the fully detailed simulation model, track inputs and results in the native simulation software environment.
- d). Vehicle Dynamic Simulation Plan
 - i). The Contractor shall submit a detailed vehicle dynamic simulation plan for Amtrak review and approval **[CDRL 7-02]**
 - (1) Details of all planned simulation cases and pass/fail criteria.
 - (2) Preliminary listing of key simulation model parameters (mass, suspension type, key dimensions, wheel profile).
 - (3) Description of vehicle model and planned simulation software.
 - (4) Definition of speed and track geometry inputs.
 - (5) Vehicle dynamic simulations must be performed using an industry recognized software (NUCARS, VAMPIRE, SIMPACK, etc.).
- e). Vehicle Dynamic Simulation Report

- i). A vehicle dynamic simulation report must be submitted during the vehicle design process for Amtrak review and approval **[CDRL 7-03]**. At a minimum this report must include:
 - (1) Tabulation of results for all simulation cases.
 - (2) Model parameters fully defining all dimensions, masses, wheelsets, suspension components and friction elements along with an indication of the source of the data (manufacturer specification, Contractor specification, measured data, calculation, etc.).
 - (3) Wheel profile(s), rail profile(s) and resulting wheel-rail contact plots.
 - (4) Detailed plots of simulation results as requested by Amtrak.
- f). Vehicle Dynamic Model Validation Plan
 - i). A validated vehicle model is required by 49 CFR 213 Appendix D(2)(a). A vehicle dynamic model validation plan must be submitted to Amtrak for review and approval **[CDRL 7-04]**. At a minimum this plan must include:
 - (1) List of planned quasi-static vehicle characterization tests (static lean, wheel equalization, modal vibration test, truck rotational stiffness, etc.).
 - (2) List of vehicle dynamic on-track tests (curving, lateral track perturbation, vertical track perturbation, high speed stability).
 - (3) List of planned suspension component tests (springs, dampers, bumpers, traction rods, friction elements, etc.).
 - (4) Proposed methods for comparing simulation and test data, including variables to be compared (force, acceleration, modal frequencies, etc.) and acceptance criteria which demonstrated the model has been validated.
 - (5) Reference APTA-PR-M-S-031-22 Low-Speed Curving Performance, Chapter 2.7, Validations, for additional guidance.
- g). Vehicle Dynamic Model Validation Report
 - i). A vehicle dynamic model validation report must be submitted to Amtrak for review and approval **[CDRL 7-05]**.
 - ii). The purpose of this report is to demonstrate that the simulation model has been validated by correlating the simulation predicted results with the physical testing results.
 - iii). This report must include correlation of suspension component and vehicle level test results with model inputs and results.
 - iv). If this validation effort requires updates to the model, a revision of the vehicle dynamic simulation report must also be submitted.

7.4 Vehicle Dynamic Performance Requirements

- a). Wheel Load Equalization
 - i). The trucks shall conform to the latest revision of APTA PR-M-S-014-06, Wheel Load Equalization of Passenger Railroad Rolling Stock, for Class G equipment.
 - ii). Per FRA Safety Advisory 2013-02, the suspension system shall control static wheel-load distribution when the equipment is stationary on level track such that the lightest wheel load deviates by no more than 5% from the nominal wheel load for a given truck.
- b). Static Lean
 - i). Maximum Cant Deficiency – Each car type shall meet the requirements of 49 CFR Part 213.329 (d) for wheel unloading and carbody roll angle.
 - ii). Maximum Cant Excess – No wheel shall experience more than 50% wheel unloading when the train is stopped on a 7 inch superelevation.
- c). Wind Loading
 - i). A side-wind loading analysis shall be performed per APTA PR-M-RP-009-98 Rev 2, Section 3.9 using the environmental conditions specified by Amtrak Specification 963.
- d). Low Speed Curving
 - i). Simulations shall be performed according to the requirements of APTA-PR-M-S-031-22 Low-Speed Curving Performance Standard.
- e). Minimally Compliant Analytical Track (MCAT)
 - i). Each car type shall demonstrate acceptable performance for MCAT simulations as defined by 49 CFR 213 Appendix D.
 - ii). For the purposes of 49 CFR 213.345 qualification with the FRA, MCAT simulations shall be run with AW0 car loading and all truck components in the new condition.
 - iii). A select sub-set of additional MCAT simulations for Amtrak information, to be proposed by the Contractor and approved by Amtrak, shall be run with AW3 car loading and all truck components in the new condition.
- f). Representative Service Route
 - i). Each car type shall demonstrate acceptable performance for simulations on track segments of each track Class which are representative of the planned operation as defined by 49 CFR 213.345(c)(2)(ii).
 - (1) Measured track geometry for these simulations will be provided by Amtrak.

- ii). Simulations on representative track segments shall be run with:
 - (1) AW0 car loading and
 - (2) AW3 car loading with all truck components in the new condition.
- iii). Additional simulations shall be run to ensure safety with truck components in the worn or failed condition: broken or collapsed coil spring, inoperative damper, high friction at sliding interfaces, stiffening of elastomeric elements due to low temperature and aging, worn wheels.
 - (1) Amtrak will provide representative worn NRCC6 wheel profiles for simulations.
- g). High Speed Stability
 - i). Each car type must not exhibit truck hunting or sustained vehicle body lateral oscillation up to a maximum service speed of 110 mph, up to a maximum speed of 115 mph (110+5 mph) during qualification testing and up to a maximum speed of 125 mph (110+15 mph) by vehicle dynamic simulation.
 - ii). Limits for sustained truck lateral and vehicle body lateral accelerations are defined by 49 CFR 213.333.
 - iii). Linear Modeling
 - (1) Stability simulations must be performed by linear Eigenvalue analysis with creep factor range of 0.67-1.00 and equivalent wheel conicity range of 0.025-0.400.
 - iv). Non-Linear Modeling
 - (1) Stability simulations must be performed in both new and worn conditions using the full non-linear model running through a lateral track perturbation at sufficient speed to cause hunting.
 - (2) A “top-down speed sweep” must then be used to determine the critical hunting speed.
 - (3) Simulations must use friction coefficient of 0.5 along with combinations of new/worn wheel profiles and new/worn truck components (dampers, friction elements, elastomer elements, etc.).
 - (4) Amtrak will provide representative worn NRCC6 wheel profiles for simulations.
- h). Ride Quality
 - i). A comfortable ride (as defined in this chapter) shall be provided at all permissible speeds under normal operating conditions.
 - ii). Ride quality for all proposed truck designs shall be demonstrated analytically and through actual track testing per the requirements of Chapter 20.

- iii). A comfortable ride shall be provided at all permissible operating speeds for each FRA track class, up to the maximum vehicle service speed.
- iv). A comfortable ride is defined as weighted root mean square (rms) acceleration in the vertical, lateral and longitudinal directions of less than 0.032g (0.315 m/s²) and a crest factor less than 9.
- v). The vibration total value (root sum of squares summation) for each measurement point must not exceed 0.051g (0.50 m/s²).
- vi). Both values must be based on data in the frequency range of 0.5 to 80 Hz using a 3-minute sliding window.
- vii). Weighted rms acceleration and crest factors shall be calculated according to ISO Standards 2631-1 and 2631-4.
- viii). Simulations shall be performed in the AW0 and AW1 load conditions.
- ix). Monitoring locations for ride quality shall be chosen at representative floor and seat locations of each car type.
- i). Natural Frequencies and Damping Rates
 - i). Eigenvalue analysis must be performed to determine the characteristic damped natural frequencies of the vehicle body and trucks (pitch, bounce, yaw, upper center roll and lower center roll).
 - ii). Truck hunting modes (free wheelset kinematic) and truck oscillation modes (parallel wheelset kinematic) must be determined over the full range of speed and expected equivalent wheel conicity range of 0.025-0.400.
 - iii). Characteristic frequencies and damping rates as a percentage of critical damping must be provided.
- j). P2 Forces
 - i). A calculation must be made to show that the vertical track dynamic (P₂) forces do not exceed 68,000 lbs. for a 0.5 degree dip angle and all speeds up to the operating speed limit. The calculation is to consider nominally stiff concrete tie track and to use the British Rail Equation (as defined in British Railways Board Group Standard GM/TT0088 Issue 1).
 - ii). The specific equation to be used is as follows:

$$P_2 = P_0 + 2\alpha v \sqrt{\frac{m_u}{m_u + m_t} \left(1 - \frac{\pi c_t}{4\sqrt{k_t(m_u + m_t)}} \right)} \sqrt{k_t m_u}$$

Where:

P₀ Static wheel load in pounds

α Dip angle in radians

CONFIDENTIAL — DO NOT DISTRIBUTE

v	Vehicle speed in inches/second
m_u	Unsprung mass per wheel in lbf/in/sec ²
m_t	Track mass per wheel in lbf/in/sec ²
c_t	Track damping per wheel in lbf/in/sec
k_t	Track stiffness per wheel in lbf/in

Track parameter values are as follows:

α	0.0085 Total dip angle in radians based on 1/2 degree on both sides of the dip
m_t	1.1335 Track mass per wheel in lbf/in/sec ² for nominally stiff concrete tie track
c_t	671 Track damping per wheel in lbf/in/sec for nominal track conditions (from literature)
k_t	392,900 Track stiffness per wheel in lbf/in for nominally stiff concrete tie track (corresponds to track modulus of 5,100 lb/in/in, assuming a track deflection of 0.084 inches under a 33,000 pound wheel load)

- iii). Calculation of P_2 forces using Contractor proposed alternative values in the British Rail Equation and resulting change in the value of P_2 forces may be considered by Amtrak upon approval of justification for such changes by Amtrak and that such calculations are also approved by the owner of the track or its designated representative.

7.5 Truck-to-Carbody Connection

- a). The truck frames and all components shall be retained to the carbody in accordance with the requirements of 49 CFR Part 238.219 and APTA Standard PR-CS-S-034-99.
- b). The ultimate strength of the truck and the truck-to-carbody connection shall be sufficient to secure the entire truck to the carbody in a manner which will prevent truck separation during derailments, collisions, or other adverse events in which a horizontal load of 250,000 lbs. is applied to the truck frame.
 - i). This load may be transmitted from the truck frame through structural members, positive stops, or other rigid, mechanical safety devices and/or combinations thereof to the carbody bolster.
 - ii). Bolster anchors/traction links (if used) shall not be used to provide any part of this strength.
- c). Vertical safety hangers shall be provided to secure the truck to the carbody.

- d). Depending on truck design, a locking center pin may satisfy this requirement.

7.6 Truck Clearance

- a). All truck-mounted equipment shall conform to the clearance requirements of Amtrak Clearance Drawing 066-00050 Rev C.
- b). A clearance of at least 2.50 inches shall be provided between truck parts (including wiring, hoses, cables, and chains) and the carbody under AW1 load and the most unfavorable dynamic combination of vertical and horizontal track curvature, wheel wear, lateral and vertical motion, roll, and broken coil springs.
- c). The minimum clearance above the top of the running rail, except for wheels, shall be 2.50 inches including allowances for worn wheels, full vertical travel of the suspension system (including failed condition) and full passenger loading.

7.7 Truck Structural Design

a). Structural Validation Plan

- i). The Contractor shall submit a structural validation plan as outlined by APTA PR-M-RP-009-98 Rev 2, Section 3.1.5, for Amtrak review and approval **[CDRL 7-06]**.
- ii). The purpose of the validation plan is to describe in detail the list of the steps planned to demonstrate structural safety and compliance with the requirements defined in the technical specification.
- iii). The validation plan shall act as a guide for the design and testing process.
- iv). After the structural validation plan is accepted by Amtrak, each of the subsequent truck structural analysis and test documents listed below shall be submitted for review and approval.

b). Truck Structural Analysis and Test

- i). The Contractor shall submit each document outlined below, detailing each step of the structural validation plan, for Amtrak review and approval.
 - (1) Truck Stress Analysis Plan **[CDRL 7-07]**
 - (2) Truck Stress Analysis Report **[CDRL 7-08]**
 - (3) Truck Stress Test – Laboratory, Plan **[CDRL 7-09]** (see requirements in Chapter 20 – Truck Frame and Bolster Load Tests)
 - (4) Truck Stress Test – Laboratory, Report **[CDRL 7-10]**
 - (5) Truck FEA Structural Model Validation Plan **[CDRL 7-11]** (can be combined with CDRL 7-09)
 - (6) Truck FEA Structural Model Validation Report **[CDRL 7-12]** (can be combined with CDRL 7-10)

- (7) Truck Stress Test – On-Track, Plan [CDRL 7-13]
 - (8) Truck Stress Test – On-Track, Report [CDRL 7-14]
 - (9) Fatigue Assessment Validation Report [CDRL 7-15]
 - (10) Manufacturing Validation Report [CDRL 7-16]
- c). Allowable Stress
- i). Fatigue
 - (1) Contractor and/or the truck designer shall determine the maximum allowable stresses for the truck frame, bolster and truck components in order to perform without degradation over the 40-year useful life.
 - (2) The allowable stresses shall be determined using industry standard practice and shall be submitted to Amtrak for review and approval as part of the truck stress analysis plan.
 - ii). Static
 - (1) Maximum allowable stress shall be 55% of the yield strength of the material.
 - iii). Overload
 - (1) Maximum allowable stress shall be the yield strength of the material. No permanent deformation allowed in structural elements.
- d). Truck Design Loads
- i). The loads specified herein are minimum values.
 - ii). The Contractor shall be responsible for selecting loads that will develop a high level of confidence in the adequacy of the truck design for the intended purpose and application.
 - iii). The highest vertical load of all car types, as seen at the truck, shall be used for the loadings.
 - iv). Loads marked by double asterisk (**) shall be included in the stress analysis but will not be applied during the laboratory truck stress test.
 - (1) Fatigue
 - (a) Vertical – $1.0g \pm 0.2g$ x AW1 loaded carbody weight per truck.
 - (b) Lateral – $\pm 0.15g$ x AW1 loaded carbody weight per truck applied at the carbody center of gravity.
 - (c) Longitudinal – $\pm 0.15g$ x AW1 loaded carbody weight per truck applied at the carbody center of gravity.

- (d) Braking – Full-service braking, split between tread and disc mounting locations according to Chapter 9.
- (e) Twist – One wheel lifted/lowered length equal to 1% of wheelbase.

**Dampers – +/-100% of maximum dynamic condition.

**Truck-Mounted Equipment Mass Inertia Loads

- v). Vertical, lateral, longitudinal and braking loads shall be applied simultaneously with phasing and directions which represent the operating environment.
 - vi). Damper and truck-mounted equipment loads are for localized analysis of brackets and mounts.
 - vii). Twist load shall be applied in combination with vertical load only.
 - (1) Static
 - (a) Vertical – 110% of AW3 loaded carbody weight per truck.
 - (b) Lateral – 25% of the vertical load, applied at the carbody center of gravity.
 - (c) Longitudinal – 15% of the vertical load, applied at the carbody center of gravity.
 - (d) Vertical, lateral, and longitudinal loads shall be applied simultaneously.
 - (2) Overload
 - (a) Vertical – 1.5g x AW3 loaded carbody weight per truck.
 - (b) Lateral – 0.3g x AW3 loaded carbody weight per truck applied at the carbody center of gravity.
 - (c) Longitudinal – 1.0g x truck weight.
 - (d) Braking – Maximum specified deceleration, split between tread and disc mounting locations according to Chapter 9.
 - (e) Twist – Complete wheel unloading at one wheel with Vertical – 1.0g x AW3 loaded carbody weight per truck.
- **Dampers – 2 x damper force at reference speed.
- **Truck-Mounted Equipment Mass Inertia Loads.
- viii). Vertical, lateral, longitudinal and braking loads shall be applied simultaneously. **Damper and truck-mounted equipment loads are for

localized analysis of brackets and mounts. Twist load shall be applied in combination with vertical load as listed.

e). Truck-Mounted Equipment Mass Inertia Loads

i). Truck Frame Mounted Equipment

Direction	Fatigue Acceleration	Overload Acceleration
Vertical	+/- 12 g	+/- 40 g
Lateral	+/- 10 g	+/- 20 g
Longitudinal	+/- 5 g	+/- 10 g

ii). Axle and Axlebox Mounted Equipment

Direction	Fatigue Acceleration	Overload Acceleration
Vertical	+/- 50 g	+/- 140 g
Lateral	+/- 10 g	+/- 20 g
Longitudinal	+/- 10 g	+/- 20 g

7.8 Truck Component Design

a). Detailed drawings of all truck components shall be provided to Amtrak, such that replacement components can be sourced/manufactured in the future as necessary.

b). For cast and fabricated components, this includes material, heat treatment, dimensions, surface finish, etc. **[CDRL 7-17]**

c). Truck Frame and Bolster

i). Truck frames and truck bolsters (if used) shall be of cast or fabricated steel construction.

(1) They shall be heat stress-relieved after all primary welding is completed, unless otherwise approved by Amtrak.

(2) Critical areas of all welds and castings shall be magnetic-particle inspected per ASTM Standard E709 on all production units.

(3) Radiographic inspection per ASTM Standards E94, E446 and E186 and ultrasonic inspection per AWS D.1.1 shall be used to qualify fabrication and casting techniques and for periodic inspection of production lots, see Chapter 19.8.2.

ii). All truck frame and bolster (if used) openings or voids shall be sealed with plugs or similar arrangements, to prevent the accumulation of wayside debris such as leaves therein.

- (1) The sealing means shall have life expectancy of 40 years, subject to Amtrak review and approval.
- iii). All wearing parts or surfaces shall be provided with renewable liners or bushings.
 - (1) Truck frame pedestals, if used, shall be lined with low-friction components to minimize wear.
 - (2) If possible, the truck design shall permit replacement of pedestal liners without requiring the removal of the wheelset.
- iv). Retainers shall be provided to prevent an axle from leaving the truck, and to also prevent any primary suspension element from leaving its proper position, when the car is lifted with the trucks attached, or in the event of a derailment.
 - (1) It shall be possible to change a wheelset expediently by removing the axle retainer and lifting the car above the wheelset (after intra-car couplings are disconnected), to facilitate changing wheels in location without a drop table, including changing wheelsets in the field after a derailment.
- v). The truck frame shall include attachment points for lifting by a shop crane which are eyelets or lifting tabs at the frame corners with a minimum through hole diameter of 2 inches.
- d). Bolster Anchor
 - i). Longitudinal forces shall be transmitted between the truck and the carbody through bolster anchors or similar method.
 - ii). The bolster anchors, if used, shall be designed to accommodate longitudinal, swiveling and vertical forces encountered during operation on all classes and conditions of track identified in Amtrak Specification 963.
 - iii). Elastomeric bushings at the bolster anchor ends shall be designed for a minimum functional service life (95% survival) of eight years.
 - iv). Bolster anchors must be designed to transfer traction and braking loads between the carbody and truck, and act as a frangible element which protects the carbody and truck attachment points from damage under overload conditions.
 - v). Bolster anchors must be analyzed to demonstrate infinite fatigue life under 125% of the maximum expected traction and braking loads.
 - (1) Bolster anchors must be analyzed to determine the overload condition which will result in tensile and buckling failure of the anchors.
 - (2) These loads must not cause permanent deformation of the carbody or truck attachment brackets.

- vi). See Chapter 6 for other requirements for the bolster anchor and related carbody mounting points.
- e). Suspension
 - i). Coil springs and/or rubber element suspension components may be used for primary suspension.
 - ii). Elastomeric suspension components shall be designed for a minimum functional service life (95% survival) of eight years.
 - iii). Dampers shall have a minimum functional life (95% survival) of five years.
 - iv). The Contractor shall provide analyses to demonstrate the effect of asymmetric forces from braking on primary suspension deflection, wheelset angle of attack and body yaw accelerations. **[CDRL 7-18]**
 - v). The carbody secondary suspension shall be provided by coil springs.
 - vi). The secondary suspension shall include internal resilient stops to limit vertical travel and act as an “backup spring” should the main spring element fail.
 - vii). All metal springs shall be mounted using resilient mounting pads to prevent metal-to-metal contact and provide sound and vibration deadening.
 - viii). All mounted equipment shall be designed for ease of inspection, tramming, access, replacement and maintenance, including allowances for witness point or reference marks to assist in automated visual inspection machines.
 - ix). Elastomeric primary springs shall be secured to the truck frame when axle assemblies are removed.
 - x). Elastomeric primary springs shall be color-coded for spring rate and shall be installed in matching sets, with only one color-code per truck.
 - xi). Components shall also be visible from the wayside so that condition of these items can be achieved via video wayside capture.
 - xii). All coil springs shall meet the latest revision of Amtrak Specification 563 and follow the recommended practices of APTA PR-M-RP-009-98, Section 3.5, Helical Coil Spring Design Guidance.
 - xiii). The Contractor shall submit coil spring design stress calculations for Amtrak review and approval **[CDRL 7-19]**.
 - xiv). Coil springs shall be grouped by height under AW0 load after manufacturing, then marked to clearly identify group for each spring (banding, color-coded, etc.).
 - xv). All springs must be in the same group for a given truck.
- f). Stops and Wear Plates

CONFIDENTIAL — DO NOT DISTRIBUTE

- i). Rubber stops limiting vertical and lateral motion shall be designed with a progressive compression rate and shall not exceed 90% of their design compression under any condition that can be developed in the truck.
 - ii). Lateral stops shall limit the motion of the carbody to stay within the clearance in either direction.
 - iii). Stops that limit truck over-rotation shall be designed to prevent metal-to-metal contact.
 - iv). Low friction coefficient wear plates used for sliding surfaces shall be designed for a minimum functional service life (95% survival) of eight years.
- g). Adjustments
- i). Provisions shall be made for adjusting the carbody height to compensate for wheel wear or other variations and shall have provisions for being captive.
 - ii). Adjustments to carbody height shall not impact ride quality.
 - iii). Suspension design shall permit adjustments to be made without disconnecting the truck from the carbody.

7.9 Wheel and Axle Assembly

a). General

- i). The Amtrak bi-level wheelset, which is already in service on Amtrak Superliner cars, shall be provided with a modified axle to accommodate a Class K journal bearing. References for this wheelset are:
 - (1) Amtrak Drawing C-62-0061
 - (2) Amtrak part number 2975401508
- ii). A conventional wheel and axle assembly shall consist of an axle, two wheels, two outboard journal bearings, two brake discs, speed sensor gear at one bearing per axle, and associated materials.
- iii). Mounting graphs and inspection records shall be included in each vehicle history book for all components.
- iv). If existing Amtrak bi-level wheelset is deemed incompatible with the new car designs, alternate wheelsets may be proposed by the Contractor and approved by Amtrak.
- v). Wheel and axle assemblies shall utilize materials made to the same specifications as above and insofar as deemed practical by the Contractor, components in common with the conventional wheel and axle assembly shall be used unless otherwise approved by Amtrak.
- vi). All wheelset components shall be manufactured and assembled by a supplier currently certified under the AAR Standard M-1003.

CONFIDENTIAL — DO NOT DISTRIBUTE

- b). Axles
- i). The Amtrak Superliner 6-1/2 x 12 Axle, which is already in service on Amtrak Superliner cars, shall be provided with modifications to accommodate a Class K journal bearing.
 - ii). The journal bearing centerline spacing shall be maintained at 79.00 inches. References for this axle are:
 - (1) Amtrak Drawing D-08-1301
 - (2) Amtrak part number 2975400505
 - iii). The axle shall be designed according to APTA PR-M-RP-008-98, Rev.2, Passenger Rolling Stock Axle Design.
 - iv). The axle shall be solid, forged, Grade "F", carbon steel meeting the chemical composition (with restriction of 0.50% maximum silicon content) and mechanical property requirements of AAR Standard M-101, arranged for outboard journal bearings.
 - v). Axle design and application shall be confirmed with theoretical stress calculations **[CDRL 7-20]**.
 - vi). Axles shall be designed to meet or exceed performance and applicable safety standards.
 - vii). Material and heat treatment certification shall be provided with vehicle history final reports.
 - viii). Each axle shall be inspected by both the wet fluorescent magnetic particle and ultrasonic methods.
 - ix). A record of all certification and heat numbers shall be supplied to Amtrak.
 - x). If possible, the axle shall have an oversize wheel seat to provide longer service life.
- c). Wheels
- i). The Amtrak Superliner B-36 Class B Wheel, which is already in service on Amtrak Superliner cars, shall be provided. References for this wheel are:
 - (1) Amtrak Drawing D-062-00105
 - (2) Amtrak Part Number 2975401807
 - ii). The wheels shall be 36 in. diameter (nominal) Class B, wrought steel multiple-wear type, of a low stress (S-plate) design, conforming to AAR Standard M-107 and M-208, APTA Standard PR-M-S-012-99 Rev.2, and Amtrak Specification 771, latest issue.

- iii). The wheels shall be inspected by both the wet fluorescent magnetic particle and ultrasonic methods.
 - iv). Wheel tread profile shall be in accordance with Amtrak wheel profile NRCC6 per drawing 62-00106, Revision D, unless otherwise approved by Amtrak.
 - v). A record of all certification and heat numbers shall be supplied to Amtrak.
 - vi). Analytical evaluation of the wheel design for combined mechanical and thermal overload conditions shall be performed according to AAR S-660, with thermal input load adjusted to represent the selected tread/disc braking configuration and Amtrak service.
 - (1) Analytical evaluation of the wheel design for fatigue loading shall be performed according to AAR S-669.
 - (2) The results of these analyses shall be submitted to Amtrak for review and approval [**CDRL 7-21**].
 - vii). Any wheel plate that is not currently approved needs not only Amtrak approval but also AAR WABL approval.
- d). Brake Discs
- i). For brake disc requirements, see Chapter 9.
 - ii). Note that the Amtrak bi-level wheelset, referenced by Section 7.9 (a), includes brake discs which are already in service on Amtrak Superliner cars.
- e). Axle Journal Bearings
- i). The journal roller bearings on conventional axles shall be outboard located, fully enclosed, rotating end cap, grease lubricated, AAR Class "K" roller bearings.
 - ii). They shall be configured for No Field Lubrication (NFL), with Hydrodynamic Labyrinth (HDL) seals (or equivalent).
 - iii). The L10 design life of the journal bearing shall be at least 1 million miles under AW1 loading with a 1.3 loading factor.
 - iv). The Contractor shall provide design analysis to verify the roller bearing estimated L10 life. [**CDRL 7-22**]
 - v). The journal bearing end cap shall incorporate a toothed speed sensor gear and be equipped with a center plastic plug.
 - vi). The speed sensor design must always see the end cap gear teeth under the worst conditions of manufacturing tolerances and wear thresholds for the journal bearing housing, bearing, sensor, etc.
 - vii). The end cap shall provide access to the axle center for wheel truing without removal of the journal bearing mounting bolts or end cap.

- viii). Journal roller bearings shall be new and meet the requirements of Amtrak Specification 900, *Purchase of New or Reconditioned Roller Bearings*.
- f). Axle Bearing Housings
 - i). Removable axle bearing housings shall be provided.
 - ii). Pressing shall not be required to remove the housing from the bearing.
 - iii). Axle bearing housings shall be common for all locations, including a provision for mounting a speed sensor.
 - iv). Each axle bearing housing shall include a hot bearing sensor, such as Amtrak Drawing D-00-7075 Hot Bearing Detector Probe or approved equivalent.
 - v). Temperature sensing system shall be tied into the CDU for monitoring and temperature trending purposes and shall have the capability to be monitored remotely.
- g). Wheelset Assembly
 - i). Each wheelset shall be assembled using an AAR certified facility, and must be in compliance with the requirements of:
 - (1) Amtrak specification 907, APTA-PR-M-S-019-17, *Passenger Wheel Set Assembly*, latest issue, and
 - (2) AAR Manual of Standards and Recommended Practices, Section G, Parts I and II, *Wheel and Axle Manual*.
 - ii). A wheelset inspection record shall be completed for each wheelset, which shall include component press tonnage charts, all component serial numbers and inspection measurements.
 - iii). Torque seal shall be applied to the head of all fasteners after torquing.

7.10 Shock Absorbers (Dampers) and Shock Mounts

- a). Lateral, yaw and vertical motion of the trucks and carbody shall be damped through the use of shock absorbers (hydraulic dampers).
- b). Shock absorbers, if used, shall terminate in elastomeric bushed connections to eliminate metal to metal contact.
- c). All shock absorbers shall be accessible for replacement without requiring the removal of the trucks from the carbody.
- d). Shock absorber mounting brackets on the trucks and carbody shall be designed to last the life of the carbody without wearing, deforming, loosening or otherwise requiring repair, excluding bushing replacement.
- e). The equipment shall be mounted to protect against debris strikes.

- f). Components shall also be visible from the wayside so that condition of these items can be achieved via video wayside capture.
- g). Durability of the shock absorbers, their mounting brackets and bushings shall be demonstrated analytically and through accelerated life cycle testing simulating actual shock absorber functional service life.
- h). Test plan for the shock absorbers and shock mounts shall be submitted to Amtrak for approval as part of the Contractor's proof of design testing (see Chapter 20).
- i). The shock absorbers shall be appropriately rated for a service life (95% survival rate) of no less than five years.

7.11 Shock and Vibration

- a). All pneumatic, electrical and electronic equipment/components mounted to the truck shall be tested for shock and vibration in accordance with IEC 61373 (1999) – *Railway Application, Rolling Stock Equipment, Shock and Vibration Tests*.
- b). All electrical equipment and electrical enclosures should be protected from the effects of the environment and have NEMA 4 or at minimum IP64 ingress protection.

7.12 Ride Quality Measurement System

- a). All End Coach cars, Premium Coach cars, Lounge cars and Utility cars shall be equipped with an rMetrix ride quality measurement system (RQMS), manufactured by dFuzion, Inc.
- b). The system shall include at least one truck-mounted triaxial accelerometer, one carbody-mounted triaxial accelerometer and one GPS receiver.
- c). All diagnostics shall be reported out to the CDU and be able to be viewed remotely.
- d). The RQMS system must meet the following minimum functional requirements:
 - i). Continuously record, analyze, and report V/TI data including acceleration, vehicle location, heading and speed.
 - ii). Storage of all V/TI data for a period one year.
 - iii). Calculate all V/TI exceptions based on the FRA safety requirements per 49 CFR Part 213.333.
 - iv). Capability to perform fleet wide reporting and analytics.
 - v). Extraction of raw data for advanced analysis in third-party applications such as LabView, Matlab, or Microsoft Excel.

7.13 Electrical Wiring

- a). All electrical wiring shall be protected from damage during service.

- b). Watertight connections shall be provided for connecting electrical devices.
- c). All requirements listed by APTA-PR-M-RP-009-98_R2, Section 3.7.2, Electrical Wiring and Pneumatic Piping, shall be met.
- d). Speed Sensor
 - i). A speed sensor cable shall be provided on each truck to transmit a signal from the speed sensor on each axle to the wheel slip control system (see Chapter 9).
 - ii). The speed sensor cables shall be attached to the truck frame using elastomer-coated steel clamps on dedicated mounting pads that provide secure attachment while not abrading or pinching the cable.
 - iii). Clamps shall be securely fastened to the truck frame.
 - iv). Appropriate slack shall be incorporated into the cable length to allow free movement of trucks and truck components while providing adequate securement for the cable.
 - v). Cables shall be routed to prevent damage from pinching, stretching or catching on adjacent equipment.
 - vi). Furthermore, cables and equipment should be protected against debris strikes.
 - vii). Speed sensor and cables shall be per Amtrak Drawing D-00-1359, *Speed Sensor and Cable Assembly*.
- e). Grounding
 - i). An electrical ground path using highly flexible copper cables or straps and ground brushes/rings shall be provided from the carbody to the rail.
 - ii). Grounding paths shall be run from the truck frame to the truck bolster (if used) and from the truck bolster to the carbody.
 - iii). Grounding cables or straps shall not restrict the movement of truck components and shall remain slack under all operating and maintenance conditions.
 - iv). Components shall also be visible from the wayside so that condition of these items can be achieved via video wayside capture.
 - v). Two grounding brush/ring assemblies per truck, one per axle, shall be installed providing a grounding path between the truck frame and axle to bypass current return through the journal bearings.
- f). Shunting

- i). The trainset, its trucks, and its wheelsets shall be designed such that the maximum rail to rail resistance through the trainset shall be no greater than 0.010 Ohms in any combination of vehicles.
- ii). It is preferred that the standard truck and wheelset design be capable of achieving the required shunting performance; however supplemental devices may be incorporated into the truck design to aid shunting.
- iii). Any such supplemental equipment shall be designed in accordance with Amtrak Specification 1118.

7.14 Painting

- a). The truck manufacturer shall apply at least one coat of a metal primer on all exposed surfaces of the trucks immediately after final assembly cleaning, repairs, and inspection.
- b). A final coat of an ASTM B-117 1,000 hour paint shall be applied using an Amtrak-approved color.

7.15 Handbrake Linkage

- a). Truck mounted hand brake linkage shall be lever type.
- b). Chains are preferred, however, cables may be used on the truck itself to interconnect the components.
- c). All trucks shall be equipped with necessary attachment points for hand brake linkage and shall accommodate the full range of car height adjustment.
- d). Refer to Chapter 9 Brakes for operator details.

7.16 Height Adjustment and Shimming

- a). Approved provisions shall be made for adjusting the carbody height up to 2.50 inches to compensate for wheel wear or other variations.
- b). The design and method of height adjustment shall allow for quick and easy adjustment without disassembly of the truck or removal of the truck from the car.
- c). This methodology can be achieved through the use of special tools, subject to Amtrak approval.
- d). Height adjustment may be by shimming, component adjustment or component exchange, to be proposed by the Contractor and approved by Amtrak.
- e). All coil springs and shims shall be positively captured at both top and bottom surfaces.
- f). Visual indication of shimming limits (maximum shim height) shall be provided at each respective shim location.

7.17 Truck Classification Plate

CONFIDENTIAL — DO NOT DISTRIBUTE

- a). Amtrak standard truck classification plate shall be mechanically applied to both sides of each truck. The truck classification plate shall contain the following information:
 - i). Amtrak name and symbol
 - ii). Bearing size
 - iii). Center-plate loading
 - iv). Wheel size and type
 - v). Truck serial number (to be permanently stamped into the plates)
 - vi). Manufacturer
 - vii). Manufacturer's part number
 - viii). Date of manufacture

7.18 Maintainability

- a). The trucks, and associated components (shocks, etc.), attachment fasteners to the carbody shall be accessible with standard pneumatic or hydraulic tools.
- b). All major components shall be easily accessible and replaceable during repair or overhaul.
- c). The overhaul manual shall include all details of disassembling, tramping, and reassembling the truck frame for routine overhauls.
- d). Rebuild instructions with parts lists shall be provided for all assemblies and subcomponents.
- e). Documentation requirements are described in Chapter 22.

7.19 CDRLs

CRDL	Description	Due
CDRL 7-01	Vehicle dynamic performance qualification plan	NTP + 120 days
CDRL 7-02	Vehicle dynamic simulation plan	PDR
CDRL 7-03	Vehicle dynamic simulation report	IDR
CDRL 7-04	Vehicle Dynamic Model Validation Plan	IDR
CDRL 7-05	Vehicle Dynamic Model Validation Report	Post Type Tests
CDRL 7-06	Structural validation plan	NTP + 120 days
CDRL 7-07	Truck Stress Analysis Plan	PDR
CDRL 7-08	Truck Stress Analysis Report	IDR
CDRL 7-09	Truck Stress Test – Laboratory, Plan	FDR
CDRL 7-10	Truck Stress Test – Laboratory, Report	Post Type Test

CDRL 7-11	Truck FEA Structural Model Validation Plan	IDR
CDRL 7-12	Truck FEA Structural Model Validation Report	Post Type Test
CDRL 7-13	Truck Stress Test – On-Track, Plan	FDR
CDRL 7-14	Truck Stress Test – On-Track, Report	Post Type Test
CDRL 7-15	Fatigue Assessment Validation Report	Post Type Test
CDRL 7-16	Manufacturing Validation Report	IDR
CDRL 7-17	Detailed drawings of all truck components	FDR
CDRL 7-18	Analyses demonstrating the effect of asymmetric forces from braking	IDR
CDRL 7-19	Coil spring design stress calculations	IDR
CDRL 7-20	Axle design and application theoretical stress calculations	IDR
CDRL 7-21	Wheel design analysis for combined mechanical and thermal overload conditions per AAR S-660	IDR
CDRL 7-22	Design analysis verifying roller bearing estimated L10 life	IDR

* End of Chapter 7 *

Amtrak Long Distance Bi-Level Fleet Replacement

Technical Specification

8. Couplers and Draft Gear

Revision 1

Table of Contents

8.1	Overview	8-1
8.2	General Requirements	8-2
8.3	Performance Requirements.....	8-2
8.4	Coupler and Yoke.....	8-3
8.5	Draft Gear	8-3
8.6	Coupler Carrier.....	8-3
8.7	Coupler Uncoupling Mechanism.....	8-4
8.8	Mounting Arrangement.....	8-4
8.9	Crash Energy Management.....	8-4
8.10	Low Slack Couplers.....	8-5
8.11	CDRLs.....	8-6

8.1 Overview

- a). The long-distance fleet will consist of several configurations to achieve proper service for our passengers. These configurations will include cars that shall be equipped with an APTA standard Type H Tightlock coupler and associated draft gear as well as a dedicated core which will be secured with a Low Slack Coupler design.
 - i). The dedicated core will be referred to as the “trainset” throughout this chapter.
 - ii). Within the trainset, cars shall be equipped with Low Slack Coupler design and associated draft gear.
 - iii). Energy absorbing couplers and draft gears shall be used throughout the consist as required by the Contractor's car design to achieve compliance with FRA carbody strength requirements in 49 CFR Part 238.
- b). The outermost ends of the trainset shall be equipped with an APTA standard Type H Tightlock coupler with associated draft gear, coupler carrier, and uncoupling mechanism.
 - i). The end couplers shall be designed to be physically compatible with, couple to, and operate with standard knuckle couplers and components conforming to APTA or AAR standards.
- c). Intermediate cars within the trainset shall be equipped with low slack coupler design, with associated draft gear and coupler carrier.
 - i). Low Slack Coupler design refers to a coupler which provides greater inter car stability, reducing slack action for safer passenger movement along the trainset.
 - ii). The low slack coupler design must be separable as specified in this chapter.
 - iii). It is intended that a trainset may be separated, and the intermediate car configurations of the trainsets may be modified during revenue service.
 - (1) Removal of a single car from a trainset and return to service shall be feasible within 1 hour without the need for external hoists or fork trucks which may not be available at a location for cutting out of the car from the trainset.
 - iv). Where possible, it is desired that intermediate cars have mounting provisions in their carbody end structure for the installation of an APTA Type H coupler and uncoupling mechanism.
 - (1) Any conversions shall meet the applicable requirements of this chapter as well as Chapter 6.
 - v). Additionally, any intermediate cars without an APTA standard Type H coupler installed shall include provisions for movement in a yard when uncoupling.

- (1) Any adapters or special hardware shall be provided.
- d). All couplers and low slack coupling devices, along with associated draft gear, shall meet the requirements of the FRA in 49 CFR Part 238.
 - i). Alternate coupler arrangements may be proposed to Amtrak for approval.

8.2 General Requirements

- a). The Type H Tightlock coupler and draft gear assembly shall be compliant with the requirements of APTA Recommended Practice PR-M-RP-003-98.
- b). All end couplers, intermediate coupling assemblies, draft gear, and associated components shall conform to the strength requirements specified in all applicable APTA and FRA standards and recommended practices.
- c). Coupler carriers shall be capable of withstanding the vertical forces identified in 49 CFR 238.207.
- d). All components shall be designed to operate properly under the operational and environmental conditions defined in Amtrak Specification 963.
- e). It shall be possible to remove or install an end coupler, Low Slack Coupler and draft gear assembly without requiring lifting of the carbody or removal of the truck.

8.3 Performance Requirements

- a). Under normal operating conditions, all couplers, Low Slack Couplers, articulations and associated apparatus, including coupler carriers, shall be capable of withstanding for any horizontal position of the coupler a vertical load of 100,000 lbs. applied in either direction to the coupler as near to the pulling face as practical, without deformation to the coupler carrier, supporting carbody structure and intermediate connections.
- b). The trainset shall be capable of operating normally while coupled to any other car or locomotive used in passenger service under the operational and environmental conditions defined in Amtrak Specification 963.
- c). Coupler swing shall be such that a trainset shall be able to negotiate a 250-foot radius (23 degree) curve while coupled to other cars and/or locomotives as specified without damage to trucks, draft gear, carbody, gangways, air hoses or car-to-car connections.
- d). End stops or equivalent mechanism shall be installed to prevent damage to car due to a deflected coupler caused by mis-coupling.
 - i). 250-foot radius curve requirement shall be achievable with end stops or equivalent installed.
- e). The coupler air connections shall be designed in conformance with APTA Recommended Practice PR-M-RP-001-97.
 - i). See Chapter 9 for details regarding car-to-car air connections.

- f). It shall be possible to lift the car using the coupler.

8.4 Coupler and Yoke

- a). Material for couplers and yokes shall conform to AAR M-201 for grade E high tensile steel.
- b). The bottom of the end coupler shank shall have a replaceable steel wear plate installed where it contacts the coupler carrier.
- c). Intermediate couplings shall achieve similar performance.

8.5 Draft Gear

- a). The trainset end coupler draft gear characteristics shall be equal or better to twin-cushion WM-6-DP draft gear packs.
- b). The draft gear pockets shall allow for the implementation of push-back couplers if required by the design.
- c). If draft gears are used at the intermediate coupling assemblies, their characteristics shall be designed to take into account the overall trainset ride quality and compliance with any CEM performance requirements, if utilized.

8.6 Coupler Carrier

- a). The coupler carrier shall be designed to support adequately and consistently the coupler through its full range of vertical and horizontal movement.
- b). The coupler shall be supported at a nominal 34.5 in. height Above Top of Rail (ATOR), with an adjustment range of plus/minus 1 in., as measured at the center of the coupler when uncoupled.
- c). The coupler carrier shall be designed to accommodate the complete push-back motion of the coupler without interference if an energy absorption function is used.
 - i). During coupler push-back, contact between the coupler head and the coupler carrier shall not result in unintentional activation of the coupler uncoupling mechanism and therefore cause car separation.
- d). A means shall be provided to allow removal and replacement of wear plates, carrier springs and carrier stops.
 - i). The top surface of the coupler carrier shall be equipped with a replaceable nylon (or other low friction material) wear plate.
 - ii). The coupler shall not rest on a metal surface.
 - iii). Alternate service proven methods appropriate for rail vehicle service and as approved during design review process will be considered.

8.7 Coupler Uncoupling Mechanism

- a). All coupler uncoupling levers and hardware shall meet the safety requirements of 49 CFR Part 238.
- b). Each knuckle coupler shall be equipped with an AAR number 6 uncoupling operating mechanism, in conformance with section 5.10 of APTA Standard PR-M-S-016-06.
 - i). It shall be located on the left side when facing the end of the car.
- c). Minimum clearance of 2 in. shall be maintained between uncoupling mechanism and all other components on the end of the car (including jumper cables, receptacles and carbody structural elements such as collision posts) when car is either coupled or uncoupled.
- d). The uncoupling levers shall seat firmly when locked in place, shall not bind when being used, and shall not rattle or vibrate.
- e). The uncoupling levers shall be designed with a locking mechanism to prevent unintentional unlocking of the coupler due to vibration or debris strikes.
- f). Alternative uncoupling lever designs may be proposed.
- g). The uncoupling mechanism shall be designed to accommodate any push-back motion of the coupler without unintentional activation of the coupler lock mechanism causing car separation.

8.8 Mounting Arrangement

- a). The proposed mounting arrangement of the trainset end coupler assemblies shall be submitted for Amtrak approval during design review. **[CDRL 8-01]**
- b). The proposed mounting arrangement of the intermediate coupling assemblies will be submitted for Amtrak approval during design review. **[CDRL 8-02]**

8.9 Crash Energy Management

- a). If a push-back coupler system is required by design, it shall be coordinated with the carbody Crash Energy Management (CEM) design, if utilized.
 - i). To ensure operational compatibility, any push-back energy absorbing coupler assemblies at the ends shall have a minimum initiation load of 600,000 lbs.
 - ii). The slope of the force during push-back shall be greater than or equal to zero for all CEM elements.
 - iii). The coupling system must be capable of transferring a 150,000 pounds draft load at any time during the push-back sequence to ensure that cars remain coupled during and after an impact.
- b). Indicators shall be provided that shall be visible from outside the car to indicate full

or partial activation of the energy absorption unit and the need for its replacement.

- i). The activation of the energy absorption unit shall be readily apparent when performing periodic inspections.

8.10 Low Slack Couplers

- a). The following requirements are applicable to trainset configuration utilizing Low Slack Couplers between cars of the trainset.
 - i). Low Slack Couplers shall include provisions for separation into halves with each car supporting half the coupler set.
 - ii). Increased inter car stability normally attributed to drawbar or semi-permanent couplers is desired.
 - iii). When separated Low Slack Coupler halves must not require special supports, be damaged or cause damage to the car when left “dangling” from car body connection.
 - iv). When re-joining Low Slack Coupler halves, it is prohibited that new hardware is required.
 - v). It shall not be necessary to utilize external lifting mechanisms for the aligning Low Slack Coupler halves.
 - vi). Method for separation and re-joining of couplers must be presented to Amtrak for review and approval **[CDRL 8-03]**.
 - vii). Gangway support may be provided by the Low Slack Coupler when cars are coupled, however this feature shall not impair uncoupling and re-coupling of cars.
 - viii). Support of intercar wiring and hoses by the Low Slack Coupler is permitted if the time to separate cars is met.
 - ix). Separation and removal of a single car along with recoupling of the train with Low Slack Couplers shall take less than 1 hour, exclusive of time to move cars.
 - x). Adapters for moving separated trainset cars shall weigh less than or equal to 50 lbs. The adapters shall be capable of moving the longest trainset segment minus 1 car at maximum allowable speed.
 - (1) Must able to be installed in the field without a lifting device by a fifth percentile female or ninety fifth percentile male employee.
 - (2) Must have a designated storage location with a minimum of two on each set so that both sides of a separation can be adapted for movement.
 - (3) The movement at maximum authorized speed must be able to operate a full route up to 2100 miles.

8.11 CDRLs

CDRL	Description	Due
8-01	Proposed mounting arrangement for end couplers	During PDR
8-02	Proposed mounting arrangement for intermediate couplers	During PDR
8-03	Method for separation and re-joining of Low Slack Couplers	During PDR

* End of Chapter 8 *

Amtrak Long Distance Bi-Level Fleet Replacement

Technical Specification

9. Brakes

Revision 1

Table of Contents

9.1	Overview.....	9-1
9.2	General Requirements.....	9-1
9.3	Performance.....	9-2
9.4	Design Review.....	9-3
9.5	Car Body Components.....	9-4
9.6	Truck Components.....	9-10
9.7	Wheel Slide Control System.....	9-15
9.8	Brake Indication Devices.....	9-20
9.9	Hand Brake.....	9-22
9.10	CDRLs.....	9-23

9.1 Overview

- a). This chapter describes the design and functionality of the electro-pneumatic and mechanical braking systems that shall be provided on the rolling stock equipment.
- b). The braking systems shall include an electro-pneumatic system for service and emergency brake applications, a wheel slide control system and a parking/hand brake for all cars.
- c). The brake system should be capable of operating in graduated and direct release operation.
- d). All materials and workmanship shall comply with Chapter 19.

9.2 General Requirements

- a). Electronic Brake System
 - i). All cars shall be equipped with a Passenger Electronic 26C Emulation Braking system meeting the requirements of APTA PR-M-S-020-17.
 - ii). The brake system on the cars shall also comply with the requirements of Electronically Controlled Pneumatic (ECP) brake system configured per APTA PR-M-S-021-17.
 - iii). This shall include the installation of trainlines, an electrical terminal box at each end of the car (for installation of the inter-car cabling), a terminal box at the brake manifold, conduit connecting them, as well as armored cable wiring per APTA PR-M-S-022-19.
 - iv). The ends of all cars shall include the ECP inter-car cable and junction connections. Design, arrangement and installation shall be subject to Amtrak approval during design review. **[CDRL 9-01]**
 - v). At a minimum the brake system shall:
 - (1) Be powered by the ECP trainline (when available), by a low voltage source from the car (when available) and a dedicated ECP back-up battery when car battery is not available.
 - (2) Have a discrete means to configure the brake controller for ECP or emulation operation.
 - (3) Incorporate fully pneumatic backup control of emergency brake application, if a malfunction of the electronic brake system occurs, if the car battery is depleted or if no electrical power is present on the car.
 - (4) Accommodate mounting of pneumatics and electronics within a single module or manifold inside of the car.
 - (a) If mounting inside the car is not possible, undercar mounting enclosure shall be sealed from dust, moisture and snow/ice.

- (b) The enclosure shall be shielded from debris damage and its location and arrangement provide easy access for maintenance.
- (5) Incorporate component standardization in accordance with current APTA requirements.
- (6) Use brake control valves meeting the approval of APTA PR-M-S-025-019.
- vi). At all locations where a Type-H coupler is provided, the air brake equipment shall be arranged to be compatible with Type 26C/26L air brake equipment and trainlines as per APTA PR-M-RP-001-97 currently in use in Amtrak passenger service. This is in addition to having complete ECP brake trainline connections, for operation with an ECP-equipped locomotive.
- vii). Nominal air pressures in the air brake system shall be:
 - (1) Main Reservoir: 140 psig
 - (2) Brake Pipe: 110 psig
 - (3) Brake Cylinder: 100 psig maximum
- viii). Each car shall be equipped with a brake pipe for emergency braking to provide break-in-two protection, and a main reservoir pipe.
- ix). All brake components shall be equipped with an identification plate or tag which includes:
 - (1) Vendor
 - (2) Vendor part number
 - (3) Date of manufacture
 - (4) Serial number

9.3 Performance

- a). The system shall be designed for normal and dead-in-tow operation at all speeds up to 110 mph in train consists of up to 4845 ft in total length [excluding locomotive(s)] with propulsion provided by the rail passenger locomotives.
- b). The air brake system shall be designed for normal and dead-in-tow operation in conformance with all applicable Amtrak Air Brake, Equipment and Train Handling Rules and Instructions, specifically AMT-3.
- c). Braking performance shall be in conformance with the braking performance curve as identified for Average Performance Distance (no safety factor) for non-Amfleet equipment operating at 110 mph in Amtrak Drawing S-603.
- d). A trainset of up to 1870 ft in total length built to this Specification and one Amtrak ALC-42 or equivalent locomotive shall have a minimum full-service braking rate of

1.35 miles per hour per second (mphps) at 110 mph increasing to and maintaining an average of 2.00 mphps at speeds of 70 mph or less.

- e). With the trainset loaded to AW2 condition:
 - i). The instantaneous full-service deceleration rate shall not exceed 2.75 mphps nor be less than 1.25 mphps.
 - ii). The emergency brake rate shall not be less than 2.50 mphps at speeds below 70 mph.
- f). The Contractor shall verify that the brakes are fully functional under all operating and environmental conditions found in Amtrak Specification 963.
- g). Locomotive dynamic braking shall not be used to determine compliance with specified brake rates.
- h). The maximum jerk rate (the change in the rate of deceleration) during initial service brake application shall be limited to 1.5 miles per hour per second per second (mphpsps) under all normal conditions.
 - i). There shall be no jerk limit for emergency brake applications.
 - ii). The Contractor shall determine the brake system delay/dead time, build-up time, response time and equivalent deceleration rates for all speeds from maximum speed to full stop.
 - i). This information shall be submitted to Amtrak for review and acceptance during the brake system design review. **[CDRL 9-02]**
 - ii). The Contractor shall use *Mass Transit Brake System - Performance Requirements* per DIN EN Standard 13452-1 as the method to measure dead time response time and deceleration rate where applicable.

9.4 Design Review

- a). Preliminary design review shall address the following subjects, describing Engineer actions and indications and also providing detailed technical design and performance analysis for the following subjects:
 - i). Concept:
 - (1) Concept and operation of friction brake system
 - (2) Thermal capacity of brake system
 - (3) Calculations showing that the system's performance requirements will be met
 - (4) Graduated and direct release setting of control valve
 - (5) Graduated and direct release mode of automatic brake valve operation

- (6) Wheel slide control
- (7) Hand brake interface with brake system, both before and after hand brake application/release, penalty application and automatic brake application as per APTA PR-M-S-006-98.
- (8) Pneumatic supply to accommodate auxiliary systems
- ii). Operating:
 - (1) Push-pull operation with locomotive in either leading or trailing position
 - (2) Push-pull operation with a non-powered control unit
 - (3) Stopping on a grade
 - (4) Starting on a grade
 - (5) Conductor- or passenger-initiated emergency brake application
 - (6) Train separation (break-in-two)
 - (7) Operation of short trains [consists of up to 300 ft in total length excluding the locomotive(s)]
 - (8) Operation of long trains [consists of up to 4845 ft in length excluding the locomotive(s)]
- iii). Design and performance analysis will be evaluated during design review, First Article Inspection (FAI) and proof of design testing. **[CDRL 9-03]**

9.5 Car Body Components

- a). Piping and Fittings
 - i). The inside diameter of the trainline Main Reservoir (MR) pipe shall be 1.00 in. Iron Pipe Size (IPS), or equivalent.
 - ii). The Brake Pipe (BP) shall be 1.25 in. IPS, or equivalent.
 - iii). All pipes and fittings in both lines that are located on the exterior of the trainset shall be 304 stainless steel pipes in accordance with ASTM Standard A-53 or equivalent.
 - iv). Type K copper pipe may be used if located in the trainset interior.
 - v). Brake pipe trainline must pass Brake Pipe Restriction Test per AAR Standard S-471.
 - vi). Brake Equipment Installation and Design shall conform to AAR Standards S-400, and S-401.

- vii). AAR type branch pipe tees, or approved equivalent, shall be provided and shall be orientated at a 45 degree slope upwards or higher to prevent moisture from being drawn into the branch pipes.
 - viii). The trainline MR branch pipe shall be routed to the main reservoir tanks before being routed to the brake manifold.
 - ix). All pneumatic piping shall be routed to avoid traps and avoid draining moisture toward brake valves or brake manifold.
 - x). The low point of the MR pipe shall be equipped with a heated automatic drain valve, to rid the pipe of moisture buildup; moisture drain shall be in response to either brake release cycle or timed cycle.
 - xi). All pneumatic piping shall conform to APTA Standard APTA PR-M-S-029-21.
 - xii). A coalescing filtration system shall be utilized to remove particles and moisture from any portion of the MR pipe before being supplied to the brake system.
 - xiii). The Contractor shall define necessary service inspection and change-out intervals for filters.
 - xiv). Approved test gauge fittings shall be installed in the brake system piping to facilitate testing and troubleshooting the brake system.
 - (1) They shall include all fittings needed for conducting single car brake tests, including the brake cylinder lines to each truck downstream of all cutout cocks.
 - (2) Protective caps shall be provided as necessary.
- b). Angle and Cut-out Cocks
- i). Locking handle, ball type, cut-out cocks shall be provided in the MR Pipe and the BP at each end of every car within the trainset, in a location for ease of access when coupling in restrictive tunnel locations.
 - (1) The BP angle cocks shall not be vented and must include a spring-loaded locking handle.
 - (2) The MR pipe cutout cock shall be vented toward the hose end, oriented below horizontal.
 - (3) The MR pipe cutout must include a spring-loaded locking handle.
 - ii). Each brake manifold shall be provided with a brake pipe cutout cock located for ease of access and simultaneous protection.
 - iii). A locking vented ball-type cut-out cock shall be provided in the brake cylinder line to each axle or truck as appropriate for venting brake cylinder pressure.

- (1) The cutout cock shall be a 3-way type, vented down-stream.
- (2) The vent port of the cut-out cock shall be tapped for 0.25 in. National Pipe Thread (NPT).
- iv). A single Amtrak-approved brake cylinder cutout shall be provided inside the body of each car, requiring use of the standard coach key to access, to be able to vent the brake cylinder pressure on all axles or trucks in emergency or rescue situations.
- v). All cut-out cock handles, except end of car BP end angle cocks, shall be arranged so that the handles are parallel to the air pipe in the closed position.
 - (1) Closed end of car BP cut-out angle cock handle shall be perpendicular to the air pipe.
- vi). Labels
 - (1) All valves and cocks shall be labeled including the cut-in and cut-out positions.
 - (2) A flow bar cast or stamped into cock handles shall be acceptable for cut-in/cut-out position labeling.
 - (3) All air brake angle cocks and cutout cocks are to be clearly labeled using engraved and color-coded stainless steel or aluminum tags.
 - (4) All labels shall be attached using stainless steel banding, wire or adhesive that may not degrade or weaken under normal operating conditions and subject to Amtrak approval.
- c). Hoses and Couplings
 - i). All connecting hoses, except BP and MR trainline hoses, shall be AAR Standard M-618 double wire braid reinforced hose.
 - (1) BP and MR trainline hoses shall be AAR Standard M-601 or M-618 hose.
 - ii). All hose material, when installed on the car, shall be less than one year old from date of manufacture.
 - iii). MR and BP end hoses shall be supported near the glad hand end from the coupler using rubber hose supports.
 - iv). End hose locations shall be in conformance with APTA Recommended Practice PRMRP-001-97 or alternate approaches can be proposed by the Contractor for Amtrak's approval.
 - v). Two dummy couplings, one "F" type and one "E&L" non-vented type, shall be provided at each end of the cars along with one ECP dummy coupling.

- (1) The dummy coupling shall be secured to the trainset with chains in a manner which will prevent the trainline hoses and cables at the ends of the trainset from dragging when the couplings are connected to the hoses and cables.
- d). Emergency (Conductor) Brake Application Valves and Vent Valves
- i). Manually operated conductor's valves shall be provided as follows:
 - (1) On both ends of the passenger compartment of each trainset car section, just inside the body end door, right side of the door facing outward.
 - (2) At least two conductor's valves shall be provided per the equivalent length of the cars, but they must be provided adjacent to any inter-car doors.
 - (a) Conductor's valves shall be provided on each level on each end of the passenger car.
 - (3) Ensure no fouling condition in both application and resetting function of conductor valves.
 - (4) The valves shall be located in a conspicuous location for ease of operation.
 - (5) Valves shall not be blocked by any doors or access panels when they are opened.
 - (6) The operating handles shall be red and shall be clearly labeled, in accordance with Amtrak Specification 696, and shall not rattle when in service.
 - ii). These emergency brake valves, when used in conjunction with an appropriate brake application valve, shall cause an emergency brake application when activated.
 - iii). The diagnostic system shall have the ability to report which car on the train initiated the emergency brake valve.
 - iv). Vent valves shall be provided along the BP in accordance with air brake system design requirements based on brake pipe length and control manifold locations.
 - v). Ready access shall be provided to all valves to facilitate inspection, replacement and maintenance.
 - vi). The valves shall meet the requirements of APTA Standard PR-M-S-007-98.

- e). Air Reservoirs
 - i). Reservoirs of sufficient capacity shall be provided to enable a minimum of three full-service brake applications and releases followed by an emergency brake without recharging.
 - ii). Check valve isolation requirements must be demonstrated for dedicated reservoirs.
 - iii). ASME-certified main and auxiliary (brake cylinder) supply reservoirs shall be drilled with telltale holes as described in 49 CFR Part 229 to eliminate the need for hammer and hydrostatic testing.
 - iv). When installed, they shall include a manually operated ball valve with locking handle to drain any accumulated moisture.
 - v). The reservoir shall not have volume accessible to fluid below the plane of the purge valve inlet.
 - vi). All valves shall be easily accessible from the side of the car.
 - vii). Main reservoirs and air supply reservoirs used for water raising or other auxiliary functions shall be coated internally with a suitable paint to prevent corrosion.
 - viii). All reservoirs shall be welded and shall comply with the ASME *Boiler and Pressure Vessel Code* as applicable.
 - ix). Air reservoirs shall be sloped if drain valves are located at end of the tank.
- f). Control Manifold and Valves
 - i). The service portion shall provide the functionality equivalent to a Type 26C service portion and shall be manifold mounted.
 - ii). The air brake control manifold valve may be mounted underfloor.
 - iii). Branches will leave the brake pipe at a 45-degree slope upwards or higher and shall utilize an AAR "branch pipe tee", or approved equivalent.
 - iv). Brake Pipe shall be filtered by use of combined dirt collector cutout cock with filter or panel mounted filter before connection to brake valves.
 - v). The air brake control manifold shall at a minimum include test fittings for main reservoir, brake pipe, brake cylinder and #16 air pipes.
 - vi). In addition, the relay valve exhaust shall have a threaded exhaust outlet to permit mounting a gauge.
 - vii). Full-face gaskets or O-ring gaskets shall be used for valve portion interface sealing.

- viii). All stud mounted components shall be designed to allow installation or removal with standard socket wrenches by a single person.
 - ix). Electronic modules, pneumatic modules, cutouts, test points and electrical connections shall be front-plate mounted on the manifold.
 - x). Front-plate mounting is not required if the manifold is oriented so that access is provided to both sides.
 - xi). All power, input and output connections, external to the manifold, shall be provided with multiple pin connectors or a screw-type terminal block with a rating of IP 68.
 - xii). Individual spade-type or threaded connectors are not permitted.
 - xiii). Ring terminals shall be used if connected to a screw-type terminal block.
 - xiv). All valves on the manifold, as well as the manifold itself, shall be easily removable for servicing.
 - xv). All valves shall be individually replaceable with the manifold installed on the car without removing any additional valves or components.
 - xvi). All air brake system components which are subject to scheduled, regulated maintenance shall be serialized.
 - xvii). Valves shall be acoustically isolated from the passenger car interior areas to minimize exposure of passengers and crew to noise generated by the air brake components.
 - xviii). Exhausted air shall be piped to the underside (exterior) of the trainset.
 - xix). All valves that have an exhaust port shall be equipped with a wasp excluder.
 - xx). Brake cylinder pressure shall be supplied and maintained by a relay valve with a 1:1 ratio, or approved equivalent.
 - xxi). All devices shall be clearly and permanently labeled on the manifold body, including cut-in and cut-out positions of all valves and cocks.
 - xxii). Etching or silk screen printing during the machining process is acceptable for labeling manifold items.
 - xxiii). Full service brake and emergency brake cylinder pressure shall be sufficient to achieve the required brake rates.
- g). Auxiliary Air Equipment
- i). MR air will be used for air-operated auxiliary devices.
 - ii). BP air shall not be used.

- iii). Auxiliary functions shall be isolated from air brake functions and shall be disabled when MR pressure falls below 80 psig.
- iv). Adjustable-setting auxiliary valves with governors shall regulate air pressure for MR-supplied functions such as water raising and toilets.
- v). Cutout cocks and pressure test ports shall be provided for each auxiliary system.
- vi). All water raising, or waste system air valves shall be mounted above the water level of the storage tank to prevent backflow of water into the air system during normal operation or when the air system is depressurized.
 - (1) Appropriate check valves will also be used to ensure this functionality.
 - (2) The valves shall be readily accessible for maintenance and replacement.

9.6 Truck Components

a). General

- i). All cars shall be equipped with a combination of disc and tread brake equipment.
- ii). The brake cylinders for both the disc brakes and/or the tread brakes shall operate at the same air pressure from the same air source.
- iii). Brake effort contributions from disc and tread brakes shall be specified to avoid wheel thermal cracking and brake disc damage.
- iv). Under all circumstances the brake rates defined in this Chapter and in this Specification shall be achieved.
- v). The truck-mounted components as specified have been identified for the purposes of interchangeability with other long distance passenger cars.
- vi). The Contractor may propose alternate components for Amtrak approval if the components as specified cannot achieve the specified braking rates or if superior braking performance can be achieved through the use of other brake system components or based on the car design constraints.
- vii). The truck brake equipment and general car arrangement shall facilitate ease of access for disc brake pads and tread brake shoe replacement at remote yard locations, without the need for a servicing pit.

b). Disc Brake Actuator

- i). Caliper Assembly
 - (1) An air actuated caliper mounted on the truck frame shall be used in conjunction with each disc to develop braking effort.

- (2) Suspension of caliper assembly shall be a 3-point position type or a compact caliper that permits caliper to follow lateral movement of the wheel assembly without restriction.
- ii). Slack Adjusters
 - (1) Automatic slack adjusters shall have sufficient capacity to maintain nominal pad clearance and piston travel through the full range of new to worn discs and brake pads.
 - (2) The slack adjuster shall have sufficient capacity to maintain nominal shoe clearance and piston travel through the full range of new to worn discs and brake pads.
- iii). Brake Pads
 - (1) The disc brake system shall use pads compliant with Amtrak Specification 973 and approved during Design Review.
 - (2) The disc brake units shall be capable of using 35mm thick brake pads if possible.
 - (3) Performance of brake disc friction material shall be suitable for the speeds, route brake duty cycle and overall train braking performance and shall not induce temperatures that may result in long or short term thermal damage to the disc friction ring as defined by brake disc manufacturer.
 - (4) Pad holders and disc pads shall have an approved locking device.
- iv). The disc actuator shall be capable of handling pressure up to 150 psig without damaging the actuator, disc, brake rigging or any other system or component on the vehicle.
- c). Brake Discs
 - i). The number of brake discs per axle and the type of brake disc (axle or wheel mounted disc) shall be sufficient to meet the brake rates specified herein and not exceed the thermal rating of the disc or pads.
 - ii). Brake disc supplier shall provide an analysis of the thermal capacity of the discs based on the planned train operational pattern including frequency of braking for various braking initial speeds and station stopping patterns as provided by Amtrak. **[CDRL 9-04]**
 - iii). In the design of axle mounted discs, the fatigue life of the connection between the hub and friction ring must take into account cyclic loading from thermal and shock environments that are separately considered and are encountered in normal service.
 - (1) The shock environment due to wheel/rail interaction at normal revenue speeds is known to result in disc response in the form of a “bending out of plane” vibrational mode.

- (2) The natural resonance frequency of the disc, for this bending mode, shall be demonstrated (by analysis or test) to be greater than 350 Hz. **[CDRL9-05]**
 - (3) The frequency analysis is to be performed under the assumption that the disc is fixed to the axle or wheel.
 - (4) The fatigue life at the most highly stressed location in the connection between the hub and spoke, due to combined strains from thermal and shock load, shall be equal to or greater than the projected service life of the friction ring or 1,000,000 miles, whichever is greater.
- iv). All brake discs shall be manufactured by an Amtrak-approved facility with a history of successfully supplying railway brake discs.
 - v). Disc characteristics compliant with the requirements of this Chapter shall be demonstrated during design review.
 - vi). The brake disc supplier shall initially investigate if the brake disc currently used by Amtrak for a F-size axle is suitable for this application.
 - vii). Brake Discs shall be implemented with wear indicators that can be viewed from the car exterior in order to track wear using wayside video and data monitoring.
 - viii). Design Criteria
 - (1) The brake discs (including friction ring and spokes) shall have adequate mechanical and thermal capacity for service on and off the Amtrak Northeast Corridor (NEC), under the environmental and operating conditions identified in Amtrak Specification 963.
 - (a) The discs shall be designed to withstand the mechanical loads arising from track-generated accelerations and thermal loading from friction braking from initial installation through the projected service life of the disc friction ring.
 - (b) This shall be verified by Finite Element Analysis (FEA) per Section 9.6.c.ix) and a fatigue life estimate **[CDRL 9-06]** based on the results of the analysis performed by the brake disc supplier and shall be submitted to Amtrak for review and acceptance.
 - (2) An analysis shall be conducted to predict the fatigue performance of the proposed brake disc from the thermal loading measured from the dynamometer testing performed pursuant to the requirements of Chapter 20 and submitted to Amtrak for approval.
 - (3) For mechanical loading, each shock event shall translate into a minimum of two full bending stress reversals when evaluating the fatigue life of the disc, to account for the damping of the excitation in the disc.

- (4) A moment arm shall be taken into account for the distance from the axle box to the center of the disc for vertical shock loads, based on the worst case condition.
 - (5) The fatigue analysis of the disc shall take into account fatigue damage from in-service thermal and mechanical loading combined.
 - (6) The fatigue limit shall be selected based on at least a 50% probability of survival and shall account for manufacturing technique, surface finish, metallurgical properties, etc. as specified in recognized industry standards.
 - (a) The factor of safety shall be at least 1.50.
 - (b) The factor of safety shall be applied to the stresses obtained from the FEA which are incorporated in the fatigue estimate to reduce the predicted fatigue life.
- ix). Brake Disc FEA Report
- (1) The brake disc supplier shall submit a brake disc FEA report, for approval by Amtrak. **[CDRL 9-07]**
 - (2) The maximum stress from the FEA at the specified loads, with a factor of safety of at least 1.50, shall be less than the allowable fatigue limit.
 - (3) The Contractor may elect to simplify the load cases into stepped increments, provided the methodology and the data utilized to establish equivalency is found acceptable to Amtrak.
 - (4) The FEA report must include an analysis for fatigue life and must include a Miner's rule calculation showing the damage factors due to loads imposed by vertical and lateral axle box acceleration and thermal loads resulting from friction between the disc and brake pads.
 - (a) The Miner's sum must not exceed 0.3 for the service life of the disc for the hub-friction ring connection.
 - (5) The FEA report shall include, but not be limited to, the following:
 - (a) Introduction
 - (b) Table of Contents
 - (c) Summary
 - (d) Physical properties of each material used for the disc.
 - (i) This table shall include, but not be limited to:
 1. Yield strength
 2. Ultimate strength

3. Elongation
 4. Tension modulus
 5. Compression modulus
 6. Shear modulus
- (ii) Minimum values shall be used and shall be selected from ASTM (or equal) material specifications, as approved by Amtrak.
 - (iii) The brake disc supplier may propose alternate material specifications for Amtrak approval.
- (e) Views of key structural areas (spokes, hub-friction ring connections, etc.) showing member locations and geometry, and indicating the material and thickness of each.
- (i) Other FEA views may be required where critical stress areas are identified.
- (f) A tabulation or fatigue curve justifying the Contractor's selection of allowable fatigue stresses for the disc material for each transition or joint, and the fatigue-critical stress ranges.
- (i) The FEA report shall include a description of how this process is carried out.
- (g) The complete test report must be submitted including procedure, raw and reduced data, and summary of results, including:
- (i) Structural sketches and/or layouts of the critically stressed locations showing locations and shapes depicted in scale, thickness, section properties and material. Methods of joining (if appropriate) shall be defined.
 - (ii) Diagrams displaying externally applied loads and boundary conditions.
 - (iii) Color plots of the stress under each load condition for critically stressed areas.
 - (iv) Natural Frequencies of the disc.
- d). Tread Brake Units
- i). Tread brake units shall be added to the trainset to supplement disc braking.
 - ii). A truck mounted air actuated tread brake unit, with integral single acting slack adjuster shall be applied at each wheel.

- iii). The tread brake unit shall operate in conjunction with the adjacent disc brake caliper from the same air source.
- iv). Composition brake shoes 2.5 inch thick, of a size and type in general use by Amtrak and conforming to Amtrak Specification 80-276 shall be provided.
- v). Performance of brake shoe friction material shall be suitable for the speeds, route brake duty cycle and overall train braking performance and shall not induce temperatures at the wheel tread that may result in long or short term thermal damage, as defined in 49 CFR Part 238.
- vi). A brake key inserted from the top of the brake head shall secure the brake shoe to the brake heads and shall not require the use of specific tools for installation or removal.
- vii). The design of the tread brake shall accommodate the maximum allowable size wheel with sufficient clearance for operation and maintenance.
- viii). The slack adjuster shall have sufficient capacity to maintain nominal shoe clearance and piston travel through the full range of new to worn wheels and brake shoes and shall provide sufficient clearance to install a 2.5 in. brake shoe against a new wheel.
- ix). Should tread brakes not be required the Contractor shall install enough wheel scrubbers to condition the wheels and ensure adequate ground between wheel and rail.

9.7 Wheel Slide Control System

a). General

- i). The wheel slide control system shall modulate the application of the pneumatic brakes to prevent sliding of the wheels through the use of a microprocessor design. The system for each wheel location shall include:
 - (1) System unit/controller with pre-wired connector plugs
 - (2) Modulation type dump valves as required
 - (3) Molded T-harness cable, or equivalent protected cable type as required
 - (4) Speed sensors (one per axle or wheel location)
 - (5) The ability to perform wheelslide system diagnostics with a laptop Portable Test Unit (PTU) (test unit itself is not required) and by the car CCU (if equipped).
 - (6) Adapter cable to connect a PTU to the wheelslide control unit
 - (7) Wheel Slide Control may be incorporated into the ECP controller with the approval of Amtrak

- ii). The system shall continuously measure the speed of each axle/wheel and take corrective action should a sliding wheel be detected.
 - iii). The wheel slide system shall operate under all braking conditions and shall not permit the jerk limit to be exceeded on reapplication of brakes following a slide correction.
 - iv). The system shall be designed to prevent permanent thermal damage to the wheel tread as evidenced by spalling, under all adhesion conditions.
- b). Control Unit
- i). The control unit shall not be mounted under the car unless approved by Amtrak.
 - ii). The wheelslide control equipment is subject to the following conditions:
 - (1) The wheel slide function shall be automatically self-calibrating to continuously adjust for the difference in wheel circumference from nominal new wheel to fully worn wheel rim thickness.
 - (2) The system software shall be designed to account for the rotational inertia properties of the wheel set assembly.
 - (3) Wheel slide corrections shall not occur at normal deceleration rates on dry, level tangent track.
 - (4) System logic and criteria for detection and correction of wheel slide and instantaneous deceleration rate shall be submitted for review and approval. **[CDRL 9-08]**
 - (5) The system software/control electronics shall possess features to prevent inappropriate wheel slide correction function from transient signals arising from one damaged or missing gear tooth.
 - (a) This requirement includes provisions for intelligent interpretation of transient changes in signal amplitude at all speeds due to axle gear run-out, vibration of sensor mounting bracket or sensor/gear clearance settings.
 - (b) Wheel slide protection shall be retained on all remaining axles should the control unit fail to receive one or more axle speed signals.
 - (c) It is recognized that the system performance for the axle with the defective sensor is compromised under these conditions.
 - (6) A safety timing function meeting the requirements of EN Standard 50126 SIL 3 shall be provided to cancel wheel slide corrections exceeding a specified duration to be determined based on final system design.

- (a) Protection shall be locked out on the affected axle/truck until car is at zero speed.
- (7) The system shall utilize software that is at the current revision at the time of installation.
- iii). Auxiliary Functions
 - (1) The system shall supply at least two auxiliary speed signals, provided for door control, as described in Chapter 12, as follows:
 - (a) A zero-speed switching device shall close below 3 mph, and shall open above 3 mph.
 - (i) The device shall have an auxiliary set of both normally open and normally closed contacts.
 - (b) A 20 mph speed switching device shall close below 20 mph and shall open above 20 mph.
 - (2) Logic shall be fail-safe, such that zero-speed and 20 mph relay drop out in the event of any component failure or loss of power.
 - (3) Speed signal logic shall meet the requirements of EN 50126 SIL 2.
 - (a) The speed signal shall incorporate separate relays that break both the positive and negative components of the zero and 20 mph signals.
 - (b) Both the normally open and normally closed contacts shall be made external to the unit.
 - (c) Contact rating shall be at least 2.0A at 80VDC.
 - (d) Contacts shall be high reliability to reduce the probability of welding.
- iv). Diagnostics
 - (1) The wheelslide control unit shall include integral diagnostic indications (at a minimum) of the following system states with the vehicle moving:
 - (a) Open, shorted or grounded speed sensor circuit
 - (b) Open, shorted or grounded dump valve circuit
 - (c) Electronics fault identified at component level
 - (d) Power loss/low supply voltage during car deceleration
 - (e) Software logic fatal error or program lockup
 - (f) Time out of safety timer

- (g) Weak/missing speed sensor signal
- (h) Logging capability for running total of slide corrections
- (i) Locked axle
- (2) When the car is stationary with adequate power and air, it shall be possible to conduct a self-test that shall verify the following functions in addition to those above:
 - (a) Ability of magnet valves to release and apply brake cylinder pressure
 - (b) Ability to test magnet valve time-out
 - (c) Ability to exercise speed condition relays
- (3) The diagnostic information listed in Diagnostics and Faults shall interface with the car diagnostic system and shall be accessible remotely.
- (4) Diagnostics, faults, and instances of slide corrections shall be capable of remaining in stored memory for no less than 3 months and shall continuously overwrite the oldest data with the newest.
- (5) Additional details regarding diagnostic functionality are included in Chapter 24.
- v). Faults
 - (1) Faults detected shall be retained in the fault memory and displayed on the front of the controller using a numerical display that indicates proper system operation, or a fault code. The readout shall:
 - (a) Be able to identify defects down to printed circuit board or module, individual speed sensor or dump valve level.
 - (b) Include transient faults detected while the car is in motion.
 - (c) Provide sufficient information to enable maintenance personnel to determine if the unit is working properly, and if not, whether the system can be repaired while on the car or must be removed for repairs.
 - (2) A permanent label shall be fixed to or near the wheel slide control unit that identifies the codes for faults represented by the display.
 - (a) It shall also provide instructions for initiation of self-test program and the clearing of faults from memory.
 - (b) The chart shall be positioned so that it can be easily referenced in seated or standing position (as appropriate) while reading the display or manipulating button.

- vi). Components
 - (1) All components shall be identified with:
 - (a) Vendor name
 - (b) Vendor part number
 - (c) Date of manufacture
 - (d) Revision level
 - (e) Serial number
- vii). Test Equipment and Software
 - (1) The Contractor shall provide a minimum of five electronic copies of wheelslide system diagnostic software to be used on a PTU. **[CDRL 9-9]**
 - (a) Operating instructions for this software shall be included in the vehicle maintenance manuals.
 - (2) The Contractor shall provide Amtrak with a minimum of 10 cable sets, no less than 8 ft in length, to connect a PTU to the wheelslide control unit to allow on-car troubleshooting. Vendor and vendor part number shall also be provided. **[CDRL 9-10]**
 - (3) These quantities may be modified by Amtrak as denoted in Chapter 21.
- c). Dump Valves
 - i). When a slide condition is detected by the wheel slide control unit, it shall be relieved on a per truck/per axle basis, by controlled reduction of brake cylinder pressure by an electro-pneumatic modulating type dump valve.
 - ii). Braking shall be reapplied after correction is made at a rate designed to take maximum advantage of prevailing adhesion without exceeding the jerk rate.
 - iii). Air consumption shall be minimized during slide correction.
 - iv). The dump valve porting and internal capacity shall be optimized for car dead and displacement brake cylinder volumes.
 - v). The manufacturer must provide a pre-wired mating plug connector for each dump valve.
 - vi). The wire pigtail must be molded construction and sealed at the plug.

d). Speed Sensors and Wiring

- i). Axle/wheel speed shall be determined from an active speed sensor mounted on a journal bearing adapter and a toothed gear mounted on the axle.
 - (1) The sensor shall detect all speeds down to 0 mph.
- ii). Speed sensor shall be mounted to the journal bearing housing or adapter at a fixed depth to achieve nominal air gap between toothed gear and speed sensor under all operating conditions.
- iii). The speed sensors shall connect to the wheelslide control unit through a T-harness, or equivalent protected cable system.
- iv). The T-harness or equivalent protected cable system shall connect to the carbody wiring through a MIL standard circular connector, mounted to an electrical box on the carbody.
- v). Terminal and junction boxes shall not be mounted on the trucks.
- vi). The speed sensor cables and T-harness, or equivalent protected cable system, shall be attached to the truck frame, or equivalent, using coated clamps that provide secure attachment while not abrading or pinching the cable.
 - (1) Each clamp shall secure no more than one cable.
- vii). Clamps shall be attached to the truck frame, or equivalent, using fasteners and lock washers.
- viii). There shall be sufficient slack in the speed sensor wiring to allow the bearing adapter to move to the bottom of the pedestal opening without stressing the cable (such as when the truck is lifted with axles installed).
- ix). Cables and harnesses shall be accessible for replacement while the trainset is at a normal service and inspection facility.
- x). Mounting and wire routing of all truck components shall be arranged to minimize the exposure to wayside debris damage.

9.8 Brake Indication Devices

a). Indicators

- i). Indicators, one on each side of the trainset at each truck or axle, shall be connected to the brake cylinder supply line between the brake cylinder cut-out cock and the brake cylinder.
- ii). These indicators shall provide a positive visual status of the brake system to crew members.
- iii). The indicators shall be readily visible from station platforms as well as track level, and from both ends of each side of the car.

b). Pressure Switches and Brake Status Lights

- i). A pressure switch shall be provided for each truck or axle, monitoring the brake cylinder pressure downstream of the truck or axle cutout cock.
- ii). A test fitting shall be provided in each brake cylinder line to the trucks/axles, downstream from cutout cock and dump valve.
- iii). In addition, a test fitting shall be provided for each pressure switch to check calibration. These pressure switches operate the brake applied/released indicator lights.
- iv). Trainline function is as follows:
 - (1) Brake released: continuity when failing brake cylinder pressure on both trucks reaches pressure where internal spring forces of brake cylinders release the brakes and the handbrake released.
 - (2) Brake applied: continuity when rising brake cylinder pressure on both trucks is achieved at a "Min" brake application or greater or the handbrake is applied.
- v). The exterior of each trainset adjacent to the air brake control manifold shall be equipped with two 3-lamp LED indicator assemblies, as specified in Chapter 13.9.e).iii).
- vi). Indicators shall display the following aspects, top to bottom:
 - (1) Solid Green: All service brakes released
 - (2) Solid Yellow: Service brakes applied
 - (3) Flashing Yellow: Handbrake applied (with air brakes applied or released)
- vii). For handbrake applications, a weatherproof micro-switch or pressure switch shall be provided to indicate handbrake status to the car's exterior brake status lights, and to the locomotive via the 27point communication trainline and the digital trainline.
 - (1) The switch shall be weatherproof to prevent damage from environmental conditions.
- viii). For spring brake applications, a pressure switch monitoring the pneumatic control circuit of the spring brake mounted downstream of any anti-compounding device shall be provided.
 - (1) The switch shall indicate spring brake status to the car's exterior brake status lights, and to the locomotive via pin 20 of the 27-point communication trainline and the digital trainline.
 - (2) The switch shall be weatherproof to prevent damage from environmental conditions.

- (3) The set point of the pressure switch shall indicate when full spring effort is applied (pressure < 5psi).
- ix). Alternatively, an integrated car diagnosis could be implemented. An electronic monitoring computer in certain areas of the car could allow a full diagnosis of all the car axles brake status from only one point.
- x). A pressure transducer or pressure switch monitors the brake cylinder pressure downstream of each truck or axle cutout cock. Output from those pressure measuring devices will be routed to car electronics, and from there to the monitoring centers in the car via communication car buses. In parallel, brake pressure indicators will be maintained on the exterior of the trainset. Communication trainlines will provide the same functionality.

9.9 Hand Brake

- a). A handbrake with lever type handle shall be provided at the B-end wall, upper level.
- b). A sufficient number of wheels shall be equipped with handbrakes, such that compliance with APTA Standard PR-M-S-006-98 is achieved.
- c). The handbrake shall be capable of holding AW3 loaded car, on a 5%grade, with an applied force of 125 lbs. 3 inches from the end of the handle under all normal truck wear (tread, wheel and brake shoe) conditions.
- d). Operating instruction labels shall be provided for the train crew regarding manual operation and rescue operation when normal air or electrical supplies are disrupted. These shall be provided at the control location and also at the ends of the trainsets.
- e). Application of the Hand Brake shall be provided by a visual indicator for when the car is without power.
 - i). The status of the Hand Brake shall be communicated to the locomotive cab via the 27 point communication trainline. The switch shall have two (2) sets of form C contacts, minimum rating .22A @ 120VDC.
- f). Hand Brake linkage shall connect the Hand Brake operator to the tread brake unit. It shall not rattle during car motion, and design shall ensure that it does not inhibit proper operation of the slack adjusters.

9.10 CDRLs

CDRL	Description	Due
CDRL 9-01	Design of ECP brake system inter-car cable and junction connection	30 days prior to Brake System PDR meeting
CDRL 9-02	Brake system delay/dead time, build-up time, response time and equivalent deceleration rates for all speeds from maximum speed to full stop.	30 days prior to Brake System IDR meeting
CDRL 9-03	Brake System design and performance analysis	30 days prior to Brake System IDR meeting.
CDRL 9-04	Disc Brake Thermal Capacity Analysis from supplier	30 days prior to Brake System IDR meeting
CDRL 9-05	Brake Disc Natural Frequency Analysis	30 days prior to Brake System IDR meeting
CDRL 9-06	Brake Disc Fatigue Life Estimate	30 days prior to Brake System IDR meeting
CDRL 9-07	Brake Disc FEA Report	30 days prior to Brake System IDR meeting
CDRL 9-08	Wheel Slide System Detection Logic and Criteria	30 days prior to Brake System IDR meeting
CDRL 9-09	Wheelslide System Diagnostic Software (5 electronic copies for PTU)	With Pilot Trainset Delivery
CDRL 9-10	Wheelslide PTU Connection Cables (qty. 10 minimum)	With Pilot Trainset Delivery

* End of Chapter 9 *

Amtrak Long Distance Bi-Level Fleet Replacement

Technical Specification

10. HVAC System

Revision 1

Table of Contents

10.1	Overview	10-1
10.2	Design Parameters.....	10-4
10.3	Comfort Requirements	10-5
10.4	Air Conditioning	10-8
10.5	Heating.....	10-11
10.6	Ventilation	10-15
10.7	Fresh Air Dampers	10-19
10.8	Controls.....	10-20
10.9	Accessibility and Maintainability.....	10-25
10.10	CDRLs.....	10-27

Table of Figures

Figure 10-1:	Cooling System Design Parameters.....	10-4
Figure 10-2:	Heating System Design Parameters	10-4
Figure 10-3:	Required Interior Vehicle Temperatures.....	10-5
Figure 10-4:	Maximum Noise Levels	10-7
Figure 10-5:	Temperature Control Positions.....	10-22

10.1 Overview

a). General

- i). Each car in every trainset shall be equipped with two interchangeable independent HVAC units to provide heating, ventilation and air conditioning to the car, along with the overhead and convection heaters evenly distributed in the vehicle interior.
- ii). The HVAC units shall be easily removable and self-contained and shall utilize scroll compressors using an US EPA approved refrigerant for cooling that is not associated with a date to be retired at the time of NTP.
- iii). The exterior of the unit shall not have any handles, flanges or other drag- or noise-inducing features or edges that project above the outline of the unit.
- iv). The unit design shall provide a seamless integration with the car shell design and complement the contour and aesthetic appearance of the vehicle.
- v). The HVAC units shall supply a ceiling-mounted main air distribution duct capable of supplying all air diffusers along the length of the car.
- vi). In the event of a failure of one of the HVAC units, the ducting shall be capable of providing limited air supply throughout the entire car whether through automated dampers or split ductwork.
- vii). Dampers on the fresh air intake vents shall control the amount of outside air taken in by the HVAC system.
- viii). Heating shall be provided by forced air heating in the HVAC units to temper fresh air, and by sufficient convection heating units in the vehicle interior to meet the performance requirements of Section 10.3 and Figure 10-3.
- ix). Temperature control shall be provided by a microprocessor based integrated HVAC control system that monitors outside and inside temperatures and adjusts the system's cooling and heating functions to maintain a comfortable inside temperature and humidity level throughout the range of environmental and climatic conditions identified in Amtrak Specification 963.
- x). Activation of the HVAC system on each car shall be under the control of the train crew.
- xi). Freeze protection shall be provided at a minimum to the side doors and all freshwater system components that may be exposed to freezing conditions.
- xii). Freeze protection systems will be controlled and monitored through the HVAC controller and shall be dependent on ambient temperature.

b). Design Requirements

- i). The HVAC system shall provide a comfortable temperature-controlled environment in all interior areas of the trainset as follows:

CONFIDENTIAL — DO NOT DISTRIBUTE

- (1) The trainset shall be designed to operate in all environmental and climatic conditions identified in Amtrak Specification 963.
- (2) The HVAC system components shall be service proven and supported by design and test information to demonstrate compliance with the Contract requirements.
- (3) The floor heat shall be independently controlled, with potentially different approaches for open-body and compartmented car types.
- (4) Passenger loads shall be assumed to be AW2 for cooling load calculations.
- (5) ASHRAE standards for passenger and solar heat load will be used.
- (6) Heating and cooling requirements shall simulate passenger loading and unloading as follows in all outside ambient temperatures identified in Amtrak Specification 963:
 - (a) This shall include the opening of all sets of side doors on alternating sides of the vehicle every 30 minutes, with the doors held open for 2 minutes each time.
- (7) Ambient conditions as specified and heat losses due to train motion shall be included in HVAC system performance evaluation.
- (8) Air losses due to door and carbody leakage shall be included in the HVAC system performance evaluation, including the temperature gradient end to end of the car (one end hot and one end cold).
- (9) Supply air flow shall be balanced to provide even distribution throughout all occupied areas of the car as well as food service areas, crew rest areas, and baggage storage areas.
- (10) Dampers on the fresh air intake vents shall control the amount of outside air taken in by the HVAC system.
- (11) Freeze protection shall be provided and turned on when the ambient outside temperatures drop below 45°F, and shall shut off when the outside temperatures rise to 50°F.
- (12) The Contractor shall prepare, and submit for Amtrak's approval during design review, a detailed heating and cooling load analysis along with recommended heating, cooling and ventilation capacities of all car types. **[CDRL 10-01]**
- (13) The HVAC unit manufacturer shall conduct qualification testing to verify the heating and cooling capacity of the unit per ASHRAE Standard 37-2009 and to verify the design approved by Amtrak.
- (14) Power

- (a) Power to the HVAC system and controls shall be from the following supplies:
 - (i) HVAC system: 480VAC, 3-phase, 60 Hz supply
 - (ii) Temperature controls: 72VDC
 - (iii) Freeze protection circuits: 120VAC, 1-phase, 60 Hz supply
 - (b) Alternate supply voltages may be proposed to Amtrak for approval.
 - (c) The HVAC system shall be designed to perform at the nominal voltages and operate within the voltage and frequency tolerance ranges specified in Amtrak Specification 963.
 - (d) To minimize the effects of motor inrush currents on the head end power system, the controls on each car shall incorporate a soft start or a method to provide randomly staggered starting of the refrigerant compressor motors in the trainset.
 - (i) Control scheme shall be submitted for review and approval. **[CDRL 10-02]**
 - (e) HVAC system circuit breakers, temperature display, fault detection and protection, and status indicator screen shall be located in the electrical locker and shall be accessible only to the operating and maintenance crews.
 - (f) Circuit breakers, controls and relays shall be inaccessible to the passengers.
- (15) Temperature controls shall be reliable and maintain car temperature at desired values.
- (16) The control system(s) shall not shut down by themselves and require manual reset. All connectors shall be rated to an IP rating of IP68 or better.
- (17) The HVAC unit shall utilize a scroll compressor using an US EPA approved refrigerant for cooling, hermetically sealed, without threaded components, or other non-brazed fittings, except for service ports (high and low pressure and, if required, charging port).
- (18) Pressure transducers shall be provided to allow the microprocessor to monitor both the discharge and suction line pressures.
- (a) This information shall be available to technical personnel for troubleshooting purposes.

- (19) The performance of the entire assembled HVAC system as installed in a completed trainset car, or cars, if necessary, shall be verified at the climate room test.

10.2 Design Parameters

- a). The following parameters are to be assumed in the design of the cooling system:

Figure 10-1: Cooling System Design Parameters

Ambient Temperature	110°F Dry Bulb/76°F Wet Bulb, with 120°F air entering the condenser
Solar Load	Based upon worst case conditions in Phoenix, AZ in accordance with ASHRAE calculation methods. All window options shall be considered for solar loading.
Passenger Heat Load	440 BTU/hr/person at a heat ratio of 0.60
Number of Passengers	85 seated passengers per 85 ft of trainset length (load level AW2)
Carbody Heat Transmission	In accordance with the Contractor's carbody insulation design to meet the requirements of this Specification, but not greater than 1200 BTU/hr-F° for standard car length of 85 ft
Minimum Fresh Air	12 Cubic Feet per Minute (cfm)/seated passenger, with 9cfm/seated passenger permitted at outside temperatures above 100°F.
Other Heat Loads	Normal vehicle lighting, electrical equipment and appliance loads

- b). The following parameters are to be assumed in design of the heating system:

Figure 10-2: Heating System Design Parameters

Ambient Temperature	-30°F Dry Bulb
Carbody Heat Transmission	In accordance with the Contractor's carbody insulation design to meet the requirements of this Specification, but not greater than 800 BTU/hr-°F for stainless steel, or 1600 BTU/hr-F° for aluminum.

Minimum Fresh Air	12 Cubic Feet per Minute (cfm)/seated passenger, with 9cfm/seated passenger permitted at outside temperatures below 0°F.
--------------------------	--

- c). The city of Chicago, IL should be considered for worst case heating load requirements and the city of Phoenix, AZ should be used for cooling load calculations.

10.3 Comfort Requirements

a). Interior

- i). The following temperatures shall be maintained within the car, including toilet rooms when the associated ambient outside temperatures are present:

Figure 10-3: Required Interior Vehicle Temperatures

Outside Ambient	Interior Vehicle Temperature
Below -30°F	As system will provide
-30°F to +60°F	70°F ± 2°F (±4°F for toilet room)
60°F to 110°F	72°F ± 2°F (±4°F for toilet room)
Above 110°F	As system will provide, but no less than 30°F below outside temperatures up to 130°F.
Layover Heat Mode	50°F ± 5°F (±4°F for toilet room)

- ii). During all modes of air conditioning, the interior relative humidity shall not exceed 55%.
- iii). Except within the area of the side doors and vestibules, the HVAC system shall maintain a temperature variation of the following:
 - (1) Vertical Variation:
 - (a) On any vertical line, 4 in. above floor to 43 in. above floor, not closer than 12 in. from walls, and not closer than 20 in. from doors:
 - (b) 3°F maximum difference between end points of the vertical line.
 - (3) Horizontal Variation:
 - (a) On horizontal planes measured 4 in., 43 in. and 67 in. from floor, not closer than 12 in. from walls and not closer than 20 in. from doors:

- (b) The temperature at any point within each plane should not exceed $\pm 3^{\circ}\text{F}$ from the average temperature in that plane.
 - iv). The average trainset car temperature shall recover within 2°F of the required interior vehicle temperature within three minutes maximum following a two-minute door opening of all doors on one side of the trainset.
 - (1) It shall be demonstrated that this requirement can be met during two hours of continuous door cycling on alternate sides of the vehicles of five minutes open and 15 minutes closed at the design conditions in both heating and cooling modes.
 - v). The bi-level equipment design provisions shall mitigate any impact to the upper level when the lower level carbody doors are open.
 - vi). When the car interior temperatures are within the ranges specified, the air temperature differential between the car interior and the air leaving the diffuser at the slot outlets shall not be greater than 25°F .
- b). Sleeper Cars
- i). Each HVAC unit shall have its own temperature controls, monitoring the car temperatures of the respective zone.
 - ii). Separate car air temperature sensors shall be used to provide independent floor heat control in open-body areas as well as hallways.
 - iii). Floor Heat is an enable function for individually controlled sleeper room heat.
 - iv). In the sleeper compartments, each passenger/crew room supply air diffuser shall be integrated into the room's touch screen pad to allow the room occupant to modulate the volume of conditioned air entering the room.
 - v). Likewise, floor heat modulation for each room shall be integrated into the room's touch control screen pad.
 - vi). The temperature differential between the upper and lower berth of each configuration of sleeper car room shall be less than 4°F ; (room air circulation fans may be used if required)
 - vii). An exhaust duct system and fan shall be used to collect air from each toilet/shower, public restroom and shower, exhausting it to the roof away from fresh air intake. Sleeper compartments shall utilize static exhaust ventilation.
 - viii). The sleeper cars shall employ a duct running down the center of the roof, with inlets from each sleeping room, all toilet/showers as well as the public restrooms and showers.
 - (1) The exhaust fan will be located in the HVAC plenum, with the outlet venting it outside of the car.

- ix). The Supply Air Diffusers made of stainless steel or satin finish shall be provided in the lower row of window sills to distribute conditioned air to the following car areas:
 - (1) Accessible bedrooms, bedrooms, roomettes, attendant rooms, passenger seating areas, hallway, lounge, hallways, dining room, galley
 - (2) Vents shall be designed to prevent debris from falling into the diffusers, screens may be used if necessary.
 - x). Controls in passenger/crew rooms shall be integrated into room’s touch screen pad to allow the room occupant to adjust air flow volume.
 - xi). In the sleepers, the two HVAC units both receive identical control instructions from the temperature controls but have independent internal controls.
 - (1) In this way, the A and B-end HVAC units may be controlled separately but supply of the conditioned air is provided to the entire car, at a reduced level if one unit fails.
 - (2) Details of the by-pass mode shall be developed during design review.
 - xii). The duct heat primarily is used to temper car fresh air, whereas floor heat is used to overcome carbody losses and adjust room temperature.
 - xiii). In general, floor heat and duct heat will be independently controlled.
 - xiv). All car ventilation and humidity control shall be provided by the HVAC unit.
- c). Noise and Vibration
- i). The overall HVAC system shall be designed to minimize noise in the passenger and crew areas of the trainset cars.
 - ii). The noise level from the HVAC system shall not exceed the values in the following table.

Figure 10-4: Maximum Noise Levels

Interior noise level: Coach seating areas, toilet rooms and galley	As specified in Chapter 11
Exterior noise level	75 Decibels (Acoustic) (dBA) max (15 ft from centerline of vehicle)

- iii). Particular care shall be required at the return air grilles, and galley ceiling air diffusers.

- iv). The main parts of the HVAC system should minimize the transmission of noise and vibration into the car interior.
- v). Vibration eliminators shall be incorporated in base of compressors or motors if necessary and in the refrigerant lines between resiliently mounted compressor(s) and rigidly mounted piping.
- vi). The evaporator blower and condenser fan assemblies shall be balanced according to IEEE Standard 11-2000 "IEEE Standard for Rotating Electric Machinery for Rail and Road Vehicles" with no more than 0.001-inch peak-to-peak displacements in any direction.

10.4 Air Conditioning

a). General

- i). Two identical self-contained, hermetically sealed, HVAC units shall be provided on each car in the trainset.
- ii). The HVAC units shall be identical, self-contained, independent, easily removable, interchangeable among like cars, have seamless integration with the car shell design, be contained within a stainless steel or aluminum housing and be mounted in a watertight recess on the main carbody or structure with an IP rating of IP66 or better.
- iii). If dissimilar metals are used, there shall be sufficient dielectric isolation from the carbody.
- iv). Each occupied area of each car of the trainset shall be supplied by two HVAC units arranged so that conditioned air will be evenly distributed to all areas including food service, crew, and baggage areas in the event of a failure of one of the HVAC units.
- v). The air conditioning system shall be designed and adequately sized to maintain interior trainset car temperature as specified at the normal ambient conditions.
- vi). For ambient temperatures at or above 110°F Dry Bulb/76°F Wet Bulb, with air entering the condenser above 120°F, the air conditioning system shall be capable of maintaining cooling at a reduced capacity, but in no case shall the average interior temperature be less than 30°F below the outside temperature up to 130°F ambient temperature.
- vii). Application and integration of the system are to be in accordance with the recommendation of the air conditioning manufacturer who shall also specify air flow requirements.

b). Refrigerant

- i). The units shall be designed for an approved refrigerant at the time of delivery of the first vehicles, conforming to 40 CFR 82 and EPA regulations for GWP refrigerants.

- ii). All production units must comply with any new regulations regarding refrigerant phase out enacted at time of manufacture, and any new refrigerant or component changes associated with new regulations must be backward compatible with earlier production units.
 - iii). All components within the unit, such as seals, shall be compatible with the refrigerant and its associated lubricants.
- c). Components
- i). The refrigeration system shall include, at a minimum, the following components and features or alternative design as approved by Amtrak:
 - (1) Drain Pans
 - (a) A replaceable condensate drain pan shall be provided beneath the evaporator coil, headers, thermal expansion valves and coil U bends to collect moisture from the evaporator components subject to sweating.
 - (b) The condensate drain pan shall be made of stainless steel, with stainless steel or copper alloy fittings and shall discharge into the drain pan.
 - (c) The HVAC unit shall be mounted above replaceable drip pans and shall be sealed against moisture entering the carbody.
 - (d) The drain pans shall catch the evaporator condensate as well as any water entering the compressor/condenser section.
 - (e) All collected moisture shall be directed to the roadbed through the car sidewall, without leaking into the car structure and shall not be discharged on undercar structure, wheels, brakes, trucks, or electrical equipment.
 - (f) Elastomeric silicone rubber flapper type check valves must be provided at the ends of the condensate drains.
 - (g) The exits of the drain pan lines to the undercar shall be arranged in an approved manner that shall be readily accessible for maintenance and shall be protected against clogging and rodent/wasp entry.
 - (h) Drain pan design and maintenance shall be presented for review and approval during design review.
 - (2) Compressors
 - (a) A service proven and efficient variable speed single scroll or two scroll type refrigerant compressors operating seamlessly between 30% and 100% capacity.

- (b) If tandem scrolls are employed, means shall be provided to alternate use of compressors during single stage cooling so as to equally distribute use and wear.
- (c) The Contractor may propose an alternative capacity regulation method for review by Amtrak.
- (d) Pump-Down
 - (i) Refrigerant compressor shutdown control shall be by means of a pump down cycle that senses suction line pressure. The system shall automatically reset without faults of the input power to the compressors was interrupted.
 - (ii) Refrigerant system controls must include a bump start process that prevents liquid build up in a loss of power condition when pump down was not initiated or at start up if pump down routine has not occurred in the previous 90 minutes.
 - (iii) Pump-down or similar system must not be initiated if the system shut down is initiated by a protective safety device such as excessive pressure, temperature, or current protective devices.
 - (iv) A refrigerant control box, readily accessible within the return air opening, shall be provided containing transducers, service switches, etc.
- (3) Condenser Fans
 - (a) Direct drive condenser fan and motor assemblies.
 - (b) Condenser fan motors must be rated IP56 per IEC 60529 or higher.
- (4) Condenser Coil Assemblies
 - (a) Condenser coil assemblies with 0.008 in. thick copper or an approved coated aluminum fins on copper tubing at a spacing of maximum 8 fins per in.
 - (b) Fins and tubes evaluated for minimum 600 hours in AASS per EN ISO 9227.
- (5) A charging port and an evacuation port equipped with high quality Schrader valves and sealing metal caps.
- (6) Filter Drier
- (7) Discharge line check valves

- (8) Sight glass/moisture indicators
- (9) Direct drive supply air blower and motor assemblies
- (10) Liquid line solenoid valves (2 per unit)
- (11) Thermal expansion valves (2 per unit)
- (12) Evaporator Coil Assemblies
 - (a) Evaporator coil assemblies with two interlaced cooling circuits for modulated and full cooling.
 - (b) The assembly shall have 0.008 in. thick copper or an approved coated aluminum fins on copper tubing at a spacing of maximum 10 fins per inch.
 - (c) Fins and tubes evaluated for minimum 480 hours in AASS per EN ISO 9227
- (13) High- and low-pressure switches.
- (14) High- and low-pressure transducers.
- (15) Vibration Eliminators
 - (a) Vibration eliminators shall be incorporated in base of compressors or motors if necessary and in the refrigerant lines between resiliently mounted compressor(s) and rigidly mounted piping.
- d). Leak and Charging Procedure
 - i). Leak and Charging procedure for Refrigeration System shall be submitted to Amtrak for review and approval. **[CDRL 10-03]**
- e). Leak Detection
 - i). Leakage detection shall be monitored on all coils to detect refrigerant leaks and communicated to the car diagnostic system.

10.5 Heating

- a). General
 - i). Each zone of the car shall be electrically heated using forced air overhead heaters in the HVAC unit and by convection heaters evenly distributed in the vehicle interior to provide maximum possible comfort for all passenger areas of the train.
 - ii). The heating system shall compensate for carbody losses and fresh air heating loads.

- iii). The floor level heating elements as fan motor, heating resistor and safety thermostats are considered an LLRU.
 - iv). The heating system shall be designed, controlled and be adequately sized to maintain interior temperatures as specified, throughout the trainset at normal outside ambient conditions.
 - v). Main heat shall be divided into stages to allow control of overhead heat output.
 - vi). The size of each heating stage shall be chosen and controlled so that cycling of the heating contactors is minimized.
 - vii). The maximum allowable heater grill and enclosure surface temperature accessible to passengers or train crew shall not exceed 125°F.
 - viii). The overhead heaters shall be protected against over-temperature.
 - (1) Over-temperature protection utilizing airflow detection, resettable and manual reset devices and other control means shall be evaluated during design review prior to approval by Amtrak.
 - ix). Antifreeze protection, activated at an outside temperature of 45°F, shall be provided for the water tank and water drain valves, doors and thresholds, and elsewhere as required.
 - x). The protective heater circuits shall be protected by an independent circuit breaker.
- b). Layover Mode
- i). Layover heat shall be provided by the floor heat and shall maintain an interior temperature of 50°F ± 5°F.
 - ii). During layover heating, the evaporator fans shall not operate and the fresh air damper shall be closed.
- c). Freeze Protection
- i). Freeze protection system shall be provided to the side doors, thresholds, water tanks, water drain valves, and all water and waste system components that may be exposed to freezing conditions.
 - ii). Freeze protection shall be provided and turned on when the ambient outside temperatures drop below 45°F, and shall shut off when the outside temperatures rise to 50°F.
 - iii). The freeze protection heaters shall have an LED indicators easily accessible by the maintainers.
 - iv). The system shall be controlled and monitored through the HVAC controller and shall allow unrestricted vehicle operation of systems down to -30°F

ambient temperature under all weather and train operating conditions, including at full operating speeds.

d). Overhead Heaters

- i). Overhead heaters shall be supplied within the evaporator compartment to provide tempering for fresh air intake and for reheat to maintain humidity control under partial cooling operation of the air-conditioning apparatus.
- ii). The total heat capacity in shall be divided into stages to allow control over heat output, and control scheme shall be submitted for review and approval. **[CDRL 10-04]**
- iii). The heater elements shall be of low thermal inertia, open coil, resistance wire type with terminations, and insulated supports as approved by Amtrak.
- iv). Alternative configurations shall be submitted to the Project Manager for review and approval.
- v). The heaters shall be powered from the nominal 480 VAC supply and shall be staged to provide variable power operation.

e). Overhead Heater Protection

- i). The overhead heaters shall be protected against over-temperature.
- ii). Over-temperature protection utilizing airflow detection, resettable and manual reset devices and other control means shall be evaluated during design review prior to approval by Amtrak.
- iii). An automatically resettable overheat protection thermostat (OHPT1) shall be installed in a location to sense the temperature reliably and accurately in the area of the heater coils.
- iv). The thermostat shall be wired directly in series with the coil of the overhead heat contactor and shall also provide feedback to the control logic.
- v). The set point shall be selected such that the overhead heaters may cycle indefinitely on overhead thermostat control with no damage caused to any HVAC system components.
- vi). The set point shall also prevent nuisance trips from any condition that may be expected to arise during normal operation, including operation over the allowed range of input voltage and air filter maximum recommended pressure drop.
- vii). A backup overheat protection thermostat (OHPT2) shall be provided to positively remove power to the overhead heater elements in the event of a control failure or failure of the overheat thermostat.
- viii). The backup protection may be a thermostatic sensor wired to a shunt-trip circuit in the overhead heat circuit breaker.

- ix). The set point shall be selected such that no damage shall occur to any HVAC component by temperatures reached before or after the back-up protection device actuates.
 - x). The setting of the back-up device shall be coordinated such that it will not actuate under any conditions which may be achieved with normally operating controls and functional overheat thermostat.
- f). Heated Floor Panels
- i). All passenger loading entrance areas shall be equipped with service proven heated floor panels that are easily removable and replaceable.
 - ii). The heated floor panels shall not be covered with any module or the replacement of any heated floor panel shall not require the disassembly of other assemblies unless otherwise approved by Amtrak.
 - iii). The total floor heat capacity in each zone shall have uniform temperature distribution throughout the whole vehicle for passenger comfort.
 - iv). Each floor panel must be protected with two levels of over-temperature protection as specified under UL 1995, Section 30, Electric Heaters.
 - v). Fault detection and diagnostic features of heated floor panels shall be submitted for review and approval. **[CDRL 10-05]**
 - vi). Alternate methods of heating and temperature regulation, ground fault detection and protection may be submitted for consideration by Amtrak.
- g). Floor Heaters
- i). It is preferred that floor heaters are not utilized; however, in the event that proper temperature stratification inside modules is not possible without floor heaters, the following applies:
 - (1) Floor heating shall be provided throughout the passenger areas using convection type heaters.
 - (2) The Contractor shall take appropriate steps in the design of the floor heat system to minimize overall power demand while complying with all technical requirements of this specification.
 - (3) Alternative capacity regulation method may be provided for approval by Amtrak.
 - (4) Floor heating shall be provided using electric strip heaters, powered from the 480 VAC HEP supply, mounted behind stainless steel heater guards along the side walls at the floor.
 - (5) The electric floor heater elements shall consist of a nickel-chromium resistance wire embedded in a baked, compressed, refractory material sealed within a rust proof, high heat transfer metal sheath.

- (6) The heater elements shall be mounted on ceramic standoffs, or equivalent, to provide a high resistance to arcing or grounding under wet conditions.
- (7) The floor heat shall have sufficient capacity to heat the car interior to 70° F under most restrictive ambient conditions with the ventilating fans and overhead heat inoperative and without benefit of solar or passenger loads.
- (8) The heaters shall be uniformly distributed.

h). Heater Fault Detection and Protection

- i). Each heated floor and floor heater circuit shall have its own circuit breaker, fault detection and protection.
- ii). The heater fault detection circuit shall be able to indicate if any of the heaters in the circuit is either open, shorted, or grounded.
- iii). Each heater circuit shall have current input to and output from the floor heaters monitored by the differential relay which energizes for a predetermined difference between the two.
- iv). When this relay energizes, both the positive and negative feeds to the affected floor heater circuit shall be interrupted.
- v). The ground fault type circuit shall remain latched in the disconnected mode until manually reset by means of a momentary reset button located in the HVAC control box.
- vi). The fault trip must not be affected by control power loss or fluctuation.
- vii). A tripped ground fault circuit shall be annunciated by means of an LED indicator on the ground fault detection device in the HVAC control box and transmit to the car diagnostic system.
- viii). The sensor device shall be designed such that it is not necessary to disconnect heater power leads to remove and replace the ground fault detection unit.
- ix). A separable sensing coil or other approved method shall be provided to accomplish this requirement.
- x). Alternate methods of ground fault detection and protection may be submitted for consideration by the Project Manager.

10.6 Ventilation

a). General

- i). The ventilation system for each car of the trainset shall include, at a minimum, the following components and features:

- (1) Exterior fresh air intakes with water eliminators.
 - (2) Fresh Air intakes must be in a location that will not allow diesel or exhaust fumes or by-pass and avoid the effect of road track dirt.
 - (3) Electrically motorized automatic fresh air dampers
 - (4) Disposable pleated-type fresh and return air filters with a minimum of MERV 13. Alternative designs for improved air quality and filtration up to and including HEPA filters is strongly encouraged.
 - (5) Air distribution ducts
 - (6) Air diffusers and grilles
 - (7) Exhaust ducts
 - (8) Exhaust fans
 - (9) Emergency fan shutoff switches
- ii). The ventilation system shall provide a minimum positive carbody pressurization of 0.1 in. water gage (with full fresh air flow) above ambient exterior pressure with all exterior doors and windows closed and the toilet room and electric locker exhaust fans running, and the trainset operating at normal speeds.
- b). Fresh Air Mixing
- i). Intake of filtered fresh air shall be regulated according to demand and design for requested Fresh Air.
 - ii). Fresh air shall enter the car through water eliminators and air filters which include drains for condensation and water to be diverted to the outside of the car.
 - iii). In addition, the fresh air exterior intakes shall be fitted with louvers or grilles that prevent ingress of water and snow.
 - iv). Re-circulated air shall pass through grilles into a plenum chamber where it shall mix with the fresh air and pass to the HVAC unit blower.
 - v). Fresh and re-circulated air shall each be filtered at the HVAC units by disposable pleated-type filters.
 - vi). The filters shall be a minimum of MERV-13 and be located for ease of replacement from inside the vehicle via the return air grill and shall meet the requirements specified in Amtrak Specification 685 and be commercially available.

- c). Return Air Temperature Sensors
 - i). The Return Air Temperature Sensors should be installed in such way that they only measure the temperature of the re-circulated air, and not when later mixed with the fresh air.
- d). Evaporator Blower Fans
 - i). Ventilation of each car in the trainset shall be provided by blower fans supplied as part of the HVAC units.
 - ii). The blower fans shall move the mixed air through the cooling and heating coils and force the conditioned air into the supply air ducts.
 - iii). The evaporator blower fans shall be sized to overcome the high external static pressure as determined by the Contractor.
 - iv). The blower shall be centrifugal type, directly driven from the motor shaft.
 - v). The motor shall be TEFC, class H insulation, resiliently mounted, and equipped with permanently lubricated sealed bearings.
 - vi). Use of variable speed motor controls for the blower and exhaust fans is permitted if it will lead to a more efficient and energy saving system.
- e). Air Ducts
 - i). The air ducts shall be sized to minimize noise from air velocity.
 - ii). The air ducting shall be free of any obstructions such as electrical wiring or piping.
 - iii). Ducts should be able to be cleaned using rotating brushes with vacuum system.
 - iv). Mounting of the air ducts to the carbody structure shall minimize noise and heat transfer across the joints.
- f). Insulation
 - i). Use of polyolefin insulation is prohibited including the use of any type of insulation inside the air ducts.
 - ii). Insulation shall be adequate to prevent condensation from occurring in or outside the duct under any operating conditions.
 - iii). Insulation shall comply with Amtrak Flame, Smoke and Toxicity Requirements, # 352.
- g). Air Discharge
 - i). The air diffusers shall be designed to deliver equalized airflow throughout the car and meet the temperature variation requirements specified.

- ii). The velocity of discharge air shall not exceed 100 feet per minute (fpm) measured 6 in. below the face of the diffusers.
 - iii). Air delivery performance shall be verified during HVAC system proof-of-design testing. Refer to Chapter 20.
 - iv). The diffusers shall be fixed on all vehicles, except for the trainset car(s) designated for proof-of-design testing, where adjustable diffusers may be used and then permanently set following successful test.
 - v). The total air flow from the evaporator blower fans on the HVAC units shall be determined by the Contractor to meet the interior requirements at the specified ambient temperatures but shall not be less than 70 cfm per foot of occupied train length.
 - vi). The supply air shall be adequate to maintain positive interior pressurization under all operating conditions and a minimum of 0.1" w.g. while at standstill.
- h). Baffle Plates
- i). Baffle plates shall be used to set the volumes of fresh and re-circulated air.
 - ii). The baffle plates shall be fixed on all cars, except for the trainset car(s) designated for testing, where adjustable baffle plates may be used and then permanently set following successful test.
 - iii). Adjustment and balancing procedures shall be included in the final deliverables with the trainset and identified in the maintenance manuals.
- i). Toilet Room Exhaust Fans
- i). A forced exhaust fan vented to the exterior of the car shell shall be provided in each toilet room, exhausting away from any fresh air intake for minimum 0.5 cfm/ft² to maximum 1 cfm/ft².
 - ii). Toilet room exhaust shall, at all operating speeds, maintain a negative pressure in the toilet room at all times when activated, as compared to the rest of the car interior.
 - iii). The fan shall be automatically activated when toilet room door is locked and shall continue to operate for five minutes after the door is unlocked. Provisions shall be offered to activate the fan if door has not been locked in one hour, the fan will be activated and operate for five minutes. Both parameters shall be software adjustable by Amtrak as necessary, up to and including the situation where the fan remains always on.
 - iv). The inlet shall be placed to provide maximum effectiveness in reducing odors.
 - v). Another method of preventing toilet odors in the car utilizing air fresheners shall be proposed and approved by Amtrak.

- j). Electric Locker Ventilation
 - i). A forced exhaust flow shall be provided in the electric locker to assist in cooling the electrical equipment in the electrical locker.
 - ii). The electric locker fans shall draw air from the car interior and exhaust it to the exterior.
- k). Controls
 - i). The temperature controls shall provide for ventilation with no heating or cooling when temperature conditions fall in the ventilation range shown for the comfort requirements in Section 10.3.
 - ii). Ventilation detection and interlocking devices shall be provided and installed such that there shall be no overhead heat and/or cooling when absence of ventilation is detected.

10.7 Fresh Air Dampers

- a). The fresh air intakes shall be equipped with electrically power operated fresh air dampers that shall at a minimum provide three positions:
 - i). fully open
 - ii). fully closed
 - iii). adjustable stop for restricting
- b). The dampers shall be controlled by the vehicle temperature control panel; the dampers shall be used to provide full fresh air into the vehicle under normal operating conditions.
- c). The microcontroller shall send the damper positions and status to the vehicle monitoring system.
- d). With temperatures outside the normal range, the dampers shall operate variably between open and closed to optimize fresh air quantity for the purpose of maintaining the required interior temperature while providing the maximum possible percentage of full fresh air.
- e). During layover and warm up/cool down, the dampers shall be fully closed.
- f). Alternate arrangements may be proposed to Amtrak for approval.
- g). The damper frame, blades and hardware shall be constructed of corrosion resistant material so they will last the life of the trainset with no attention other than inspection and cleaning at 8-year intervals.
- h). The drive motor shall be robust and readily available.
- i). The dampers shall incorporate a spring close feature so that they self-close upon loss of power.

CONFIDENTIAL — DO NOT DISTRIBUTE

- j). They shall also incorporate a position sensor to provide a feedback signal to the temperature control panel.
- k). Design of the damper unit shall keep the number of adjustments required to a minimum.
- l). Once settings are made, they shall be locked so they remain fixed for the life of the damper.

10.8 Controls

a). General

- i). A microprocessor-based, integrated HVAC temperature control system shall be provided to adjust the system's cooling, and heating functions as needed to meet the performance requirements in these Technical Specifications.
- ii). The system shall use solid state sensors for temperature and pressure data to monitor the inside and outside temperature and humidity levels.
- iii). Activation of the HVAC system on each car shall be under the control of the train crew.
- iv). The system shall be designed to maintain the specified interior passenger area temperature and humidity and to also ensure adequate interior ventilation.
- v). The output of the microprocessor shall be short circuit protected and shall drive solid state and electromechanical relays and contactors which shall, in turn, control electrical power to the heater elements, motors and various control devices.
- vi). The changeover between heating and cooling shall be automatic and, except for the reheat stage of overhead heat, shall preclude the simultaneous operation of heating and air conditioning.
- vii). Access Levels will be subject to review and approval by Amtrak:
- viii). The microprocessor application software shall permit Engineering Level maintenance personnel using on board touch screen display to modify temperature and pressure set points as well as various other parameters, such as timers.
- ix). For maintenance access levels and changes, the software must have two levels of protection to modify the settings:
 - (1) Level 1: "Tech" – Full diagnostic, overview of all inputs/outputs, download of logs, parameters are read only (or to change a small set - TBD) and reset to defaults.
 - (a) This access level is for viewing information and minor changes.

- (2) Level 2: "Supervisor" - Full diagnostic, overview of all inputs/outputs, download of logs, possible to change parameters for testing or other purposes and reset to defaults.
 - (a) This access level is for changing settings and parameters, except for critical or safety settings which can be requested and authorized by the manufacturer.
 - x). Measures shall be taken to prevent control algorithms that might cause contactor hunting.
 - xi). Provisions shall be made to control, download, and monitor HVAC status information from a single point of access through inter-car connections.
 - xii). All HVAC sensor inputs, faults, and monitoring shall be available to the car's vehicle diagnostic system and shall be available remotely.
 - xiii). Heating and cooling shall be sufficiently capable of maintaining desired interior temperature near the lockout temperatures for the compressors or condenser fans with maximum solar loads.
 - xiv). The HVAC Control Enclosure must contain a local PTE port equipped with Ethernet communication interface.
 - xv). Ethernet communications is in accordance with Train Real Time Data Protocol (TRDP) as defined in IEC 61375-2-3 and must be able to be close and latch any door with the local test interface connected.
- b). Sensors
- i). A sufficient number of temperature and humidity sensors shall be provided to regulate heating and cooling in response to temperature changes inside and outside the vehicle.
 - ii). Temperature sensors in the car body shall be located such that they reflect temperature without being influenced by external heat sources or solar radiation.
 - iii). All sensor information shall be recorded by the controller and available to the vehicle monitoring system.
 - iv). At a minimum, the following temperature thermistor sensors shall be required:
 - (1) Minimum of one interior temperature sensor located throughout the passenger seating area for layover heat.
 - (2) Return air sensor at each HVAC unit return air grille.
 - (3) Fresh air sensor at each HVAC unit fresh air inlet.
 - (4) Supply air sensor where each HVAC unit supplies the main duct.

- (5) Freeze protection thermostat located in a position that accurately measures outside temperature. (May utilize a signal from the fresh air sensor).
 - (6) Evaporator coil sensors to detect ice buildup on the evaporator coils.
 - (7) Humidity sensor at each HVAC Unit (location TBD)
- c). Use of Controls
- i). The temperature control system for each car shall be under the command of a rotary mode selector switch located in the switch locker and operated by the train crew.
 - ii). Status display shall determine the operating mode of each of the two HVAC systems and the heating system.
 - iii). The mode selector shall switch from AUTO/NORMAL to LAYOVER without cycling the HVAC through OFF.
 - iv). In the event an air conditioning compressor is in operation when it is commanded to shut down, the pump down cycle shall be initiated before the compressor(s) are shut down.
 - v). Positions and functions are as follows:

Figure 10-5: Temperature Control Positions

Name	Function
AUTO/NORMAL	Car HVAC and heating set up and provides the normal occupied car environment. All systems including freeze protection operate automatically.
LAYOVER	Used for car storage in winter to minimize energy consumption, yet still maintain interior temperature of 50°F. Only floor heat and freeze protection shall be available.
TEST MODE	Used to test the HVAC system and their performance per settings. Used also to verify the functions of the devices. Changes are not permanent, and the safety settings are not disable.
OFF	Used to shut off all car heating and cooling when trainset is being serviced or in storage. Does not disable the freeze protection system.

- vi). Functionality of the selector switch shall also be fully incorporated into the HMI for each car.

d). Status Display

- i). Each HVAC control panel shall include an indicator and monitor display which shall show the control logic state, unless other display options are reviewed and approved by Amtrak.
- ii). Indications shall be by means of suitably labeled Light Emitting Diodes (LEDs) and by an LCD screen, which shall display all microprocessor requests for heating or cooling from the zones controlled from that panel.
- iii). Fresh air temperature, supply air temperature, return air temperature, suction line pressure and discharge pressure shall be displayed for each HVAC unit.
- iv). Overload indicators and resets shall be available for use by the train crew without exposing the crew to hazardous voltages.
- v). The control system shall include the ability to download data using a laptop computer or a flash memory card that is loaded with the Contractor's HVAC diagnostic software.
- vi). The HVAC controllers shall report alerts and faults to the car diagnostic system.
- vii). The HVAC diagnostic software shall provide the following functionality:
 - (1) A controller that provides HVAC system status at a glance and has strong diagnostic features.
 - (a) This includes remote viewing of all sensor status, alerts, errors and relevant data reporting to the CDU.
 - (2) A Maintenance mode where a technician can force various functions of the HVAC including temperature set points.
 - (3) Monitor the HVAC system and provide the following:
 - (a) Display HVAC system pressure and temperatures
 - (b) Display HVAC System current mode
 - (c) Display suction and discharge line temperatures
 - (d) Display ambient air, fresh air, supply and return air temperatures
 - (e) Display motor status and current of blower motor and condenser motor
 - (f) Display heater status and current
 - (g) Display humidity level
 - (h) Display fresh air damper position and status

CONFIDENTIAL — DO NOT DISTRIBUTE

- (i) Forecast air filter replacement and condenser and evaporator coil cleaning through the use of differential pressure sensors
 - (j) Ability to record and indicate system faults
 - (k) Automatically calculate system superheat and subcooling
 - (l) HVAC High Pressure and Low Pressure fault Condition
- (4) Have the capability to test the HVAC system and temporarily override the control system.
- (5) Log performance, all faults and download history.
- (6) Have several levels of security to limit the access and controls of the system (crew, technician, programmer).
- (7) Provide capability to diagnose failures down to the failed component. Details to be discussed during design review.
- viii). The control system shall include, at a minimum, the following components and features:
- (1) Temperature sensors
 - (2) Motor starters
 - (3) Motor protective devices
 - (4) The control method shall rely on a combination of the return air and fresh air temperature measurements.
 - (5) The following control device functions shall be reviewed and approved by Amtrak and their functions will be monitored by the controller and their activation displayed, including any lockout criteria that is met.
 - (6) Diagnostics and test capabilities
 - (7) Integration into the CDU.
- ix). The Contractor shall submit a temperature control schedule and a detailed description of operation for approval by Amtrak at the HVAC system design review. **[CDRL 10-06]**
- (1) The temperature control schedule shall be approved by Amtrak.
 - (2) In the temperature control schedule, control switch points shall be separated by at least one degree differential for rising and falling temperatures to prevent oscillation of operating modes.
 - (3) A Ventilation Mode should be present between the heating and cooling modes.

- e). Emergency Ventilation Cut-Out Temperature Measurements.
 - i). The following control device functions shall be reviewed and approved by Amtrak and their functions will be monitored by the controller and their activation displayed, including any lockout criteria that is met:
 - (1) High Pressure switch
 - (2) Low Pressure switch
 - (3) Freeze Protection temperature sensor
 - (4) HVAC Emergency / Load Shed Operation
 - (5) Overheat protection devices
- f). Emergency Ventilation Cut-Out
 - i). Ventilation system isolation cut-out switches shall be provided on each level of the car for use by the train crew.
 - ii). The emergency ventilation cut-out shall immediately shut down the HVAC system ventilation blowers on all HVAC units to prevent the circulation of smoke or fumes throughout the car in the event of an emergency.
 - (1) This function shall be applied with the trigger from a smoke or fire detection in any room, locker, or compartment.
 - iii). Operation of the ventilation cut-out shall also fully close the fresh air dampers and any exhaust air fans, if provided.
 - iv). The switch arrangement and labeling shall be identical as that used on existing Amtrak cars and shall be approved by Amtrak during design review.
- g). HVAC Emergency / Load Shed Operation
 - i). In the event of a load shed operation or loss of HEP power supply, HVAC ventilation shall continue to run off of trainline battery power, or another approved alternative method to provide emergency ventilation for up to 8-hours.
 - ii). Ventilation rate may be reduced if necessary, but shall be subject to Amtrak review and approval and in no case shall be below 8 CFM per passenger for AW2 loading.

10.9 Accessibility and Maintainability

- a). Each HVAC unit shall be designed to provide full accessibility where all the basic troubleshooting and running maintenance can be performed from inside the car without removing the equipment and without interference from other systems.
- b). All filter replacement shall be performed from inside of the car.

- c). Where necessary, the Contractor shall provide custom lifting eyes, slings, jigs or handles that allow safe removal and replacement of major components using Amtrak's existing maintenance facility and material handling equipment.
- d). Tapered guide pins or a suitable method shall be provided to guide each HVAC unit into its position.
- e). Quick connections shall be provided to the car air ducts and electrical connections.
- f). The installation and removal process, including removing and installing all mounting hardware, and electrical connections, shall not exceed one hour and shall be demonstrated for Amtrak approval before final approval of the final design review.
- g). At a minimum, the following components shall be a part of the unit and shall be easily accessible for servicing or replacement either through a hinged grille, which provides access to the return air plenum from the inside of the vehicle, or through an interior access door located in the intermediate level ceiling or alternate location:
 - i). Air filters,
 - ii). Diagnostic test plug/connector for the PTE
 - iii). System fault and status LED's
 - iv). Return air sensors
 - v). Dampers
 - vi). Test switch, if provided
 - vii). All electric transducers and pressure controls
 - viii). Circuit breakers, relays, and contactors
 - ix). Refrigerant gauge ports
 - x). Liquid line sight glass
- h). It is anticipated that the air sensors shall be accessible via the return air plenum and the other components shall be accessible through interior access doors in the intermediate level ceiling or alternate location.
- i). All other components shall be easily accessible for servicing and replacement from within the equipment bay.

10.10 CDRLs

CDRL	Description	Due
CDRL 10-01	Detailed heating and cooling load analysis	30 days prior to PDR, on-going updates for each DR
CDRL 10-02	In-rush mitigation control scheme	30 days before IDR
CDRL 10-03	Leak and Charging procedure for Refrigeration System	30 days before IDR
CDRL 10-04	Overhead heater control system	30 days before IDR
CDRL 10-05	Fault detection and diagnostic features of heated floor panels	30 days before IDR
CDRL 10-06	Temperature Control Schedule	30 days before IDR

* End of Chapter 10 *

Amtrak Long Distance Bi-Level Fleet Replacement

Technical Specification

11. Interiors

Revision 1

Table of Contents

Part I: General Requirements	11-1
11.1 Overview	11-1
11.2 General Requirements	11-1
11.3 Human Factors Study.....	11-2
11.4 Accessibility and Universal Design	11-3
11.5 Arrangement Flexibility and Modularity	11-4
11.6 Signage and Labels.....	11-4
11.7 Interior Noise Levels (Passenger Areas)	11-5
11.8 Vibration.....	11-6
11.9 Sanitary Design	11-7
11.10 Maintenance and Material Performance Expectations	11-8
11.11 Safety.....	11-9
Part II: Interior Components	11-11
11.12 Doors and Latches	11-11
11.13 Windows.....	11-11
11.14 Window Masks	11-11
11.15 Window Blinds.....	11-12
Part III: Storage Areas	11-13
11.16 Storage in Coach Areas	11-13
11.17 Trash and Recycling Storage	11-13
11.18 Linen Closets.....	11-16
11.19 Consumable Supply Closet	11-17
11.20 Cleaning Supply Cabinet	11-18
11.21 Emergency Equipment	11-19
11.22 Luggage Storage - General	11-19
11.23 Overhead Luggage Storage	11-22
11.24 Luggage Towers.....	11-24
Part IV: Integrated Electronics and Technology	11-26
11.25 Digital Displays.....	11-26
11.26 Keyless or Card Access	11-31
11.27 Electrical Locker and Panels	11-32
11.28 Outlets.....	11-33
11.29 Seat Reservation.....	11-35

11.30	Video Surveillance.....	11-36
Part V: Interior Structures		11-37
11.31	Stairways.....	11-37
11.32	Elevators - Interiors	11-38
11.33	Bulkhead Walls.....	11-42
11.34	Ceilings	11-44
11.35	Flooring	11-45
11.36	Hallways.....	11-49
11.37	Entrance Areas.....	11-56
Part VI: Coach Areas.....		11-65
11.38	Interior Structures - Coach Specific	11-65
11.39	Seats - General	11-71
11.40	Standard Coach Seats	11-71
11.41	Premium Coach Seats.....	11-81
11.42	Accessible Seating Spaces for Wheeled Mobility Users	11-90
11.43	Tables	11-91
Part VII: Restrooms.....		11-93
11.44	Restrooms - General	11-93
11.45	Standard Toilet Room (STR)	11-95
11.46	Accessible Toilet Room (ATR).....	11-104
Part VIII: Sleeper Cabins.....		11-117
11.47	Sleeper Cabin General Requirements	11-117
11.48	Roomette.....	11-127
11.49	SoloSuite.....	11-133
11.50	Club Bedroom	11-140
11.51	Premium Bedroom.....	11-148
11.52	Accessible Twin.....	11-158
11.53	Accessible Double	11-171
11.54	Accessible Premium Bedroom.....	11-182
11.55	Sleeper Cabin Restrooms.....	11-193
11.56	Sleeper Cabin Showers.....	11-194
11.57	Sleeper Cabin CMF	11-199
Part IX: Sleeper Cabin Key Features		11-201
11.58	Sleeper Cabin Key Features - General.....	11-201

11.59	Sleeper Cabin Key Features - Communications	11-210
11.60	Sleeper Cabin Key Features - Seating Area / Lower Sleeping Berth / Bed	11-211
11.61	Sleeper Cabin Key Features - Upper Sleeping Berth.....	11-220
11.62	Sleeper Cabin Key Features - Personal Care	11-222
11.63	Sleeper Cabin Key Features - Trash	11-237
11.64	Sleeper Cabin Key Features - Storage	11-238
11.65	Sleeper Cabin Integrated Systems	11-246
11.66	Additional Storage in Sleeper Cars.....	11-248
Part X: Common Use Areas.....		11-250
11.67	Beverage Stations	11-250
11.68	Lounge	11-254
11.69	Diner	11-264
11.70	Café	11-274
11.71	Lactation Room (Option)	11-281
11.72	Drinking Water Stations.....	11-284
Part XI: Utility Cars.....		11-286
11.73	Utility Car - Baggage Area	11-286
11.74	Utility Car - Luggage Racks	11-287
11.75	Utility Car - Gun Locker	11-289
11.76	Utility Car - Storage Areas	11-291
Part XII: Crew Areas.....		11-293
11.77	Crew Sleeper Cabin	11-293
11.78	Conductor Office	11-298
11.79	Kitchenette	11-298
11.80	Crew Restroom	11-302
11.81	Crew Shower.....	11-303
Part XIII: CDRLs		11-304
11.82	CDRLs.....	11-304
Part XIV: Figures.....		11-305

Table of Figures

Figure 11-1: Trash and Recycling Quantities	11-16
Figure 11-2: Required Luggage Storage Locations.....	11-20

Figure 11-3: Luggage Storage Key Features 11-21

Figure 11-4: Required Display Screens..... 11-29

Figure 11-5: Required Keycards and Locations..... 11-31

Figure 11-6: Floor Covering Table..... 11-47

Figure 11-7: Key Features - Hallways 11-53

Figure 11-8: Key Features - Entrance Areas 11-61

Figure 11-9: Key Features - Coach Interior Structures 11-66

Figure 11-10: Key Features - Standard Coach Seats 11-74

Figure 11-11: Key Features - Premium Coach Seat..... 11-84

Figure 11-12: Key Features - Standard Toilet Room..... 11-97

Figure 11-13: Key Features - Accessible Toilet Room..... 11-106

Figure 11-14: Key Features - Sleeper Cabins: General..... 11-119

Figure 11-15: Key Features - Sleeper Cabins: Communications 11-120

Figure 11-16: Key Features - Sleeper Cabins: Seating Area / Lower Sleeping Berth / Bed 11-121

Figure 11-17: Key Features - Sleeper Cabins: Upper Berth 11-122

Figure 11-18: Key Features - Sleeper Cabins: Personal Care..... 11-123

Figure 11-19: Key Features - Sleeper Cabins: Trash 11-125

Figure 11-20: Key Features - Sleeper Cabins: Storage..... 11-126

Figure 11-21: Key Features - Roomette 11-128

Figure 11-22: Key Features - SoloSuite 11-134

Figure 11-23: Key Features - Club Bedroom..... 11-141

Figure 11-24: Key Features - Premium Bedroom..... 11-149

Figure 11-25: Key Features - Accessible Twin 11-159

Figure 11-26: Key Features - Accessible Double 11-172

Figure 11-27: Key Features - Accessible Premium Bedroom 11-184

Figure 11-28: Key Features - Sleeper Cabin Shower 11-195

Figure 11-29: Minimum Outlets by Cabin Type 11-208

Figure 11-30: Standard Sleeper Cabin Seat Widths..... 11-212

Figure 11-31: Single Leaf Fold Out Table Dimensions 11-219

Figure 11-32: Fold Out Sink Basin Minimum Internal Dimensions 11-224

Figure 11-33: Solid Surface Sink Basin Minimum Internal Dimensions 11-224

Figure 11-34: Sink Vanity Cabinet Locations..... 11-225

Figure 11-35: Compact Vanity Towel Capacity..... 11-226

Figure 11-36: Compact Vanity Towel Shelf Minimum Dimensions..... 11-226

Figure 11-37: Over-Sink Mirror Minimum Dimensions..... 11-227

CONFIDENTIAL — DO NOT DISTRIBUTE

Figure 11-38: Towel Storage Capacity by Cabin Type 11-231

Figure 11-39: Cabinet Minimum Dimensions..... 11-239

Figure 11-40: Beverage Station Appliances 11-251

Figure 11-41: Key Features - Lounge..... 11-256

Figure 11-42: Key Features - Diner..... 11-265

Figure 11-43: Key Features - Café..... 11-276

Figure 11-44: Key Features - Crew Sleeper Cabin..... 11-294

Figure 11-45: Luggage Tower 1 11-305

Figure 11-46: Luggage Tower 2..... 11-305

Figure 11-47: Alcove Luggage Tower 11-306

Figure 11-48: Stairway and Elevator Concept 11-307

Figure 11-49: Bulkhead Walls with Doors..... 11-308

Figure 11-50: Bulkhead Walls without Doors..... 11-309

Figure 11-51: Hallways 11-310

Figure 11-52: Hallway Light Locations 11-311

Figure 11-53: Entrance Areas 11-312

Figure 11-54: Entrance Area Light Locations 11-313

Figure 11-55: Coach Interior Structure 11-314

Figure 11-56: Coach Light Locations..... 11-315

Figure 11-57: Standard Coach Seat Dimensions 11-316

Figure 11-58: Standard Coach Seat Recline 11-317

Figure 11-59: Premium Coach Seat Dimensions..... 11-318

Figure 11-60: STR - Standard Toilet Room 11-319

Figure 11-61: STR Outlet Locations..... 11-320

Figure 11-62: STR Light Locations..... 11-321

Figure 11-63: ATR - Accessible Toilet Room 11-322

Figure 11-64: ATR Outlet Locations..... 11-323

Figure 11-65: ATR Light Locations..... 11-324

Figure 11-66: Roomette Cabin 11-325

Figure 11-67: Roomette Seat Dimensions..... 11-326

Figure 11-68: Roomette Outlet Locations..... 11-327

Figure 11-69: Roomette Wash Light Locations..... 11-328

Figure 11-70: Roomette Spot Light Locations 11-329

Figure 11-71: Roomette Compartment Light Locations 11-330

Figure 11-72: Roomette Reading Light Locations 11-331

CONFIDENTIAL — DO NOT DISTRIBUTE

Figure 11-73: SoloSuite Cabin	11-332
Figure 11-74: SoloSuite Seat Dimensions.....	11-333
Figure 11-75: SoloSuite Outlet Locations.....	11-334
Figure 11-76: SoloSuite Wash Light Locations.....	11-335
Figure 11-77: SoloSuite Spot Light Locations	11-336
Figure 11-78: SoloSuite Compartment Light Locations	11-337
Figure 11-79: SoloSuite Reading Light Locations.....	11-338
Figure 11-80: Club Bedroom Cabin.....	11-339
Figure 11-81: Club Bedroom Seat Dimensions	11-340
Figure 11-82: Club Bedroom Outlet Locations.....	11-341
Figure 11-83: Club Bedroom Wash Light Locations	11-342
Figure 11-84: Club Bedroom Spot Light Locations	11-343
Figure 11-85: Club Bedroom Lobby Light Locations.....	11-344
Figure 11-86: Club Bedroom Light Locations	11-345
Figure 11-87: Club Bedroom Reading Light Locations	11-346
Figure 11-88: Club Bedroom Restroom Light Locations	11-347
Figure 11-89: Premium Bedroom Cabin.....	11-348
Figure 11-90: Premium Bedroom Seat Dimensions	11-349
Figure 11-91: Premium Bedroom Outlet Locations.....	11-350
Figure 11-92: Premium Bedroom Wash Light Locations	11-351
Figure 11-93: Premium Bedroom Light Locations	11-352
Figure 11-94: Premium Bedroom Reading Light Locations	11-353
Figure 11-95: Premium Bedroom Ceiling Pool Light Locations.....	11-354
Figure 11-96: Premium Bedroom Restroom Light Locations	11-355
Figure 11-97: Premium Bedroom Shower Light Locations	11-356
Figure 11-98: Accessible Twin Cabin.....	11-357
Figure 11-99: Accessible Twin Seat Dimensions.....	11-358
Figure 11-100: Accessible Twin Outlet Locations.....	11-359
Figure 11-101: Accessible Twin Wash Light Locations.....	11-360
Figure 11-102: Accessible Twin Spot Light Locations	11-361
Figure 11-103: Accessible Twin Compartment Light Locations	11-362
Figure 11-104: Accessible Twin Reading Light Locations	11-363
Figure 11-105: Accessible Twin Ceiling Pool Light Locations.....	11-364
Figure 11-106: Accessible Twin Ladder Light Locations.....	11-365
Figure 11-107: Accessible Sleeper Cabin Restroom Lighting.....	11-366

CONFIDENTIAL — DO NOT DISTRIBUTE

Figure 11-108: Accessible Double Cabin 11-367

Figure 11-109: Accessible Double Seat Dimensions..... 11-368

Figure 11-110: Accessible Double Outlet Locations 11-369

Figure 11-111: Accessible Double Wash Light Locations 11-370

Figure 11-112: Accessible Double Spot Light Locations..... 11-371

Figure 11-113: Accessible Double Compartment Light Locations 11-372

Figure 11-114: Accessible Double Reading Light Locations..... 11-373

Figure 11-115: Accessible Double Ceiling Pool Light Locations 11-374

Figure 11-116: Accessible Sleeper Cabin Restroom Lighting..... 11-375

Figure 11-117: Sleeper Cabin Shower Modular Design..... 11-376

Figure 11-118: Shower for Sleeper Cabin Passengers..... 11-377

Figure 11-119: Shower Light Locations..... 11-378

Figure 11-120: Shower Electrical Outlet Locations..... 11-379

Figure 11-121: Beverage Station 11-379

Figure 11-122: Suggested Layout - Lounge 11-380

Figure 11-123: Suggested Layout - Diner..... 11-381

Figure 11-124: Suggested Layout - Café..... 11-382

Figure 11-125: Crew Sleeper Cabin..... 11-383

Figure 11-126: Crew Sleeper Cabin Seat Dimensions 11-384

Figure 11-127: Crew Sleeper Outlet Locations..... 11-385

Figure 11-128: Crew Sleeper Wash Light Locations 11-386

Figure 11-129: Crew Sleeper Spot Light Locations 11-387

Figure 11-130: Crew Sleeper Ceiling Pool Light Locations..... 11-387

Figure 11-131: Crew Sleeper Compartment Light Locations 11-388

Figure 11-132: Crew Sleeper Reading Light Locations 11-389

Figure 11-133: Crew Area Kitchenette 11-390

Part I: General Requirements

11.1 Overview

- a). This Chapter defines the interior design and configuration for each area within the trainset.
- b). All car types are bi-level with:
 - i). entry from station platforms through twin bi-parting doors on the lower level
 - ii). access between cars on the upper level, through single leaf sliding end doors.
- c). Accessibility
 - i). The accessibility areas of the car will be on both the lower and the upper levels.
 - ii). Car to car access is accomplished on the upper level.
 - iii). Access is accomplished with the elevator on the lower level.
 - iv). Additional lower level accessible positions shall be made available.
- d). Compliance with preliminary design concepts included in the specification and attachments does not relieve the Contractor of all the other requirements within the specification.

11.2 General Requirements

- a). This Chapter describes the basic interior configuration of all car types in this specification.
- b). Each car type shall include all requirements for ADA accessibility and general seating arrangements that provide comfort and amenities such as electrical outlets, task lighting, and individual work trays or tables.
- c). The interior of the car shall be designed and constructed for maximum safety, comfort, convenience, service to the passenger, and shall be fully ADA compliant along the accessible path.
- d). The Contractor shall factor in safety, crashworthiness, materials and workmanship, FDA cleaning clearances, radii, and sanitary design.
- e). All mechanisms described below should be durable, free from jamming, and racking.
- f). The design should meet abuse, load, and crash criteria as described in CFR.
- g). Dimensions, position, configuration, comfort, and usability of all items and features will be subject to Amtrak approval during the mockup review.

- h). Walls, ceiling panels, and window masks shall be easily cleanable and designed and constructed to form a safe and attractive environment.
- i). Visible fasteners shall be minimized.
- j). All systems requiring maintenance shall be easily accessible and removable for cleaning and repair.
- k). These conceptual interior layouts presented in Chapter 1 shall serve as a general guideline for the development of the interior of the cars.
 - i). Final interior layouts shall be developed by the Contractor and submitted to Amtrak for review and approval during design review per the Design Review processes outlined in Chapter 3.
 - l). Whenever possible, common components shall be used in all car types.
 - m). Strength of all interior fittings and their attachment to the carbody shall meet APTA Standard SS-C&S-006-98 and 49 CFR Section 238.233.
 - n). All interior or occupied areas shall have Emergency Lighting and LLEPM that leads to the primary exits.
 - i). These areas include non-seated areas restricted to crew members including the kitchen and baggage areas. See Chapter 13 for additional information.

11.3 Human Factors Study

- a). As part of PDR, the Contractor shall submit for Amtrak review and acceptance a Human Factors Study Report **[CDRL 11-01]**.
- b). The Human Factors Study shall address all key interaction points in the bedrooms, including but not limited to:
 - i). seat, bed, and bunk access
 - ii). tables,
 - iii). screens,
 - iv). switches,
 - v). cupboard access,
 - vi). door locks and handles.
- c). The report shall also address specific human factors for accessible rooms and restrooms, including but not limited to:
 - i). to accessible paths,
 - ii). aisle and door clearances accessible reach zones,

- iii). wheeled mobility device accessible features,
 - iv). wheeled mobility device and leg clearances,
 - v). handrail heights and sizes,
 - vi). transfer positions to seats, beds, toilets, and shower seats.
- d). Wheeled mobility device animations shall be included to validate accessible paths.

11.4 Accessibility and Universal Design

- a). Each car shall be fully compliant at the time of manufacture, with all rules and regulations of 49 CFR 38, Americans with Disabilities Act (ADA) Accessibility Specification for Transportation Vehicles and 2010 ADA Standard as applicable.
 - i). No part of these specifications alters or changes those requirements.
- b). Review of the car's accessible features (including all drawings, calculations, and supplier information required to define the proposed installation) shall be conducted with Amtrak as part of the mockup review.
- c). Each car with accessible positions shall include accessible wheeled mobility device locations, which shall allow passengers using wheeled mobility devices to remain in their wheeled mobility devices while on board the car.
 - i). The number of dedicated accessible areas for wheeled mobility devices is determined by the car configuration, as described in Chapter 1.
 - ii). A storage area for an unoccupied, folded wheeled mobility device, 48 in. long by 20 in. wide and 40 in. high, in close proximity to the dedicated accessible area and to accessible seating, shall be provided on each car.
- d). Each accessible coach which includes revenue seating shall also include an accessible toilet room.
 - i). The toilet room door shall operate automatically and may operate manually in emergency situations and shall be of the sliding type.
 - ii). Requirements for the toilet and associated equipment are detailed in this Chapter.
- e). ADA-compliant car-to-car access is required along the accessible path.
 - i). Each car shall include end doors and bulkhead doors that have a clear, unobstructed opening of no less than 32 in. wide.
 - ii). Overlapping gap closer or bridge plates shall be provided between coupled cars to allow wheeled mobility devices to pass from car-to-car without trapping the wheels in gaps.
- f). Each car with accessible positions and elevators shall include a wheeled mobility device lift on each side of the car's entrance area.

- i). Wheeled mobility device lift for boarding is detailed in Chapter 12.

11.5 Arrangement Flexibility and Modularity

- a). The basic car interior shall be standardized to the greatest extent possible and shall be capable of reconfiguration, upgrade, or replacement without disrupting adjacent interior elements of the car.
- b). All like components and all associated assemblies (e.g. floor panels, bulkheads, side wall & ceiling panels, etc) and their spare parts shall be designed and manufactured to be identical/ interchangeable, both as individual parts and as sub-assemblies, throughout the entire car order production.
- c). All parts shall mount without modification. Replacement parts shall also be interchangeable.
- d). Easy accessibility shall be provided for all items that require periodic maintenance and/or may require replacement.
 - i). Access doors or panels shall be secured using approved captive fasteners or locks.
 - ii). It shall be possible to remove these parts without damage to the individual pieces or adjoining components.
- e). Likewise, it shall be possible to renew any replaceable room component, whether mounted internal or external to the module, without the need to disassemble (except service panels) or remove the module from the car.

11.6 Signage and Labels

- a). The Contractor shall equip each car with adequate signage to provide passengers and crew information about the amenities and safety-related features of the cars.
- b). The signage to be provided shall include, but is not limited to, the following:
 - i). Location of safety equipment
 - ii). Hazards such as high voltage or heat sources
 - iii). Operation of emergency exit equipment
 - iv). Operation of on-board equipment such as doors and door latches/locks
 - v). Amenities such as trash and recycling containers, potable drinking water, 120VAC outlet, etc.
 - vi). Toilet room amenities
 - vii). Seat numbers
 - viii). Capacities for storage locations such as luggage racks and overhead luggage bins

- ix). Service-related signs for maintenance and inspection
- x). Exterior signage for service points
- c). The interior and exterior signage shall conform to Amtrak Specification #697, National On-Board Signage Manual.
 - i). The artwork, material, location, and specifications for each sign shall be submitted to Amtrak for approval at the design review.
- d). Provisions shall be made for all seating and bedroom accommodations to have a safety card stored at each location.
- e). A metallic American flag sign shall be installed in each entrance area of each car. The sign shall be light weight and corrosion free.
- f). Existing Amtrak signs, in accordance with Amtrak Specification #697, shall be used where possible.
 - i). Where new sign designs are required, the Contractor shall develop artwork per the Amtrak Onboard Signage Guidelines and submit to Amtrak for review and approval as part of IDR.
 - ii). The Contractor will provide a signage application drawing for Customer approval identifying all signs and labels used on each car type, including text, as well as the mounting location.
- g). Emergency Signage and LLEPM shall be installed in accordance with APTA Standards PR-PS-S-002-98 and SS-PS-004-99.
 - i). All HPPL signage shall be passive and shall not utilize electric components.
 - ii). The HPPL material shall be charged and shall maintain charge under all lighting conditions except Emergency.
 - iii). All HPPL material shall be charged by method of backlighting and require provisions behind each HPPL signage for an LED light and associated wiring. See Chapter 15.
 - iv). All HPPL shall have drawings for placement with specific part numbers.
- h). Additional signage guidance will be supplied at NTP.

11.7 Interior Noise Levels (Passenger Areas)

- a). Under all specific vehicle and operating conditions listed below, the interior noise levels on any car shall not exceed the sound levels below:
 - i). Vehicle Condition;
 - (1) Completely assembled car
 - (2) No passenger load

- ii). Operating Conditions:
 - (1) Operating in any specified mode of acceleration, deceleration, or coasting at any speed up to 110 mph.
 - (2) On tangent, at-grade, ballast-and-tie track with clean, smooth continuous welded rail,
 - (3) All auxiliaries operating simultaneously at normal conditions
- iii). Measurement Location:
 - (1) Any and all points at least one foot from the ceiling, floor, end walls, or side walls.
- iv). Maximum Sound Levels:
 - (1) 70 Decibels (Acoustic) (dBA) in seating areas,
 - (2) 75 dBA in entrance areas (referred to 0.0002 microbar)
- b). Compliance with this requirement shall be demonstrated using a Type 2 sound level meter as defined by ANSI Standard S1.4: American National Standard Specification for Sound Level Meters, using the slow meter scale.

11.8 Vibration

- a). All trainset equipment shall be designed to operate without damage or degradation of performance when subjected to vibration and shocks encountered during normal service.
- b). All newly designed equipment and auxiliaries mounted anywhere on any car, car body, or trucks within the trainset shall not cause vertical or horizontal vibrations anywhere on the car floor, walls, ceiling panels, and seat frames in excess of:
 - i). 0.10 in. peak-to-peak amplitude,
 - ii). 0.01 acceleration due to gravity (g) peak acceleration for the frequency range from 5 Hertz (Hz) to 14 Hz, and
 - iii). 0.045 in. per second peak vibration velocity for the frequency range above 14 Hz.
- c). Carbody-mounted components shall be designed to withstand vibrations of not less than 0.2 g at frequencies up to 100 Hz and randomly oriented shock loads of 8 g longitudinal, 4 g vertical and 4 g lateral.
- d). Shock and vibration tests shall be conducted in accordance with IEC 61373 (1999) – Railway Application, Rolling Stock Equipment, Shock and Vibration Tests.

11.9 Sanitary Design

a). Cleanability

- i). The car interior and all materials shall be designed so that they do not soil, stain, or show dirt easily.
- ii). Interior materials shall be easy to clean using few tools and little specialized equipment.
- iii). Items such as HVAC grilles shall only require opening to access the ductwork during extensive periodic cleaning.
- iv). The number of items that require removal for cleaning shall be kept to a minimum.
 - (1) Equipment seen by the passenger and crew shall be cleanable in daily service without removal.
 - (2) Those items that must be removable shall be easy to remove and replace, with all like units being interchangeable.
 - (3) Removable items shall employ captive fasteners of a type that will not deteriorate or degrade in effectiveness with use over the life of the car.
 - (4) If screws are used, they shall be easy to line up with the mating hole on the fixed part.

b). Protection from Fluids

- i). Great care shall be taken in design, manufacture and installation of the rooms and equipment to ensure that neither routine use, cleaning, and maintenance, nor leaks and overflows will cause fluids to seep or wick under the module's flooring or between the sub-flooring, walls and car structure.
- ii). All floors and pipe connections, etc., shall be sealed internally to prevent liquids from leaking into the car sub-floor and insulation.
 - (1) This is to avoid sanitation and odor problems and minimize potential for sub-floor corrosion.
 - (2) Sealing design is subject to Amtrak approval.

c). FDA Requirements

- i). Interior design and installation shall meet all applicable requirements of FDA for water, waste, and general sanitation issues.

11.10 Maintenance and Material Performance Expectations

a). Attachment Methods

- i). Strength of all interior fittings and their attachment to the carbody shall meet APTA Standard PR-CS-S-006-98 and 49 CFR Part 238.233.
- ii). Secondary structure shall be provided to securely anchor car interior items that are subject to significant loads, such as handrails, light fixtures, etc.
- iii). In instances where FRP components are used, they shall be stiffened and reinforced appropriately with stainless steel, balsa panels or other materials as approved.
 - (1) Stiffening and reinforcing will be subject to approval by Amtrak for each application.
- iv). All components shall be secured to the car auxiliary structure with machine screws, which engage stainless-steel tapping plates.
- v). Floating nut assemblies may be used if they are part of a tapping plate assembly.
- vi). Nut-inserts (Riv-nuts, Nut-serts etc.) are not an acceptable alternative to tapping plates. Likewise, spring type mountings are not acceptable.
- vii). Where components attach to car interior materials, such as FRP, mounting shall be coordinated so the appropriate provisions are incorporated into the design of those materials.
 - (1) When the component is mounted on FRP, the tapping plate shall be embedded deeply into the FRP behind the primary FRP wall and completely glassed in using woven glass fabric and resin, so it never loosens for the life of the car.
 - (2) Mounting holes can be incorporated into the panels to which the components are mounted or drilled in place using a template.
 - (3) Match drilling using the component as a template is not acceptable.
 - (4) Components should be mounted from the exposed side of the mounting surface so that the component can be removed for repair or replacement from the front.
 - (5) Provisions are required to prevent squeaking between the component and mounting.

b). Access Panels

- i). Easy access shall be provided for all items that require periodic maintenance, defect repair or replacement.

- ii). Panels/ doors covering this equipment shall be hinged, where possible and fastened with approved captive fasteners in a manner that permits these activities.
- iii). Safety catches shall be provided for access panels/doors to prevent sudden or accidental deployment.
- iv). Window masks shall allow for easy window replacement.
- c). Junction Boxes
 - i). Junction boxes shall be located within electric lockers or hidden behind access panels. See Chapter 15 for additional information.
- d). Time to Repair/ Replace
 - i). All lowest replaceable units LRUs shall be replaceable in less than 30 minutes by a single maintenance worker. See Chapter 4 for additional information.

11.11 Safety

- a). Fire Safety
 - i). The builder shall provide a Fire Safety Analysis for Amtrak review and approval, in accordance with APTA RP-PS-005-00. See Chapters 19 and 25.
 - ii). All interior materials shall meet the flammability and smoke emissions requirements of Amtrak Specification # 352 (which incorporates references to 49 CFR 238.103).
 - iii). Test reports from an independent lab showing compliance with Amtrak Specification # 352 shall be provided in advance of related FAI's.
- b). Injury Prevention
 - i). The car interior shall be designed to provide a safe, comfortable, and convenient functional environment to the passengers, crew, and maintenance staff.
 - ii). Interior design shall integrate the car sidewall, transverse wall, window mask, ceiling, and other interior surfaces into a harmonious unit.
 - iii). Generously rounded edges and corners, to guard against personnel injury by passengers, crew, and maintenance staff shall be provided.
 - iv). The use of visible fasteners shall be kept to a minimum, and where used, be inconspicuous.
- c). Pinch points
 - i). Gaps smaller than 1.5 inches, and larger than 0.5 inches shall be considered potential pinch points that shall be avoided to the maximum extent possible.

- (1) Exceptions can be presented to Amtrak if the gap surface depth is less than 0.5 inches.
- ii). The Contractor shall develop and submit a Pinch Point Gap Analysis **[CDRL 11-02]** document that identifies all potential pinch points and justifications.
 - (1) The analysis shall be submitted for Final Design Review FDR approval.

Part II: Interior Components

11.12 Doors and Latches

- a). Relevant information for doors and latches as they pertain to interiors is generally described below.
 - i). Further information for doors and latches can be found in Chapter 12.
- b). All interior doors shall be built of robust materials to withstand repeated use without deforming or losing adjustment.
- c). Doors, unless otherwise indicated as sliding doors, shall have a minimum of three stainless steel heavy-duty hinges or one continuous piano hinge and shall open outward into the interior of the car unless specified otherwise.
- d). All latches and hinges shall be stainless steel piano hinges unless approved by Amtrak during the design review process.
- e). Access panel doors shall have stainless-steel piano hinges.
- f). Cabinet doors shall be supplied with lanyard or equivalent door limiting mechanism to ensure that no collisions occur between cabinet doors and other components of the train.
 - i). Doors with lanyards shall be limited to 130 degree opening as a default setting with minimal adjustment. Lanyards shall be removable without the use of special tools.
- g). Doors shall close securely without requiring the use of a key and shall remain closed without rattling or becoming loose during operation.
- h). As necessary for proper airflow in each car according to the HVAC design, doors shall have a grille located in the lower half of the door panel for air circulation.
- i). Electrical locker and utility locker doors shall have a release lever on the inside of the latch.
- j). Doors that have passenger safety equipment behind them shall use paddle latches with no locking mechanism. Please refer to Chapter 18 for more information regarding emergency equipment.
- k). Doors that cover PA handsets shall only have one latch or lock for access.

11.13 Windows

- a). See requirements of Chapter 6 and Chapter 19.

11.14 Window Masks

- a). The window masks shall be either Fiberglass Reinforced Plastic (FRP) or thermoformed plastic.

- b). The window edge should incorporate openings for heating vents at the window and shall not interfere with minimum accessible clearance requirements.
- c). Sidewall heat vents may be separate powder coated aluminum (as appropriate for the mask to window interface), or integral to the window mask.
- d). The window masks must not readily collect dust/dirt and shall be easy to clean without removal or special tools.
- e). Window masks shall be wrapped in a protective film in accordance with Chapter 19. Paint is prohibited.
- f). Panel construction shall allow for removal and recovering of the surface covering at overhaul without damage to the base material.
- g). Window masks shall allow for easy window replacement.

11.15 Window Blinds

- a). Coach Side Windows and Skylight windows shall be provided in conjunction with blinds.
- b). Blinds shall be replaceable within a 30 min timespan.
- c). Two types of pull-down blinds shall be provided:
 - i). An outside sunshade shall provide daytime protection
 - ii). A second inside black out blind shall cut out all light and provide complete privacy.
- d). The outside and inside blinds shall work individually or in combination, so they provide two layers of shade.
- e). Operation
 - i). Coach side window blinds shall be operated manually by a passenger.
 - ii). Skylight window blinds shall be automated so that the conductor can deploy or retract the blinds at the push of a button.

Part III: Storage Areas

11.16 Storage in Coach Areas

- a). Each storage location below shall integrate into the coach area in an inconspicuous manner and shall flow seamlessly with the aesthetic of the rest of the coach car.
- b). Each storage location shall be clearly labeled according to Amtrak Specification #697.
- c). Each storage location shall be easily opened and accessed by any passenger and the use of paddle latches or push-button latches is desired.
- d). Folded Wheeled Mobility Device storage spaces shall be dedicated for at least two devices per car along the accessible path for passengers wishing to transfer to another seat.
- e). Storage space for an evacuation chair shall be included. Please refer to Chapter 29.
- f). Emergency Equipment listed below shall have appropriate storage locations within the coach car. Please refer to Chapter 18 for more information regarding emergency equipment.
 - i). Trauma Kit and Stretcher
 - ii). Egress Ladder
 - iii). AED
 - iv). First Aid Kits

11.17 Trash and Recycling Storage

- a). General:
 - i). Trash and Recycling Receptacles shall be provided on each car type in conspicuous locations to encourage passenger/crew use.
 - ii). Recycling and trash receptacles shall be provided on both ends of each car type as close as practical to stair and restroom areas.
 - iii). The recycling and trash receptacles shall be either side-by-side in a row or directly across the aisle from one another.
 - iv). The recycling and trash receptacles shall meet all FDA and NSF requirements for trash containers and their materials.
 - v). To the extent possible, these receptacles will be designed to maximize trash capacity or at a minimum accommodate the Amtrak standard trash container, per Amtrak Drawing C-96-7591.

- vi). The receptacles shall be boldly labeled with an intuitive icon for type of trash, in accordance with Amtrak Specification # 697.
 - vii). The inside of each trash receptacle door shall be permanently labeled with the Amtrak AMMPS number of the container required for that space.
 - viii). Each set of receptacles shall include two separate openings and respective bins:
 - (1) one for trash
 - (2) one for recyclables (cans, bottles, and newspapers)
 - ix). Openings for these receptacles shall be designed to encourage passengers to use the proper receptacle for disposing of trash and recyclables, through the use of distinctive opening designs and signage.
- b). Material and Construction:
- i). Trash and recycling locker door panels shall have melamine or factory-applied laminate.
 - (1) Alternatively, panels may be constructed of honeycomb or plymetal wall materials.
 - ii). The trash locker container access door shall be secured closed with a square lock.
 - iii). The trash locker door shall include a recessed grab handle to be used to pull the door open when unlatched.
 - iv). Visible hardware and fasteners shall be minimized to aid cleaning, reduce build-up of contaminants, and provide for pleasing aesthetics.
 - v). Recycling and trash receptacle lockers shall be of panel construction with substructure as appropriate to support components.
 - vi). The locker shall include appropriate brackets and/or guides, etc. to properly index the trash containers with the openings, and as required, to keep them upright.
 - (1) These devices shall be rounded, etc. to protect staff handling the containers or servicing the end door from injury.
 - vii). The locker enclosure with walls & door material be fireproof or be lined with fire-resistant material.
 - viii). The locker shall use as few joints as possible in fabrication; they shall be permanently sealed against moisture and vermin.
 - ix). The locker shall be structurally sound and conform to requirements set out in 49 CFR 238.233.

- c). Cleanability:
 - i). The inside of the trash locker shall be easy to clean, with large 0.75 in radius sanitary corners and all joints sealed for good sanitation and to meet FDA requirements.
 - ii). Visible hardware and fasteners should be minimized to aid cleaning, reduce build-up of contaminants, and provide for pleasing aesthetics.
 - iii). Easy to clean trash guides shall be provided on the sides and back of the locker and on the inside of the locker door. The trash guides shall prevent trash and liquids from getting between the container and locker wall.
 - iv). Horizontally accessed recycling and trash receptacles shall include a hinged self-closing door flap of a touch-free design that is as large as practical.
 - (1) This flap shall be as wide as possible.
 - (2) It shall be possible to open the trash flap by pushing against the vertical surface and further provide for opening without touching the vertical surface.
 - (3) If possible, the flap should be attached to the locker top surface rather than a door-within-a-door concept.
 - (4) Spring tension of a stainless-steel spring should prevent the door from swinging/ banging as a result of train motion.
 - (5) These flaps shall avoid trapping any hands or fingers.
 - v). Vertically accessed recycling and trash receptacles shall have clear openings without flappers.
 - (1) Enclosure shall be constructed so as to not ignite, produce lingering char, or allow fire to spread to adjacent interior elements.
- d). Required Tash and Recycling Volumes
 - i). Figure 11-1 defines required trash and recycling capacity volumes in each section of the trainset:
 - ii). Note a limitation of this table is that quantity of each location type is defined in Chapter 1. Therefore, a cumulative trash volume for the trainset is not calculated in this table.

Figure 11-1: Trash and Recycling Quantities

Section	Location	Type	Volume
Coach	Entrance Area	Trash and Recycling	7.5 cu ft
	General	Trash and Recycling	20 cu ft
	Accessible Toilet Room	Trash Only	2.25 cu ft
	Standard Toilet Room	Trash Only	2 cu ft
	Lactation Room	Trash Only	0.75 cu ft
Sleeper	Roomette	Trash Only	0.75 cu ft
	SoloSuite	Trash Only	0.75 cu ft
	Club Bedroom	Trash Only	1 cu ft
	Premium Bedroom	Trash Only	1 cu ft
	Accessible Twin	Trash Only	1 cu ft
	Accessible Double	Trash Only	1 cu ft
	Accessible Premium Bedroom	Trash Only	1 cu ft
Food Service	Kitchen	Trash and Recycling	44 cu ft
	Servery	Trash and Recycling	24 cu ft
	First Class Bar	Trash and Recycling	8 cu ft
	Cafe	Trash and Recycling	20.25 cu ft
Lounge	General	Trash and Recycling	20 cu ft
Diner	General	Trash and Recycling	10 cu ft
Cafe	General	Trash and Recycling	20 cu ft
Utility	General	Trash and Recycling	10 cu ft
Crew	Crew Room	Trash Only	0.75 cu ft
	Crew Common Area	Trash and Recycling	10 cu ft

11.18 Linen Closets

a). General

- i). Linen closets shall be located on each car that contains a sleeping compartment.
- ii). Linens shall be stored in a full height cabinet that is at least 2.5 ft wide and 2 ft deep.
- iii). This cabinet shall have adjustable shelving and retaining devices to hold equipment on the shelf.
- iv). The closet shall have a light that turns on when the door is opened and light switch inside.
- v). The cabinet shall also have a duplex service outlet.

b). Material and Construction:

- i). Linen closet door panels shall have melamine or factory-applied laminate.

- (1) Alternatively, panels may be constructed of honeycomb or plymetal wall materials.
 - ii). Adjustable shelves with retaining bars shall be provided in these linen closets.
 - iii). A minimum of 5 shelves per closet shall be the default for the linen closet design and the final number of shelves and installed spacing arrangement shall be determined at the mockup review.
- c). Cleanability:
- i). The inside of the linen closet shall be easy to clean, with large 0.75 in radius sanitary corners and all joints sealed for good sanitation and to meet FDA requirements.
 - ii). Visible hardware and fasteners should be minimized to aid cleaning, reduce build-up of contaminants, and provide for pleasing aesthetics.

11.19 Consumable Supply Closet

- a). General:
- i). Consumable supplies shall be stored in a full height cabinet that is at least 2.5 ft wide and 2 ft deep.
 - ii). One consumable supply cabinet shall be provided per car.
 - iii). This cabinet shall have adjustable shelving and retaining devices to hold equipment on the shelf.
 - iv). The cabinet shall have a light that turns on when the door is opened and light switch inside.
 - v). The cabinet shall also have a duplex service outlet.
- b). Material and Construction:
- i). Consumable Supply locker door panels shall have melamine or factory-applied laminate.
 - (1) Alternatively, panels may be constructed of honeycomb or plymetal wall materials.
 - ii). Adjustable shelves with retaining bars shall be provided in these consumable supply closets. A minimum of 8 shelves per closet shall be the default for the consumable supply closet design and the final number of shelves and installed spacing arrangement shall be determined at the mockup review.
- c). Cleanability:

- i). The inside of the consumable supply locker shall be easy to clean, with large 0.75 in radius sanitary corners and all joints sealed for good sanitation and to meet FDA requirements.
- ii). Visible hardware and fasteners should be minimized to aid cleaning, reduce build-up of contaminants, and provide for pleasing aesthetics.

11.20 Cleaning Supply Cabinet

a). General

- i). Cleaning supplies shall be stored in a full height cabinet that is at least 2.5 ft wide and 2 ft deep.
- ii). One cleaning supply cabinet shall be provided per car.
- iii). This cabinet shall have adjustable shelving and retaining devices to hold equipment in place and/or on the shelf.
- iv). An onboard vacuum with a long extension hose shall be permanently mounted within the cleaning cabinet.
 - (1) The vacuum hose shall extend the length of the car.
- v). Provisions shall be made for retention of one broom, one dustpan, one mop, and one mop bucket.
- vi). The cabinet shall have a light that turns on when the door is opened and light switch inside.
- vii). The cabinet shall also have a duplex service outlet.

b). Material and Construction:

- i). Cleaning Supply Cabinet door panels shall have melamine or factory-applied laminate.
 - (1) Alternatively, panels may be constructed of honeycomb or plymetal wall materials.
- ii). Adjustable shelves with retaining bars shall be provided in these cleaning supply cabinets.
- iii). A minimum of 3 shelves per cabinet shall be the default for the cleaning supply closet design and the final number of shelves and installed spacing arrangement shall be determined at the mockup review.

c). Cleanability:

- i). The inside of the cleaning supply cabinet shall be easy to clean, with large 0.75 in radius sanitary corners and all joints sealed for good sanitation and to meet FDA requirements.

- ii). Visible hardware and fasteners should be minimized to aid cleaning, reduce build-up of contaminants, and provide for pleasing aesthetics.

11.21 Emergency Equipment

a). General:

- i). Emergency Equipment boxes shall be mounted in each level of each car.
- ii). These boxes shall contain, at a minimum:
 - (1) a fire extinguisher
 - (2) crowbar
 - (3) hammer
 - (4) snap lights
 - (5) first aid kit.
- iii). Emergency equipment boxes shall not be locked and be mounted in an area easily accessible to all passengers in the event of an emergency.
- iv). The labels and gages for the fire extinguisher shall be visible and readable from either a seated or standing passenger in an aisle.
- v). Further information on these emergency equipment boxes can be found in Chapter 18.

b). Material and Construction:

- i). Emergency equipment locker door panels shall have melamine or factory-applied laminate.
 - (1) Alternatively, panels may be constructed of honeycomb or plymetal wall materials.

c). Cleanability:

- i). The inside of the emergency equipment locker shall be easy to clean, with large 0.75 in radius sanitary corners and all joints sealed for good sanitation and to meet FDA requirements.
- ii). Visible hardware and fasteners should be minimized to aid cleaning, reduce build-up of contaminants, and provide for pleasing aesthetics.

11.22 Luggage Storage - General

a). General:

- i). Luggage racks shall conform to 49 CFR 238.737.
- ii). The Contractor shall factor in:

CONFIDENTIAL — DO NOT DISTRIBUTE

- (1) Safety
 - (2) Crashworthiness, abuse, load, and crash criteria
 - (3) Materials and Workmanship
 - (4) FDA cleaning clearances
 - (5) Radii
 - (6) Sanitary design.
- iii). All mechanisms should be durable, free from jamming, and racking.
 - iv). Dimensions, position, and usability will be subject to Amtrak approval during the mockup review.
- b). Cleanability:
- i). The inside of the luggage storage locations shall be easy to clean, with large 0.75 in radius sanitary corners and all joints sealed for good sanitation and to meet FDA requirements.
 - ii). Visible hardware and fasteners should be minimized to aid cleaning, reduce build-up of contaminants, and provide for pleasing aesthetics.
- c). Required Luggage Storage Volumes and Baggage Analysis
- i). Figure 11-2 defines required luggage storage locations in each section of the trainset
 - ii). Baggage storage volumes shall comply with Amtrak Baggage Policy.
 - iii). As part of PDR, the Contractor shall develop and provide an analysis of how the proposed car arrangements and trainsets shall comply with the Amtrak Baggage Policy. **[CDRL 11-03]**

Figure 11-2: Required Luggage Storage Locations

Section	Location	Type
Coach	Standard	Overhead
		Luggage Rack
Coach	Premium	Overhead
		Luggage Rack
Utility	Checked Baggage Bay	Open
		Luggage Rack
		Bicycle
Sleeper		Luggage Rack

d). Key Features

- i). Expected features for Luggage Storage areas are summarized in Figure 11-3 and detailed below.

Figure 11-3: Luggage Storage Key Features

Feature	Short Description	Qty
Trim Panels	Wall panel with provisions for mounting lighting, signage etc	NA
Display Screen	Monitor screen for digital information	At least 1
Class Signifier	Accent color stripe	1
Rollstop	Retaining bar for luggage	1 per shelf
Glass Side Panel	Safety glass	At least 1
Kick Strips	Stainless steel strips	each exposed side
Solid Panel	HPL panel	NA
Upper Shelf	Shorter depth shelf	1
Protective Back Panel	Replaceable wear panel	depends on shelf quantity
Shelves	Full depth shelf	TBD
Bottom Shelf	Floor luggage storage for large bags	1
Lighting	Indirect lighting	1 per shelf level

ii). Trim Panels

- (1) Trim panels shall interface with side wall and ceiling with no gaps or dirt traps.
- (2) Trim panels are made from HPL composite sandwiches.

iii). Display Screen

- (1) A display screen shall be provided as an option for integrated passenger information screen, (PIS/OTIS).

iv). Class Signifier

- (1) Color anodized aluminum trim shall signal class of travel.

v). Rollstop

- (1) Retaining bars or similar detail shall be provided on large shelving edges that prevent luggage from falling or rolling out.

vi). Glass Side Panel

- (1) Safety glass side panels shall be used for easy view of passenger luggage from seated positions.

- vii). Kick Strips
 - (1) Stainless steel kick strips at 9" high should be used on all exposed edges.
- viii). Solid Panel
 - (1) A solid panel with HPL skin and no safety glass should be used when stacks are placed up against bulkheads.
- ix). Upper Shelf
 - (1) Upper shelf can be shallower for smaller bags and aid in passenger reach of luggage.
- x). Protective Back Panel
 - (1) Replaceable trim panel that protects wall from scuffing shall be provided. Panel should be easy to replace.
- xi). Shelves
 - (1) Shelving with hard wearing finish shall be provided. Shelf should be easily replaceable, easy to clean, with no dirt traps.
- xii). Bottom Shelf
 - (1) The bottom shelf shall be deep enough for large suitcases. It shall have an easy clean surface, no dirt traps, and a soft back corner.
- xiii). Lighting
 - (1) Wash lighting shall be provided at each shelf of the rack and controlled by boarding mode.

11.23 Overhead Luggage Storage

- a). General
 - i). Overhead luggage storage racks shall be provided above all revenue coach and premium coach seating unless skylight windows are provided in the ceiling above the coach seat.
 - ii). Overhead luggage storage shall incorporate dividers to prevent excessive shifting/movement of luggage.
 - iii). The luggage racks shall consist of modular units bolted to the sidewall and roof structure and extend the entire length of the passenger seating compartment.
 - iv). The racks shall accommodate carry-on luggage of up to 14 in. x 9 in. x 22 in. in size and smaller personal items.

- v). Length of the racks shall match the window pitch so that the bin dividers are centered on the pillar between windows.
 - vi). Design of the racks shall include as few obstructions as possible for manipulating luggage into and out of the rack.
 - vii). The luggage bearing surface shall be durable and not require replacement or refurbishment for the life of the car.
 - viii). The lower edge of the rack at the aisle shall incorporate a smooth convex radius to mitigate passengers bumping their heads against the underside of the luggage bin.
 - ix). An easily reached continuous passenger handhold shall be provided facing the aisle way.
- b). Strength and Attachment
- i). The rack structure and attachment to carbody structure shall have sufficient strength to support a load of 250 lbs., applied over a 10 in. by 10 in. area, midway between adjacent supports with a deflection not to exceed 0.25 in. (including rack itself and its attachment to carbody) and without fracture or permanent deformation.
 - ii). The load-bearing surface shall be inclined upward from the horizontal toward the center of the car at an angle of approximately three degrees.
 - iii). The complete and fully loaded luggage rack and its attachment to the carbody shall be designed to resist loads, without failure, due to accelerations of 8g longitudinally 4g laterally and 4g vertically, acting on the mass of the luggage.
 - iv). The contractor shall demonstrate the strength and luggage retention capability of the luggage racks during the design review.
- c). Reading Lights
- i). Track-mounted reading light assemblies, as described in Chapter 13 may be mounted on the underside of the racks, with the entire installation arranged on the bottom side of the racks.
 - ii). The design shall allow the light fixture units to be moved in small increments longitudinally along the luggage rack to allow it to be centered above each passenger seat pair, regardless of seat pitch.
 - iii). The luggage rack shall be equipped with a wiring chase or equivalent that provides the flexibility in wiring to achieve this.
 - (1) Alternate arrangements may be proposed for Amtrak review.
 - (2) Reading lights shall only be mounted under the luggage racks in locations designated as accessible seating areas.

- d). Overhead Luggage Storage Racks are described in detail in Section 11.23.

11.24 Luggage Towers

- a). General
 - i). Quantity and location of luggage towers shall be guided by the information presented in Chapter 1 as well as the compliance with the Baggage Analysis required in Section 11.22.
- b). Materials and Construction
 - i). A luggage tower shall be of robust stainless-steel construction and include shelves.
 - ii). Bumper guards shall be mechanically attached to the wall panels within the luggage tower to prevent damage to walls or luggage.
 - iii). The towers shall have sufficient strength to support a load of 250 lbs. midway between adjacent supports with a deflection not to exceed 0.25 in. and without permanent deformation.
 - iv). The load-bearing surface shall not be less than 24 in. wide and shall be inclined upward from the horizontal toward the center of the car at an angle of approximately three degrees.
- c). Aesthetics
 - i). The towers shall have decorative graphics and patterns etched or placed on the glass panels.
 - ii). Exact graphics, decals, opacity, etc. shall be determined with Amtrak during the design review process.
- d). Luggage Tower Types and Use
 - i). Three luggage tower types are acceptable (see descriptions below):
 - (1) Luggage Tower 1
 - (2) Luggage Tower 2
 - (3) Alcove Tower
 - ii). Use and quantity of each luggage tower type shall be determined by the Contractor and approved by Amtrak during the design review process.
 - iii). To the best extent possible, luggage tower 2 shall be utilized throughout the trainset and deviations from luggage tower 2 are subject to Amtrak approval.
- e). Luggage Tower 1
 - i). Luggage towers should be built as a modular set of parts.

- (1) A general illustration is provided in Figure 11-45 on page 11-305.
 - ii). Various lengths of luggage tower shall be allowed for within the same modular construction.
 - iii). Luggage towers should be integrated with the side wall and ceiling with no gaps or dirt traps between it and the adjoining body side panels.
 - iv). Glass side panels made from safety glass shall be provided that present a clear view of luggage from seated positions.
- f). Luggage Tower 2
- i). Luggage Tower 2 style shall have a modular design that fully integrates a screen.
 - (1) A general illustration is provided in Figure 11-46 on page 11-305.
 - ii). Screens should not be bolted on, but fully integrated and flush with the external glass.
 - iii). The back of the screen should be fully protected from bags and easy to access for maintenance.
 - iv). It is acceptable that in these conditions the screen covers the top shelf; the lower portion should remain glass made from safety glass.
- g). Alcove Luggage Tower
- i). A general illustration is provided in Figure 11-47 on page 11-306.
 - ii). Alcove luggage towers should be designed so they can be free standing in coach cars to provide a draft screen or bulkhead arrangement or integrated into alcoves with the same set of modular shelving and the same general aesthetic and lighting.

Part IV: Integrated Electronics and Technology

11.25 Digital Displays

a). General

- i). Digital displays shall be provided throughout the trainset.
- ii). Displays shall be capable of both displaying uniform content across multiple screens and displaying unique information.
 - (1) This should be adjustable by Amtrak employees who have access to software passwords for such activities.
- iii). See Chapters 14 and 26 for additional information and requirements for displays.

b). Materials and Construction

- i). All display screens shall be rail rated and/or service proven.
- ii). Displays shall be integrated into an access panel for ease of maintenance and replaceability.
- iii). Behind each access panel should be provisions for electrical, diagnostics, and communications connections even if the display screen is only powered by the Contractor.
- iv). Displays shall be flush mounted unless otherwise agreed with Amtrak during IDR and Mockup Review.

c). Required Screen Quantities

- i). The required type and quantity of display screens in each section of the trainset is summarized in Figure 11-4 on page 11-29.
 - (1) Note a limitation of this table is that quantity of each location type is defined in Chapter 1; therefore, a cumulative number of displays for the trainset is not calculated in this table.

d). Screen Placement

i). General

- (1) The screen placement shall meet the location-specific conditions listed below.
- (2) Please refer to CMF and suggested layout attachments for further information on screen placement and examples.

ii). Entrance Areas

- (1) In all entrance areas there should be portrait screens on both sides of the door.
- iii). Premium Coach Cars
 - (1) In premium coach cars with no luggage racks, screens should be positioned on one side of partition doors on all available bulkheads.
 - (2) The screens should be positioned as high as possible and above a seated head height of a 95th percentile male.
- iv). All Coach Cars
 - (1) **Applicability:** all coach cars, including End, Standard and Premium Coach Cars.
 - (2) In coach cars where height allows or where there is an end bulkhead (e.g. lower level of car), screens should be positioned central and high to the car.
 - (3) In coach cars which have luggage racks and where height is limited, screens should be positioned above seat height and below the lowest level of the luggage rack.
 - (a) In this condition there should be screens on both sides of the partition door.
 - (b) If screen height is limited, wide aspect ratio screens should be supplied.
 - (4) In coach cars where there is a luggage tower blocking the bulkhead or ending the seating areas, portrait screens should be integrated with luggage racks.
 - (a) Screens should be set as high as possible and above seated head height of a 95th percentile male.
 - (5) At the top of all staircases there should be a screen primarily used for navigation.
 - (a) In this condition there should be screens on both sides of the portion door.
 - (b) Where screen height is limited, wide aspect screens should be specified.
 - (6) At each end of coach car where height and width permit, a high-level scrolling screen should be used.
- v). Sleeper Cars
 - (1) At each end of all sleeper car hallways, a portrait screen should be provided for passenger information and way finding. (PIS/OTIS)

vi). Food Service Areas

- (1) In food service areas where screens are used for digital menus, screens should be placed so they can be read at multiple locations including in queuing spaces and directly at point of purchase.

Figure 11-4: Required Display Screens

Section	Location	Screen Orientation	Screen Size	Screen Ratio	Quantity
All Cars	Top of Stairs	Portrait	36"	16:9	1 per stairway
	Entrance Area	Portrait	29"	16:9	2 per entrance area
Coach	All Seating Areas	Landscape	7"	4:3	1 per set of seats
	Premium Seating Area	Landscape	32"	16:9	1 per location without luggage racks
	Standard Seating Area	Landscape	21"	21:9	1 per bulkhead on lower level
		Portrait	29"	16:9	1 per luggage rack
		Landscape	21"	21:9	2 per bulkhead
	All Scrolling Screens Ceiling Mounted	Landscape	28"	16:3	At least 2 per level per car where applicable
	Accessible Toilet Room (ATR)	Portrait	36"	16:9	1 on side wall of restroom
	Standard Toilet Room (STR)	Portrait	36"	16:9	1 on side wall of restroom
	Lactation Room	NA	NA	NA	NA
Sleeper	Hallways	Portrait	36"	16:9	2 per hallway (one at each end)
	Outside Room	Landscape	7"	4:3	1 per room
	Roomette	Landscape	9"	16:9	1 per room
	SoloSuite	Landscape	9"	16:9	1 per room
	Club Bedroom	Landscape	9"	16:9	1 per room
	Premium Bedroom	Landscape	9"	16:9	1 per room
		Landscape	43"	16:9	1 per room
	Accessible Twin	Landscape	9"	16:9	1 per room
		Landscape	21"	16:9	Passenger Information Screen 1 per room (PIS/OTIS)
	Accessible Double	Landscape	9"	16:9	1 per room
		Landscape	21"	16:9	Passenger Information Screen 1 per room (PIS/OTIS)
	Accessible Premium Bedroom	Landscape	9"	16:9	1 per room
		Landscape	21"	16:9	Passenger Information Screen 1 per room (PIS/OTIS)

Figure 11-4: Required Display Screens (continued)

Section	Location	Screen Orientation	Screen Size	Screen Ratio	Quantity
Food Service	Kitchen	Portrait	32"	16:9	1 dedicated to Kitchen POS
	Servery	Portrait	32"	16:9	2 dedicated to servery digital menus
	First Class Bar	NA	NA	NA	NA
Lounge	General	Portrait	32"	16:9	2 dedicated to lounge
Diner	General	Portrait	32"	16:9	4 dedicated to diner
Cafe	General	Portrait	32"	16:9	4 dedicated to café
Utility	General	NA	NA	NA	NA
Crew	Crew Common Area	Portrait	32"	16:9	2 dedicated to crew

11.26 Keyless or Card Access

- a). General
 - i). An electronic door locking mechanism shall be implemented into doors for passenger access areas as listed in Figure 11-5.
 - ii). This locking mechanism shall default to the unlocked position with loss of power as a safety feature.
 - iii). The locking mechanism shall allow for keyless and keycard entry through the use of RFID, Bluetooth, or Amtrak approved technology.
 - iv). See Chapters 14 and 26 for additional information and requirements for keyless access.
- b). Materials and Construction
 - i). All entry readers shall be rail rated and/or service proven.
 - ii). Keyless entry or keycard readers shall be integrated into an access panel for ease of maintenance and replaceability.
 - (1) Behind each access panel should be provisions for electrical, diagnostics, and communications connections even if the reader is only powered by the Contractor.
- c). Required Locations
 - i). Locations where keycard and keyless entry are required in each section of the trainset is summarized in Figure 11-5.
 - ii). Note a limitation of this table is that quantity of each location type is defined in Chapter 1 of this specification.
 - iii). Therefore, a cumulative number of readers for the trainset is not calculated in this table.

Figure 11-5: Required Keycards and Locations

Section	Location
Coach	Lactation Room
Sleeper	Roomette
	SoloSuite
	Club Bedroom
	Premium Bedroom
	Accessible Twin
	Accessible Double
	Accessible Premium Bedroom
Crew	Crew Room

11.27 Electrical Locker and Panels

- a). The car electric/ switch locker shall be located within the car interior.
- b). The car PA unit is located here, recessed into the wall.
- c). The locker shall have separate doors for crew operated equipment, and maintenance operated equipment. See Chapter 15.
- d). Locker walls shall be of melamine faced aluminum panel construction with substructure as appropriate to support components.
- e). Longitudinal walls facing into the entrance area shall be decorated with melamine or other factory-manufactured laminate material.
- f). The locker wall & door material be fireproof or be lined with fire-blocking material.
- g). The substructure shall be robust to support the numerous heavy electrical panels, etc. located within the locker.
- h). The door and frame shall be robust due to frequent use and rough treatment.
- i). The door lock shall be a coach key style lock with interior release latch.
- j). The electrical locker shall be positively pressurized by conditioned air as part of the HVAC system to prevent dust from entering and accumulating in the electrical locker.
- k). Air shall only be allowed to vent from the electrical locker through gaps and voids where dust may enter.
- l). There shall not be a vent or grille in the door to the electrical locker.
- m). The locker shall include a metal pocket or rack to hold the car defect report book, which is approximately 8.5 in. wide by 11 in. tall by 1 in. thick.
- n). The inside face of the electrical locker door shall have an identification sign listing the car number, car weight and freshwater capacity, and an 8.5 in. wide by 11 in. tall metal surface for an FDA inspection form and stickers.
- o). The surface must be smooth to allow pasting up maintenance forms i.e. extermination
- p). A train-level Central Diagnostic Unit control and display shall be included in the locker
- q). The electric locker door shall be labeled in compliance with Amtrak Specifications # 696 & 697.
- r). When the door is opened, the locker service lights shall be illuminated by magnetic switches.
- s). The locker doors shall be hinged to open to not block aisleways/passageways

- when open.
- t). The passage side of the electric locker with the door shall contain all crew and emergency controls in one location to facilitate emergency preparedness and response.
 - u). At a minimum the following components shall be located on the passage side of the electric locker:
 - i). B-end emergency fan switch
 - ii). B-end body end door cutout switch
 - iii). B-end conductors emergency brake valve (Note: exhaust of valve must not direct onto electrical equipment in the locker, so as to avoid blowing water onto it when valve is activated)
 - iv). PA unit (sleeper and bag/dorm only), (see Chapter 14)
 - v). Fire extinguisher enclosure (see Chapter 18)
 - vi). Smoke Detector main display panel and controls, behind a transparent door, accessed with a coach key (see Chapter 25)
 - vii). Waste system status (see Chapter 17)
 - viii). System status indicator panel (See Chapter 10)
 - ix). All other crew operated emergency controls.
 - v). At the top of the room adjacent to the hallway, each room shall be equipped with an electrical junction box, containing a series of terminal blocks to allow the interconnection of room module wiring with that of the car.
 - w). Overhead wire ducts shall carry inter-module wiring as well as the feeds from the switch locker.
 - x). The cover of the box shall make a dust-tight seal to the room interior and shall be secured with captive screws.
 - y). The electrical equipment and switch locker shall be located as appropriate near the end of each car in the trainset.
 - z). A small switch locker shall be incorporated into the electrical locker, containing just the essential lighting and other control switches needed by the train crew for car setup for trainset operation.

11.28 Outlets

- a). General
 - i). Convenience outlets utilizing duplex receptacles as described in Section 15 shall be located throughout the interior.

- ii). A “120 Volts” label, in accordance with Amtrak Spec. # 697, shall be installed at each outlet location, 0.5 inch from the outlet.
- b). Passenger Convenience Outlets
 - i). Seat Outlets
 - (1) A duplex receptacle shall be provided for each seat, including those at tables, in all car types. See the following sections for additional information:
 - (a) 11.40: Standard Coach Seats
 - (b) 11.41: Premium Coach Seats
 - (c) 11.48: Roomette
 - (d) 11.49: SoloSuite
 - (e) 11.50: Club Bedroom
 - (f) 11.51: Premium Bedroom
 - (g) 11.52: Accessible Twin
 - (h) 11.53: Accessible Double
 - (i) 11.54: Accessible Premium Bedroom
 - (j) 11.68: Lounge
 - (k) 11.71: Lactation Room (Option)
 - (l) 11.77: Crew Sleeper Cabin
 - (m) 11.78: Conductor Office
 - ii). Table Outlets
 - (1) A duplex receptacle shall be installed on each side of each table, located such that the table or seat does not interfere with access to the outlet.
 - iii). Mirror Outlets
 - (1) A duplex receptacle shall be installed adjacent to each mirror. See the following sections for additional information:
 - (a) 11.45: Standard Toilet Room (STR)
 - (b) 11.46: Accessible Toilet Room (ATR)
 - (c) 11.48: Roomette

- (d) 11.49: SoloSuite
- (e) 11.50: Club Bedroom
- (f) 11.51: Premium Bedroom
- (g) 11.52: Accessible Twin
- (h) 11.53: Accessible Double
- (i) 11.54: Accessible Premium Bedroom
- (j) 11.55: Sleeper Cabin Restrooms
- (k) 11.56: Sleeper Cabin Showers
- (l) 11.77: Crew Sleeper Cabin
- (m) 11.80: Crew Restroom
- (n) 11.81: Crew Shower

11.29 Seat Reservation

- a). A comprehensive seat reservation system shall be provided that is integrated into the trainset and controlled by the Onboard Train Information System.
- b). The system shall be capable of displaying both availability of seats as well as reservation information in a clear to read display.
- c). Visible indicators of seat occupancy shall be provided and may be located on the luggage rack in the coach cars and outside each room in the sleeper cars.
- d). The system shall be capable of receiving near-real-time updates on a seat-by-seat basis at all points of a trip via secure API from ground.
- e). The seat reservation system shall be reconfigurable to match seat pitch and location and shall be approved during Design Review.
- f). All communications equipment shall meet the requirements in Section 14, Communications. See also Chapter 24.
- g). Track-mounted seat reservation displays are preferred and may be mounted on the underside of the overhead luggage racks, with the entire installation arranged on the bottom side of the racks.
- h). The design shall allow the reservation display units to be moved in small increments longitudinally along the luggage rack to allow it to be centered above each passenger seat pair, regardless of seat pitch.
- i). The luggage rack shall be equipped with a wiring chase or equivalent that provides the flexibility in wiring to achieve this.

- j). Alternate arrangements may be proposed for Amtrak review especially if the seat is located beneath a skylight and consequently there is no overhead luggage rack.

11.30 Video Surveillance

- a). An onboard digital video surveillance system shall be provided.
- b). The video surveillance system shall monitor, and record data acquired from multiple onboard camera sources that shall be arranged to maximize the coverage of the vehicle and its operations.
- c). The onboard camera system shall have day and night capabilities with performance down to at least 0.1 lux and provide high quality color video.
- d). The system shall operate continuously off the low voltage power supply system and be backed up by car battery as a vital load.
- e). A minimum of four (4) interior cameras shall be placed throughout each car to facilitate recognition of passengers and/or luggage onboard the rail vehicle.
- f). One camera shall be mounted in each entrance area with wide angled coverage of the entrance areas, doorways, and stairways.
- g). No less than two cameras shall be mounted in the passenger seating area. Cameras mounted in the passenger seating area shall be facing in opposing directions with overlapping viewing zones to maximize coverage.
- h). Failure of a single camera shall not affect system functionality.
- i). The cameras shall have adjustable resolution of at least 1080p with frame rates adjustable up to thirty (30) frames per second to avoid latency and/or frame loss.
- j). The cameras shall provide the latest MPEG-4 video compression commercially available, H.264 or greater.
- k). Each camera shall deliver compressed video in real time to the data storage device. All video cameras provided shall have a proven history of reliable operation on rail vehicles.
- l). The surveillance system shall commence recording data when the car is powered on, and continue recording until the car is powered off, unless otherwise directed by the Conductor.
- m). All communications equipment shall meet the requirements in Section 14, Communications. See also Chapter 24.

Part V: Interior Structures

11.31 Stairways

a). General Requirements:

- i). One stairway shall be located in each car in the entrance area of the car (see Figure 11-48 on page 11-307).
- ii). The stairway framing, step treads, and risers shall be constructed of stainless steel.
- iii). Stairway side walls shall be made of similar materials as interior wall panels throughout the car.
- iv). As required, hinged access panel(s), secured closed with stainless steel fasteners, shall be provided to give access to car side door tracks/mechanisms for maintenance.
- v). The steps shall be a minimum of 33" wide and an approximate height of 7" max.
- vi). The stairway shall be well lit to provide an open environment and shall be enclosed on three sides.
- vii). All stairways shall comply to 49 CFR 38.117 and ADA 2010 standards.
- viii). Amtrak prefers a straight stairway as opposed to a wraparound stairway for safety reasons.

b). Stair Flooring

- i). Flooring material identical to that used in the entrance areas shall be used on the stair treads and upper stairway landing.
- ii). All steps shall have a visual demarcation of the stairway.
- iii). The nosing shall extend the full width of the step and contrast visually from the stair tread and riser covering by 70%, as demonstrated by the following formula:

$$\text{Contrast (\%)} = [(B1-B2)/B1] * 100$$

Where:

B1 = Light reflectance value of brighter area

B2 = Light reflectance value of darker area

- iv). All stairway flooring materials shall be adhered to the stairway structure using a waterproof, durable epoxy on vertical and horizontal surfaces.
- v). The flooring will be anti-skid.

- c). Stair Handrails
 - i). A handrail shall be attached to the surrounding wall to assist the passenger when ascending or descending the stairway.
 - (1) The handrail shall meet the requirements of 49 CFR 38.115.
 - (2) Each stairway shall be equipped with handrails on both sides with a minimum clear width of 32 in. between handrails.
 - (3) These shall attach with positive locking machine screws directly to car structure for strength.
- d). Stairway CMF
 - i). Please refer to the attached CMF document (Exhibit F-2) for exact color, material, and finishes desired in the stairway. Please also refer to Chapter 19.
- e). Stairway Lighting
 - i). Each step riser in the stairway shall have a full width white strip light to illuminate the step landing below.
 - ii). Lights shall be arranged to avoid glare onto a passenger's eyes as they ascend the stairway.
 - iii). There shall be indirect RGB wash lighting along the entire length of handrails mounted against wall panels.
 - iv). Any logos or features that are installed on the stairway walls shall have backlighting.
 - v). Backlit HPPL markings for the LLEPM system shall be installed along the sidewalls adjacent to each step landing.
 - vi). HPPL markings shall not be installed on the step landings unless otherwise approved by Amtrak.

11.32 Elevators - Interiors

- a). The descriptions below contain the interiors features in the elevator system.
- b). The elevator structure is described in Chapter 6.
- c). Please refer to Chapter 1 for information regarding quantity of this elevators desired across the trainset and suggested layouts.
- d). Access control shall be provided to limit access to crew and/or identified passengers as determined by Amtrak.
- e). Access control system shall be configurable (operation by all, operation only by Amtrak personnel, etc.) without need of special equipment or PTE interface.

- f). The Elevator shall be designed according to the current Federal requirements and ASME A18.1.
- g). Manual backup or override shall be available to operate all motorized equipment in the case of power loss or malfunction.
- h). Specific adaptations of design standard requirements to applications for rail service may be presented to Amtrak and will be reviewed on a case-by-case basis.
- i). Elevator Requirements
 - i). The Elevator shall be operational while the train is at rest and while in motion.
 - ii). The Elevator platform shall be a minimum clear width of 36 inches, and a minimum clear length of 60 inches.
- j). Door requirements
 - i). Elevator doors shall be automatic such that a passenger can operate lift without assistance.
 - ii). In the event the power system is remotely located all necessary manual overrides and associated controls will be located adjacent to the Elevator.
 - iii). All warning indications for the Elevator system and any diagnostics shall be transmitted to the vehicle monitoring system for display on the conductor's console of the associated car.
 - iv). The Elevator shall be designed for roll in and roll out operation such that the passenger does not have to reverse direction after reaching the desired floor if possible and if this does not limit passenger accommodation counts.
 - v). The Elevator shall be designed to lift 800 lbs (362.9 kg).
 - vi). The elevator design shall allow for operation at any time during service operation.
- k). Power Systems
 - i). Lift shall be powered by car 480VAC bus.
 - ii). Controls, indicators, and interlocks shall be powered by cars 72VDC bus.
 - iii). The Elevator power systems maybe located adjacent to the lift or remotely.
 - iv). Regardless of location the power systems for the elevator will be sound insulated to such that all interior noise requirements are maintained through all phases of operation.

- l). Internal Features
 - i). Elevators shall include glass doors made from safety glass so that crew members can easily ensure the elevator is not stuck or occupied.
 - ii). Emergency Call Button
 - (1) One waterproof Emergency Call Button shall interface with the Passenger Emergency Intercom (PEI) in the elevator.
 - (2) The Emergency Call Button shall be located to provide access for passengers of all heights and accommodate ADA reach requirements
 - (3) The Emergency Call buttons shall have illuminated and audible indications when actuated.
 - (4) Placement of the buttons is subject to approval during design review.
 - iii). The PEI in the elevator shall interface with the Emergency Call Button.
 - (1) The PEI and Emergency Call button arrangement, including the interfaces used between them, must maintain the same safety level and a standalone PEI.
 - (2) The PEI and Emergency Call Buttons must remain functional under any degraded mode condition.
 - (3) See Chapter 14 for additional details.
 - iv). Stainless steel handrails 34" from the floor shall be mounted on all walls of the elevator.
 - v). Handrails shall be recessed into the HPL if possible.
 - vi). The handrails, secured to module structure, shall be provided as a grab point for steadying passengers.
 - vii). Handrail or grab bar positioning will be subject to mockup testing and Amtrak approval.
 - viii). Grab bar shall meet the requirements in 49 CFR 38.115.
 - ix). A stainless-steel kick plate shall be used in the elevator.
 - x). The kick plate shall be 24" high and easily replaceable due to wear and damage.
 - xi). HPL wall panels shall be used above the stainless-steel kick plate.
 - xii). Lighting in the elevator shall match the ceiling lighting in the STR.
 - xiii). The controller shall report alerts and faults in the elevator to the car diagnostic system. See Chapter 24 for additional information.

- m). Emergency Operation
 - i). Emergency controls shall be located on the lower floor in a cabinet locked with an Amtrak standard coach key.
 - ii). The Elevator vendor shall provide an outline of planned emergency operational procedures during preliminary design phase which will be updated and developed with Amtrak throughout the subsequent reviews.
 - iii). Manual Override Access
 - (1) 1 hour disassembly of the entire elevator is required
 - (2) Quickly and safely get elevator to bottom floor manually in the event of failure
- n). Controls
 - i). The Elevator shall be capable of operation by passengers utilizing standard controls common to elevators.
 - ii). Elevator controls shall include keycard access controls such that doors will not open without proper access.
 - iii). Pressing the elevator call button without usage of keycard access shall cause a labeled indicator that key access is required.
 - iv). Indicators on the control panel shall indicate the floor the elevator carriage is currently located at.
 - v). Upper floor elevator runway shall be fully enclosed with interior body panel matched materials.
 - vi). Provisions to open runway enclosure walls on the upper level in an emergency shall be provided. Usage of emergency tools included on the car is permitted to open the walls.
- o). Diagnostics and Control
 - i). Elevators shall be outfitted with overweight sensing devices to mitigate the risk of overloading the lifting mechanisms and taking the device out of service.
 - ii). Overloading mechanisms shall be sized according to the maximum amount of available weight with a safety factor to offset overweight sensing.
 - iii). Elevators shall have a positioning system, either by motor encoder or proximity switches, that will allow the controller to recover from loss of power and manual mode operations.
 - iv). There shall be a small status panel hidden from passenger view adjacent to the elevator control panel.

- (1) The status panel shall have either a display or a row of health status LEDs for each interlock that is required to operate the elevator.
 - (2) Elevators shall communicate with the onboard CDU to communicate errors and faults for quick diagnosis with the onboard crew.
 - (3) The controller and status panel shall include at a minimum: the following interlock statuses: "upper doorway closed", "lower doorway closed", "weight sensor", "motor ok", "adjustment ok", "manual override", "manual cut-out".
- v). The elevator controller shall monitor motor current and report preventative maintenance alerts and faults to the car diagnostic system.
 - vi). The elevator controller shall record each failed attempts to operate the elevator lift and include a snapshot of all interlocking signals with each failed attempt.
 - vii). The data shall be available to maintenance for trend analysis and training.
- p). Refer to Chapter 29 for further information on accessible features for the elevator.

11.33 Bulkhead Walls

- a). General
 - i). Bulkhead walls at the end of each passenger seating area shall be constructed of melamine or HPL- faced aluminum panels for durability and to be pleasing to the passenger.
 - ii). Any fiberglass material shall be covered with a high gloss gel coat. All seams will be sealed, using appropriate sealing materials.
 - iii). Fasteners shall not protrude from the wall panels but countersunk to be flush with the wall panels.
 - iv). Bulkheads dividing the car shall be constructed for durability. All joints shall be sealed, using appropriate sealing materials.
 - v). Fasteners shall not extend from the wall panels but instead countersunk to be flush with the wall panels.
 - vi). The bulkhead shall meet the structural strength required in APTA PR-CS-S-006-98.
 - vii). Panels shall be machined smooth and free of sharp edges and burrs. Like panels shall be identical.
 - viii). Edges and corners shall have generous radii. Finished surfaces shall be decorative laminate, Schneller G20002T or high-pressure laminate.
 - ix). Amtrak shall reserve the right to choose material it deems appropriate for the application.

- x). Provision for textile wainscot panels or sections shall be included.
 - xi). Panels shall include stainless-steel kick panels equal in height to the sidewall heater grills.
 - xii). Kick panels shall wrap the edges of the passage/ aisle side edge of the panel.
 - xiii). Bulkheads shall be designed so that decorative surfaces can be changed at overhaul without damaging the substrate.
 - xiv). Alternate panel construction will be considered where appropriate.
 - xv). To keep the number of fasteners low, service panels shall be kept as small as possible while still allowing access to the necessary items requiring access.
 - xvi). The gaskets shall be protected from crushing through the use of metal-to-metal stops incorporated around the mounting fastener holes.
 - xvii). Please refer to Chapter 1 for information regarding quantity of bulkhead walls desired across the trainset.
 - xviii). Quantity will be determined by the Contractors proposed number of cars per trainset and suggested layouts.
 - xix). To the extent possible, the Contractor shall adhere to the general structure images for bulkhead walls as shown in Figure 11-49 and Figure 11-50.
 - xx). There shall be two types of bulkhead walls on the trainset: bulkheads that include doors and bulkheads without doors.
 - (1) Bulkheads with Doors
 - (a) For bulkheads at end door or partitions, bulkheads should have a flush integrated screen and provision for Amtrak 3D branding.
 - (b) Doors should be made from safety glass, have a minimal frame and an accessible touch button to open the door. (see Figure 11-49 on page 11-308)
 - (2) Bulkheads without Doors
 - (a) Lower floor bulkheads where there is no throughway should be graphically split below luggage shelf with a provision for a flush integrated screen and an area for the Amtrak 3D branding.(see Figure 11-50 on page 11-309)
- b). CMF
- i). Please refer to the attached CMF document (Exhibit F-2) for exact color, material, and finishes desired in bulkhead walls. Please also refer to Chapter 19.

11.34 Ceilings

- a). Ceiling panels shall be designed and constructed and installed to allow easy individual removal for maintenance and repair of any components included in the ceiling design, such as air ducts.
- b). Ceiling panels shall be constructed of material that meets flame, smoke, toxicity and structural standards, subject to Amtrak's approval.
- c). The ceilings shall be made of a wear resistant and easy to clean material, preferably coated metal sheets or HPL panels.
- d). Hallway and central ceiling panels shall be lightweight phenolic composite sandwich design or honeycomb construction.
- e). Panels shall have a dense phenolic composite edge machined smooth and free of sharp edges and burrs or may employ imbedded aluminum trim.
- f). Alternatively, as appropriate, formed aluminum panels may be used. Finished surfaces shall be decorative laminate, Schneller G20002T.
- g). Corners and edges shall be rounded.
- h). Panels should be self-trimming.
- i). Where trim extrusions are necessary between panels, their size should be minimized.
- j). The number of visible fasteners should be minimized.
- k). Piano hinged ceiling panels shall be designed, constructed, and installed to allow easy individual opening and closing to provide access for maintenance and repair of any components located above the ceiling, such as:
 - i). body end door operators and tracks,
 - ii). HVAC air ducts,
 - iii). lighting fixtures,
 - iv). PA speakers,
 - v). water piping,
 - vi). wiring, etc.
- l). These panels shall be hinged along one edge in such a way that they may be hung open or easily removed from the hinge.
- m). Ceiling panel size shall allow a single person to open/ close the panels safely, unaided.
- n). The panels shall be secured closed with Southco or equal draw-tight vice-action

latches with indicators for the locked position.

- o). The driver required for the latch will be determined during the design phase.
- p). Each panel shall include a passive self-engaging safety catch to prevent accidental panel openings.
- q). These safety devices shall be stainless steel and be configured so as not to rattle in service. The safety latch shall be self-engaging when closing the panel.
- r). Panels shall be sealed against air leaks around their entire perimeter, with the seal on the stationary side of the joint.
- s). Any components that penetrate the ceiling shall form an air-tight joint to the ceiling to avoid dirt streaking.
- t). The seal on these items shall be on the component, rather than the ceiling panel.
- u). The method of securing the ceiling panel to the car structure shall ensure that panels cannot drop at all due to any car motion from coupling/ uncoupling as well as under all operating conditions at all authorized speeds on any FRA class of track.
- v). Hinged panels, which provide access of overhead equipment such as door operators, water heater, galley exhaust hood blower, etc, shall be equipped with a limit switch so that when the panel is opened, the associated service lights shall be illuminated.
- w). Where the car ceiling panels form the bottom of the HVAC duct, they shall be hinged along one side to allow them to be easily opened for periodic duct cleaning.

11.35 Flooring

- a). Floor Covering
 - i). The car floor shall be equipped with a combination of carpeting and anti-slip flooring to provide an aesthetically pleasing and safe environment for the passenger.
 - ii). Safety and installation shall be foremost in the design.
 - iii). Carpeting is used not only for aesthetics, but also as a sound absorbent.
 - iv). All floor coverings shall be new.
 - v). The integration of the base floor material, carpeting, and shower/ restroom inserts shall be the subject of design review.
 - vi). Care shall be taken to ensure smooth transitions between flooring, carpeting, and transitions in doorways, restroom entrances, seat tracks, etc, to avoid tripping hazards.

- vii). Generally, clamping thresholds should be used at these joints and longitudinal carpet-retaining tracks used to secure carpeting.
- viii). Carpet- retaining track locations shall be coordinated with those of LLEPM tracks to ensure a smooth transition.
- ix). Joints in the floor beneath the floor covering shall be smooth with no transmit bumps, ridges, and other irregularities through to the finished surface of the covering.
- x). The builder shall provide an adhesive system suitable for railcar applications and be unaffected by the inherent flexing of vehicle interior color panels and temperature swings during train operation.
- xi). The adhesive shall not degrade the flammability, smoke emissions, and toxicity characteristics of the carpet, composite flooring, or car substrate.
- xii). The composite flooring, floor coverings, and their adhesive systems shall be able to withstand a wide variety of periodic and specialized stain removal cleaning typical for a passenger rail vehicle without any stretching, puckering, rippling, fraying, pulling up, or other adverse effect to the surface appearance or function.
- xiii). Cleaning may occur daily and at least every 90 days using a carpet cleaning machine, hot water, and caustic or acid chemicals.
- xiv). Daily specialized spot cleaning will take place using chemical cleaners, scrubbing with brushes, and application of gum remover.
- xv). The base floor and floor coverings shall be installed in accordance with the best practices of the industry and OEM instructions.
- xvi). Floor coverings, their trim, and the installation of these materials shall result in a smooth and flat floor covering for the life of the floor covering. Coverings shall be removable at end-of-life with no damage to the underlying floor panels.
- xvii). Floor covering seams should be kept to a minimum and the plan for seam location shall be approved by Amtrak during the design review process.
- xviii). The carpet vendor shall provide detailed recommended cleaning instructions for the builder to include in the maintenance manual sets.
- xix). To the extent possible, floor coverings for each site shall have the same dimensions among all cars, or among like cars at a minimum, so materials can be cut to size outside of the car and be installed with minimal on-car trimming.
- xx). Please refer to Figure 11-6 below and Exhibit F-2: *LD Color Material Finish (CMS) SHEETS, CMF Flooring Plan* for general outline of where each flooring type will be utilized:

Figure 11-6: Floor Covering Table

Location		Flooring Type
Standard Coach Seating Areas	Aisle	Anti-Slip Flooring
	Under Seats	High Traffic Carpet
	Entrance area	Anti-Slip Flooring
	Near Stairway	Anti-Slip Flooring
Premium Coach Seating Areas	Aisle	High Traffic Carpet
	Under Seats	High Traffic Carpet
	Near Stairway	Anti-Slip Flooring
	Near ATR	Anti-Slip Flooring
Cafe	Aisle	Anti-Slip Flooring
	Under Seats	Anti-Slip Flooring
	Around Café	Anti-Slip Flooring
	Near Stairway	Anti-Slip Flooring
Diner	Aisle	High Traffic Carpet
	Under Seats	Anti-Slip Flooring
	Near Servery	Anti-Slip Flooring
	Near Stairway	Anti-Slip Flooring
Lounge	Aisle	High Traffic Carpet
	Seating Area	High Traffic Carpet
	Near Bar	Anti-Slip Flooring
Sleeper Cabins	Aisle	High Traffic Carpet
	Inside Room	Low Traffic Carpet with cushioned backing
	Restrooms	Anti-Slip Flooring
Restrooms		Anti-Slip Flooring
Crew Rooms	Aisle	Anti-Slip Flooring
	Common Area	Anti-Slip Flooring
	Inside Room	Low Traffic Carpet with cushioned backing

b). Carpeting and Securement

i). Carpet

- (1) Heavy-duty commercial carpet shall be provided as indicated including seating areas and sleeper cabins.
- (2) Carpet shall be designed for modular replacement.

- (3) All areas of common design shall use template cut carpets. Linear carpets such as those used for aisles, shall likewise be of identical sizes within car types.
 - (4) Roomette and SoloSuite carpets shall be replaceable in 15 minutes each. Bedroom, Premium, and Accessible room carpets shall be replaceable in 20 minutes.
 - (5) Sleeping car and Dining car aisle carpets shall be replaceable in 30 minutes.
 - (6) All carpet shall be designed per Amtrak specification and shall be designed to provide maximum passenger comfort and safety as dictated by ergonomic requirements.
 - (7) The carpet shall be compliant with all applicable APTA and ADA guidelines.
- ii). Carpet Securement
- (1) Generally, the aisle and hall carpet shall be mechanically secured to the floor using longitudinal carpet-retaining tracks along both sides of the center aisle and along the outside edges of the car in the sleeper car hallway.
 - (2) A cove shall be provided where the carpet meets the longitudinal wall for ease of cleaning.
 - (3) Clamping thresholds shall be used at transitions to rubber or composite flooring and metal moldings, as required, such as at bulkheads.
 - (4) The carpet-retaining tracks along the aisle may be incorporated in the tracks for LLEPM.
 - (5) The spacing between the carpet-retaining tracks, moldings, etc shall be identical on all cars so that carpeting does not need to be trimmed to fit a specific car.
 - (6) If carpet must be glued into place at certain locations, these require Amtrak approval.
- c). Anti-Slip, Skid Resistant Flooring
- i). Skid-resistant, waterproof composite floor covering, that has been tested and proven to meet ADA requirements, shall be used where indicated including passageways, restrooms, food service areas and other utility areas where carpet is not installed.
 - ii). The floor design must comply with 36 CFR Part 1192 Appendix I. and RVAAC VI Floor Surfaces recommendations.

- iii). The floor covering shall have an integral cove, where specified, for easy cleaning, and shall extend from 2 in. to 10 in. up the wall, depending upon application.
- iv). The floor covering shall have an integral cove of 4 in. radius, where specified, for easy cleaning, and shall extend from 2 in. to 6 in. up the wall, depending upon application.
- v). Transition strips shall be provided between composite flooring and carpeted areas.
- vi). Transitions between flooring types shall produce level changes in flooring surfaces less than 0.25 in.
- vii). The trim strip between the wall lining and the floor covering shall be sealed to prevent harborage, accumulation of debris, or incursion of water and cleaning fluids.
- viii). Floors in entrance areas and end passageways shall have a 3 in. wide high-contrast visibility strip directly adjacent to door openings to delineate the door opening for visually impaired passengers.
- ix). The high-contrast strip at the side entry doors shall be made of high-performance photo-luminescent material so that it is integrated into the LLEPM system for exit pathway marking.
- x). The LLEPM material and application shall comply with APTA Standard PR-PS-S-004-99 and shall be embedded in the floor system.
- xi). All flooring shall be installed using an adhesive system that is approved by the flooring manufacturer and Amtrak.

11.36 Hallways

- a). General
 - i). Hallway information shall be used in any corridor or aisle through a train car with enclosed compartments on either side.
 - ii). All hallways shall be designed and constructed to form a safe and attractive environment. Visible fasteners shall be minimized.
 - iii). Modularity shall be optimized during the design process and the outer walls of the modules shall be developed as a common component where possible.
 - iv). All mounted items in the area shall be secured to the module structure through the use of fully embedded tapping plates when pullout strength or expected weight is greater than 20 lbs.
 - v). These are expected to last the life of the car without coming loose.
 - vi). Consistent features shall be maintained across hallways to the extent possible.

- vii). Please refer to Chapter 1 for information regarding quantity of hallways desired across the trainset. Quantity will be determined by the Contractors proposed number of cars per trainset and suggested layouts.
 - viii). To the extent possible, the Contractor shall adhere to the general arrangement images for hallway areas as shown in Figure 11-51.
- b). Requirements for integrated systems in all hallways are listed below.
- i). HVAC
 - (1) Supply Air Diffusers
 - (a) Conditioned air is delivered to the hallway via 2 supply air diffusers with adjustable air flow control and located on the windowsill of the outside window.
 - (2) Exhaust Grille
 - (a) Exhaust air is removed from the room via the exhaust air grille which is located at the upper portion of the module.
 - (3) Air Circulation Fans
 - (a) Air circulation fans with controls shall be provided at the head of each sleeping berth.
 - (b) The purpose is to stir car air and decrease the potential for temperature differential between upper and lower areas of the car.
 - (c) The air circulation fans shall have manual adjustment of the airflow direction.
 - ii). Communications
 - (1) Speaker
 - (a) PA speaker shall be located on the central ceiling panel.
 - (b) The PA speaker shall have an associated mute button.
 - (c) The speaker used in this location shall be identical to PA speakers used in other locations in the trainset for ease of maintenance and replacement.
 - (2) Passenger Emergency Intercom
 - (a) A PEI shall be located in every car in addition to specified locations called out later in this section.
 - (b) The intention of this button is to notify the conductor and flag the entire train that there is an onboard emergency.

- (3) All communications equipment shall meet the requirements in Chapter 14.
- iii). Electrical System
 - (1) Electrical equipment information is shared in detail for each hallway area.
 - (2) All electrical equipment in the entrance area shall meet the requirements in Chapter 15.
- iv). Lighting System
 - (1) Lighting general information is shared in detail for each area. Detailed lighting information can be found in Chapter 13.
 - (2) Note that all lighting part numbers, manufacturers, and temperatures shall be proposed by the Contractor and approved at Amtrak after the lighting simulation during the design review process.
- v). Emergency Equipment
 - (1) Chapter 18 details emergency equipment requirements. Generally, the following items shall be included.
 - (a) Smoke Detector
 - (i) Smoke Detectors shall be mounted on the central ceiling panel.
 - (ii) The smoke detector used in this location shall be identical to the smoke detectors used in other locations in the trainset for ease of maintenance and replacement.
- vi). CMF
 - (1) Please refer to the attached CMF document (Exhibit F-2) for exact color, material, and finishes desired in this sleeper cabin area. Please also refer to Chapter 19.
 - (a) Wall Panels
 - (i) Wall panels shall be wrapped in a protective film in accordance with Chapter 19 and the attached CMF document (Exhibit F-2). Paint is prohibited.
 - (ii) Sidewall Panels along the carshell wall shall be made from molded thermoplastic or melamine resin composite with an easy to clean surface finish.
 - (iii) Partition Walls shall be created from a composite structure such as aluminum honeycomb, melamine resin, or HPL skinned honeycomb panels.

- (iv) The finish of the wall and material of the outside skin shall be inspired by the CMF document (Exhibit F-2) and meet all structural requirements for crashworthiness based on mounting and attached loads to the panel.
 - (b) Ceilings
 - (i) Ceiling panels shall be wrapped in a protective film in accordance with Chapter 19 and the attached CMF document (Exhibit F-2). Paint is prohibited.
 - (ii) Ceiling shall be created from a composite structure such as aluminum honeycomb or HPL skinned honeycomb panels. Please refer to Section 11.34 for details on this ceiling type.
 - (iii) The finish of the passenger facing side of the ceiling panel and material of the outside skin shall be inspired by the CMF document (Exhibit F-2) and meet all structural requirements for crashworthiness based on mounting and attached loads to the panel.
 - (iv) The finish of the material on the non-passenger facing side shall be coated such that there is no risk of corrosion from moisture from steam or humidity within the car.
 - (c) Flooring
 - (i) Flooring within the hallway shall be made from high traffic carpet flooring.
- c). Key Features
 - i). A comprehensive list of expected features in hallways is provided in Figure 11-7 and described in detail below.
 - ii). In addition to these requirements, the Contractor shall factor in safety, crashworthiness, materials and workmanship, FDA cleaning clearances, radii, and sanitary design. All mechanisms described below should be durable, free from jamming, and racking. The design should meet abuse load and crash criteria. Dimensions, position, and usability will be subject to Amtrak approval during the mockup review.

Figure 11-7: Key Features - Hallways

Feature	Short Description	Qty
Handholds	49 CFR 238.115 compliant handrails	Depends on car type
Trash Bin	Trash bin with push flaps and access door	At least 2
Panel Work	HPL panels and Tedlar style sidewall liners	NA
Passenger Information Screens	Digital display monitor (PIS/OTIS)	2
Control Panel Doors	Access panels with seamless features to panel work	NA
Kick Strips	9" stainless steel strips	NA
Trim panels	Wall panel with provisions for mounting lighting, signage etc.	NA
Lighting Valance	Cover plate for accent lighting	NA

- iii). Handholds
 - (1) General
 - (a) Compliant handholds should be supplied.
 - (b) Grab bar positioning will be subject to mockup testing and Amtrak approval.
 - (c) Grab bars shall meet the requirements in 49 CFR 38.115.
 - (2) Horizontal Handrails
 - (a) Horizontal handrails shall be provided along the full length of a hallway along the window side of the aisle, if applicable.
 - (3) Vertical Grab Bars
 - (a) Vertical grab bars shall be provided between every cabin or compartment.
- iv). Trash Bin
 - (1) Trash bins shall be provided with stainless steel push flaps.
 - (2) Please refer to Section 11.17 for more information on trash and recycling requirements.
- v). Panel Work
 - (1) Hallways should be designed to have well fitted clean panels with a high tolerance build to manage split lines and cabinet edging.
 - (2) There should be no protruding equipment, snag point, or dirt traps.
 - (3) All equipment storage cabinets should be accessible using a crew key with discreet locks.
- vi). Passenger Information Screen (PIS/OTIS)
 - (1) Display screens should be supplied on both ends of the hallways.
- vii). Control Panel Door
 - (1) All equipment storage cabinets should be accessible using a crew key with discreet locks.
 - (2) These doors should use the same front panel as the other hallway wall paneling.
- viii). Kick Strip
 - (1) Stainless steel kick strips at 9" high should be used in all hallways.

- ix). Trim Panels
 - (1) Decorative trim panels with integrated wash-lighting should clad the staircase, providing a method of downlighting lower side wall panels.
 - (2) Allowance for an area on the panel should provide suitable space to apply wayfinding signage.
 - (3) Trim panels differ from panel work in that trim panels are locations for wayfinding and accent lighting features to be mounted.
- x). Lighting Valance
 - (1) Lighting valance shall be provided above the window line and shall run the length of side corridor.
- d). Additional Equipment Requirements
 - i). Wash Lights (RBG Lights)
 - (1) Wall Panel Wash Light
 - (a) Indirect strip lights wash light onto the ceiling from the top of the compartments along the hallway.
 - (2) Cove Lighting
 - (a) Cove lighting shall provide mood lighting to cast indirectly across ceiling above window line.
 - (3) Dado Lighting
 - (a) Wash downlighting shall be provided on the lower sides of the wall.
 - ii). LED Panel Spot Lights (White Lights)
 - (1) Small circular LED light panels shall act as spot lights along aisles.
 - (2) The frame for the spot lights shall be color matched to the ceiling.
 - iii). Compartment Light (RBG Lights)
 - (1) Handhold
 - (a) Integrated LED strips embedded into the back of handholds cast light backwards around handhold areas.
 - (b) Light should enhance contrast for visibility and safety.
 - iv). See Figure 11-52 on page 11-311.

11.37 Entrance Areas

a). General

- i). Entrances for the bilevel cars shall have entrance doors on both sides of the car.
- ii). Entrance areas shall include a 60" turning circle.
- iii). Entrance areas shall include a way for passengers to traverse to the second level via stairs, elevator, or both depending on car type.
- iv). All entrance areas shall be designed and constructed to form a safe and attractive environment.
- v). Visible fasteners shall be minimized.
- vi). Modularity shall be optimized during the design process and the outer walls of the modules shall be developed as a common component where possible.
- vii). All mounted items in the area shall be secured to the module structure through the use of fully embedded tapping plates when pullout strength or expected weight is greater than 20 lbs.
- viii). These are expected to last the life of the car without coming loose.
- ix). Consistent features shall be maintained across entrance areas to the extent possible.
- x). Please refer to Chapter 1 for information regarding quantity of entrance areas desired across the trainset. Quantity will be determined by the Contractors proposed number of cars per trainset and suggested layouts.
- xi). To the extent possible, the Contractor shall adhere to the general arrangement images for entrance area as shown in Figure 11-53 on page 11-312.

b). Integrated Systems

i). HVAC

(1) Supply Air Diffusers

- (a) Conditioned air is delivered to the entry area via 2 supply air diffusers with adjustable air flow control and located on the windowsill of the outside window.

(2) Exhaust Grille

- (a) Exhaust air is removed from the entry area via the exhaust air grille which is located at the upper portion of the module.

(3) Air Circulation Fans

- (a) Air circulation fans with controls shall be provided.
 - (b) The purpose is to stir air and decrease the potential for temperature differential between upper and lower areas.
 - (c) The air circulation fans shall have manual adjustment of the airflow direction.
- ii). Communications
 - (1) Speaker
 - (a) PA speaker shall be located on the central ceiling panel.
 - (b) The PA speaker shall have an associated mute button.
 - (c) The speaker used in this location shall be identical to PA speakers used in other locations in the trainset for ease of maintenance and replacement.
 - (2) Passenger Emergency Intercom
 - (a) A PEI shall be located in every car in addition to specified locations called out later in this section.
 - (b) The intention of this button is to notify the conductor and flag the entire train that there is an onboard emergency.
 - (3) All communications equipment shall meet the requirements in Chapter 14.
- iii). Electrical System
 - (1) All electrical equipment in the entrance area shall meet the requirements in Chapter 15.
 - (2) Junction Box
 - (a) The junction box shall be located where practical and shall be presented during the design phase. It shall be easily accessible by the maintenance group.
- iv). Lighting System
 - (1) Lighting general information is shared in detail for each area. Detailed lighting information can be found in Chapter 13.
 - (2) Note that all lighting part numbers, manufacturers, and temperatures shall be proposed by the Contractor and approved at Amtrak after the lighting simulation during the design review process.

- v). Emergency Equipment
 - (1) Chapter 25 details emergency equipment requirements.
 - (2) Smoke Detector
 - (a) Smoke Detectors shall be mounted on the central ceiling panel.
 - (b) The smoke detector used in this location shall be identical to the smoke detectors used in other locations in the trainset for ease of maintenance and replacement.
- c). Security
 - i). Many items within the entrance area will need to be secured.
 - ii). The following items are identified with specific locking preferences:
 - (1) Crew access panels
 - iii). Any other locking or security items will be discussed with Amtrak during design reviews.
- d). CMF
 - i). Please refer to the attached CMF document (Exhibit F-2) for exact color, material, and finishes desired in this entrance area. Please also refer to Chapter 19.
 - ii). Wall Panels
 - (1) Sidewall Panels along the carshell wall shall be made from molded thermoplastic or melamine resin composite with an easy to clean surface finish.
 - (2) Partition Walls shall be created from a composite structure such as aluminum honeycomb, melamine resin, or HPL skinned honeycomb panels.
 - (3) The finish of the wall and material of the outside skin shall be inspired by the CMF document (Exhibit F-2) and meet all structural requirements for crashworthiness based on mounting and attached loads to the panel.
 - iii). Ceilings
 - (1) Ceiling shall be created from a composite structure such as aluminum honeycomb or HPL skinned honeycomb panels.
 - (2) The finish of the passenger facing side of the ceiling panel and material of the outside skin shall be inspired by the CMF document (Exhibit F-2) and meet all structural requirements for crashworthiness based on mounting and attached loads to the panel.

- (3) The finish of the material on the non-passenger facing side shall be coated such that there is no risk of corrosion from moisture from steam or humidity within the car.
- iv). Flooring
 - (1) Flooring within the entrance area shall be made from high traffic anti-skid flooring. Please refer to Section 11.35 for details on this flooring type.
- e). Key Features
 - i). A comprehensive list of expected features in entrance areas is provided in Figure 11-8 and detailed below.
 - ii). In addition to these requirements, the Contractor shall factor in safety, crashworthiness, materials and workmanship, FDA cleaning clearances, radii, and sanitary design. All mechanisms described below should be durable, free from jamming, and racking. The design should meet abuse load and crash criteria. Dimensions, position, and usability will be subject to Amtrak approval during the mockup review.
 - iii). Handholds
 - (1) Compliant handholds should be supplied on both sides of each door, at key access point along aisles and on both sides of elevators.
 - (2) Grab bar positioning will be subject to mockup testing and Amtrak approval.
 - (3) Grab bar shall meet the requirements in 49 CFR 38.115. Handhold grab bars shall be made from stainless steel.
 - iv). Door Threshold
 - (1) Door threshold should have a slip-free surface and a contrasting floor color to the main entrance area flooring to mark the threshold.
 - v). Trash Bin
 - (1) Trash bins shall be provided with stainless steel push flaps.
 - (2) Please refer to Section 11.17 for more information on trash and recycling requirements.
 - vi). Panel Work
 - (1) Entrance areas should be designed to have well fitted clean panels with a high tolerance build to manage split lines and cabinet edging.
 - (2) There should be no protruding equipment, snag point, or dirt traps.

- (3) All equipment storage cabinets should be accessible using a crew key with discreet locks.
- vii). Hand Sanitizer Dispenser
 - (1) An infrared hand sanitizer dispenser shall be installed in each car in the entry vestibule on the lower level and in the end of car vestibule at both ends of the upper levels.
 - (2) The dispenser shall provide a touchless and hygienic solution for dispensing hand sanitizer in public places.
 - (3) Infrared Sensor
 - (a) The dispensers shall utilize advanced infrared sensor technology for touchless operation.
 - (b) The IR sensor shall have an adjustable sensor range to optimize detection distance.
 - (4) The dispenser shall accommodate a minimum of 1000 ml of hand sanitizer.
 - (a) The sanitizer reservoir shall be easily refillable without the use of tools.
 - (5) The dispensers shall be powered via hardwired connection.
 - (6) The dispensing volume shall be adjustable between 1.5 ml and 3.5 ml per application.
 - (7) The dispensers shall be constructed using durable and easy-to-clean materials suitable for high-traffic areas and compliant with all requirements of this specification.
 - (8) The dispenser shall have an LED indicator for low sanitizer levels.
 - (9) The dispensers shall be wall-mounted and shall allow for easy removal and replacement.
 - (10) Dispensers shall come filled with an unscented, hand sanitizer with a minimum alcohol content of 60%.
- viii). Passenger Information Screen (PIS/OTIS)
 - (1) Display screens should be supplied on both sides of the door.

Figure 11-8: Key Features - Entrance Areas

Feature	Short Description	Qty
Handholds	49 CFR 38.115 compliant handrails	4
Door Threshold	Anti-slip, color contrast, texturized flooring at door	2
Trash Bin	Trash bin with push flaps and access door	2
Panel Work	HPL panels and Tedlar style sidewall liners	NA
Passenger Information Screens	Digital display monitor (PIS/OTIS)	2
Control Panel Doors	Access panels with seamless features to panel work	NA
Tide Lines	Aluminum anodized colored trim for class indicator	NA
Kick Strips	9" stainless steel strips	NA
Trim panels	Wall panel with provisions for mounting lighting, signage etc	NA
Stairs	Steps connecting lower and upper level in bilevel train	1
Elevator	Accessible access for connecting lower and upper level in bilevel train	1
Storage for Step Ladder	Storage location for step ladder	1
Wheeled mobility device Lift	Wheeled mobility device lift for boarding (in designated cars)	1
Crew Door Control Panel	Exposed crew controls and buttons for doors and lifts	1
Electrical Control Panel	Maintenance storage location behind access panel	1
PEI	Emergency Alert system with intercom	1

- ix). Control Panel Door
 - (1) All equipment storage cabinets should be accessible using a crew key with discreet locks.
 - (2) These doors should use the same front panel as the other entrance area wall paneling.
- x). Tide Line
 - (1) There should be a horizontal tide line incorporated into the panel work.
 - (2) The colored edging between upper and lower panel acts as class identifier.
 - (3) The tideline shall be anodized aluminum.
- xi). Kick Strip
 - (1) Stainless steel kick strips at 9" high should be used in all entrance areas and up the stairway.
- xii). Trim Panels
 - (1) Decorative trim panels with integrated wash-lighting should clad the staircase, providing a method of downlighting lower side wall panels. Allowance for an area on the panel should provide suitable space to apply way-finding signage.
- xiii). Stairs
 - (1) Stairs shall comply with ADA standards for riser, tread, nosing and handrails.
 - (2) The rake of the stairs shall be maximized within these guidelines to limit the space taken up by the stairway.
 - (3) An additional lower handrail should also be included to assist children climbing the stairs, handrails should be free from snags.
 - (4) Please refer to Section 11.31 for detailed requirements for the stairway.
- xiv). Elevator
 - (1) Elevator should have full height sliding safety glass doors.
 - (2) The opening can be achieved with a two-leaf door.
 - (3) Elevator should be well lit and comply with ADA standards and all other requirements set out in the technical specification.
 - (4) Elevator call button should be provided in an accessible location.

- (5) Please refer to Section 11.32 for detailed requirements for the elevator.
- xv). Step Ladder and Storage
 - (1) A step ladder shall be provided which aids in passenger boarding when not at a level platform. The step ladder shall work at floor height at all platforms.
 - (2) A storage location shall be labeled and located behind an access panel with a paddle latch for a step ladder.
- xvi). Wheeled mobility device Lift
 - (1) Wheeled mobility device lifts shall be mounted on doors on both sides of the train, where indicated in Chapter 1 layouts.
 - (2) The wheeled mobility device lift mounting shall not impede on passenger ingress or egress through the doorway.
 - (3) Please refer to Chapter 12 for more information.
 - (4) Crew door controls shall be exposed for ease of access and located on a panel near the entry and exit doors of the train. Please refer to Chapter 12 for more information.
 - (5) Electrical control panels shall be located behind access panel doors that are operated using a square lock, or as otherwise approved by Amtrak.
- xvii). PEI
 - (1) Intercom and alert button shall be integrated into the sidewall for emergency notification and communication. Please refer to Chapter 14 for more information.
- f). Lighting
 - i). General
 - (1) Lighting general information is shared in the points below.
 - (2) Approximate lighting locations and types are shown in the following Figure:
 - (a) Figure 11-54: Entrance Area Light Locations (see page 11-313)
 - ii). Wash Lights (RGB Lights)
 - (1) Ceiling Pool Light
 - (a) Ring pool lighting in the ceiling provides indirect mood wash light in the center of the entrance area.

- (b) Locations and sizes will be subject to review, user testing, and Amtrak approval.
- (2) Wall Panel Wash Light
 - (a) Indirect strip lights wash light onto the ceiling from the top of the entrance area monuments.
 - (b) Lights will act as way finding by displaying class identifiers color during boarding sequences.
- iii). LED Panel Spot Lights (White Lights)
 - (1) Small circular LED light panels shall act as spot lights above the doors, elevators, and along aisles.
 - (2) The frame for the spot lights shall be color matched to the ceiling.
- iv). Compartment Light (RGB Lights)
 - (1) Handhold Lights
 - (a) Integrated LED strips embedded into the back of handholds cast light backwards around handhold areas.
 - (b) Wash-light on each side of the door should pulse to signify when the door is opening.
 - (c) Light should enhance contrast for visibility and safety.
 - (2) Step Lights
 - (a) Step lights should illuminate interior threshold during boarding sequences.

Part VI: Coach Areas

11.38 Interior Structures - Coach Specific

- a). General
 - i). The coach areas consist of two different service levels: standard coach and premium coach.
 - ii). To the extent possible, the Contractor shall adhere to the general arrangement images for coach area as shown in Figure 11-55 on page 11-314.
- b). Key Features
 - i). A comprehensive list of expected features of the Coach Interior structures is provided in Figure 11-9 and described in detail below.
 - ii). General
 - (1) The Contractor shall factor in safety, crashworthiness, materials and workmanship, FDA cleaning clearances, radii, and sanitary design.
 - (2) All mechanisms described below should be durable, free from jamming, and racking.
 - (3) The design should meet abuse, load, and crash criteria outlined in CFR.
 - (4) Dimensions, position, and usability will be subject to Amtrak approval during the mockup review.
 - iii). Skylight Windows
 - (1) Options for skylight windows shall be included for all cars except the end coach and the utility cars.
 - (2) Please refer to Chapters 6 and 19 for more information regarding window requirements.

Figure 11-9: Key Features - Coach Interior Structures

Feature	Short Description	Qty
Skylight Windows	Flat windows located at angle on ceiling	Option to be exercised by Amtrak, Qty determined by Contractor
Skylight Blinds	Blinds that cover skylight windows	2 per skylight window
Skylight Valance	Cover plate for lighting and seating reservation screens	1 per window
Windows	Windows in the side wall of the car	Qty determined by Contractor
Blinds	Blinds that cover windows	2 per window
Window Pillars	Structural member between windows	NA
Window Masks	Cover for window installation	NA
HVAC Gondola	HVAC air path through the center of the car	NA
Side Ceiling Panels	Lateral side ceiling panels along the curve from sidewall to ceiling panel	NA
Kick Strips	9" stainless steel strips	NA
Side Rails	Decorative strip under windows to conceal lighting	NA
Lower Sidewall Panels	HPL panels and Tedlar style sidewall liners	NA
Coat Hooks	Coat hooks that hold up to 25lbs	2 per seat row
Luggage Shelf	Overhead luggage rack	NA
Reservation Screen	Passenger information screen for each seat assignment	1 per seat row

iv). Skylight Blinds

- (1) Option for Skylight blinds to be automatic with a crew control switch per car shall be provided.
- (2) Blinds shall be stored in a valance or behind the luggage shelf so that they can easily be accessed for maintenance.
- (3) Blinds should cover the entirety of the window.
- (4) Blinds shall be replaceable within a 30 min timespan.
- (5) Please refer to Section 11.15 for more information regarding window blind requirements.

v). Skylight Valance

- (1) If skylight option is exercised, seat reservation system would be integrated with the skylight valance.
- (2) Design should allow for a luggage shelf to be installed.

vi). Window

- (1) Please refer to Chapters 6 and 19 for more information regarding window requirements.

vii). Window Blinds

- (1) Blinds shall be stored in a valance or behind the luggage shelf so that they can easily be accessed for maintenance.
- (2) Blinds should cover the entirety of the window.
- (3) Lower blind handle should be easy to use and accessible with no racking or jamming.
- (4) Blinds shall be replaceable within a 30 min timespan.
- (5) Please refer to Section 11.15 for more information regarding window requirements.

viii). Window Pillar

- (1) Window pillar width should be minimized.
- (2) In the case of a car with skylights the pillar trim should continue over the side ceiling to create an arched aesthetic.

ix). Window Mask

- (1) Window mask should minimize or mask glass corners to create an architectural aesthetic.

- x). HVAC Gondola
 - (1) Gondola shall be designed to maximize headroom and be suitable to accommodate skylight options.
 - (2) Lighting washes both centrally into gondola and across side ceilings shall be provided.
 - (3) The gondola should terminate and transition to a separate lower ceiling section if any equipment or junction in the interior architecture prevents the gondola from completing a full uninterrupted run.
 - (a) For example - where the ceiling moves around an elevator or ATR.
 - (4) At these junctions the gondola should terminate in a straight line with architecture that creates a visual ring at the termination point.
 - (5) The transition between ceiling profiles should be treated with clean and well considered intersections.
 - (6) These lower ceilings should have their own lighting light wells and HVAC vents.
- xi). Side Ceiling Panels
 - (1) Side ceilings should be washed with light from central gondola.
 - (2) These side ceiling panels shall be curved to create a smooth transition from the ceiling to the back of the overhead luggage racks.
- xii). Kick Strips
 - (1) Stainless steel kick strips at 9" high should be used in all coach areas.
- xiii). Side Rails
 - (1) Side rails under each window shall include a tideline with integrated lighting to wash lower side wall panel.
- xiv). Lower Sidewall Panels
 - (1) Lower side wall panels shall be provided such that the trim panel has minimized thickness to take advantage of full width of the car body.
 - (2) These should be designed to have well fitted clean panels with a high tolerance build to manage split lines and cabinet edging.
 - (3) There should be no protruding equipment, snag point, or dirt traps.
- xv). Coat Hooks

- (1) Coat hooks should be provided for each seated location, integrated with the luggage shelf and skylight valance.
- (2) Hooks should be easy to move if seat positions or set pitch is changed in the future.
- (3) A solution where integrated coat hooks are provided in the back of the seat will also be considered and is subject to Amtrak approval during the design review process.

xvi). Luggage Shelf

- (1) Overhead Luggage Shelf shall meet the requirements of:
 - (a) Section 11.22: Luggage Storage - General
 - (b) Section 11.23: Overhead Luggage Storage
- (2) The overhead luggage shelf should be built in modules that align with window placements.
- (3) Split lines and module length should be consistent and to visually match the window module splits.
- (4) The overhead luggage shelf shall be modular to create different length segments using extruded aluminum.
- (5) The following elements shall be included:
 - (a) Back Barrier – Back of rack should prevent bags from damaging side ceiling panels.
 - (b) Rollstop Nosing – Nosing of luggage shelf should be suitable to secure bags.
 - (c) Glass Panel – Glass panel construction from safety glass to allow passengers to see bag and let light through - frosted finish or laminated with decorative film or etching pattern.
 - (d) Module Dividers – Divider brackets to prevent bag slip - discreet design with no sharps, snags, or dirt traps.
 - (e) Blind Storage – Blind storage should be easily accessible and discreetly hidden behind rack.
 - (f) Rack Lighting – Rack lighting shall be mounted to the underside of the luggage shelf and light washes down across window pillars, blind surfaces.

xvii). Reservation Screen

- (1) Passenger information displays should be integrated with the rack design.

- (2) The position of the seat reservation module should be designed so they can easily be moved in case seat pitch or density is modified in the future.
 - (3) Reservation Screens shall meet the requirements of Section 11.29: Seat Reservation.
- c). Additional Equipment Requirements
- i). Lighting general information is shared in the points below and illustrated in Figure 11-56 on page 11-315.
 - (1) Wash Lights (RGB Lights)
 - (a) Ceiling Panel Wash light
 - (i) Indirect strip lights wash light onto the ceiling from the central gondola fixture inward.
 - (b) Gondola Ceiling Lighting
 - (i) Gondola Ceiling Lighting shall wash light from the gondola across the side ceiling panels
 - (c) Dado Lighting
 - (i) Wash downlighting shall be provided on the lower sides of the wall.
 - (d) Under Luggage Rack
 - (i) Indirect wash lighting hidden behind the rack shall wash down the side walls.
 - (e) Moon Pool Lights
 - (i) Moon Pool Lights shall be located when there are no gondolas in the ceilings. These shall provide indirect lighting pools from the curve across the ceiling.
 - (2) LED Panel Spot Lights (White Lights)
 - (a) Small circular LED light panels shall act as spot lights along aisles.
 - (b) The frame for the spot lights shall be color matched to the ceiling.
 - (3) Compartment Lighting (RGB Lights)
 - (a) Under seat lighting - Indirect wash lighting under each seat or seat pair washes pools of light under and around seat.

- (b) Spread of light to be approved by Amtrak.

11.39 Seats - General

- a). General Seat Ergonomics

- i). Through the use of the CAESAR Database for Anthropometric Data, seat frame, cushion, and arm rests shall be designed and optimized to accommodate all passenger sizes from the 5th percentile female through the 95th percentile male in a full range of normal seating positions.
- ii). A human factor specialist shall be involved in all stages of the design, testing, and review process.
 - (1) A coach seat should provide initial comfort when first seated and then comfort over the length of passenger travel (minimum of 2 hours and maximum of 72 hours)
 - (2) It should comfortably accommodate a variety of seating postures and provide comfort when seated posture changes.
 - (3) Back and seat cushions shall both be custom contoured through pressure mapping analysis to minimize contact pressures through the widest possible range.
 - (4) Lumbar support shall accommodate all passenger profiles.
 - (5) Premium Coach class seat shall provide enough width that two seated, co-located 95th percentile males will not contact elbows or shoulders.
 - (6) Sufficient knee space to allow for multiple seated positions for a 95th percentile male with no contact against the next seat backrest.
 - (7) Test rigs shall be utilized to evaluate both the initial design properties and longevity of materials, including but not limited to deflection, stiffness, thickness, material wear, and appearance.
 - (8) Deflection, stiffness, and thickness properties shall not decrease by more than 20% over the entire life of the cushion.
 - (9) Wear and appearance deterioration shall be minimized to accommodate an 8-year design life. Further detail is provided in Chapter 18.

11.40 Standard Coach Seats

- a). General

- i). The standard coach seat is designed to work as pairs with four seats across the width of the train.
- ii). The seat should be optimized for both day and nighttime operations.

- iii). Features are included that aid a better night's sleep or support passengers on longer journeys by maximizing comfort and available passenger space.
 - iv). The minimum width of the seat between armrests should be 19.5" when arranged with a minimum aisle dimension of 22".
 - v). All seats must have a movable armrest.
 - vi). Braille and raised characters shall be posted at the seat's headrest edge.
 - vii). A single seat type may be required in smaller numbers to accommodate transfer seats, maximize capacity and fulfil requirements around accessible paths in the accessible coach car.
 - viii). Contractor is responsible for meeting all technical requirements for all seat types, including any potential single seat designs.
 - ix). All seat types are expected to be included in the mockups.
 - x). Please refer to Chapter 1 for information regarding quantity of this accommodation type desired across the trainset and suggested layouts.
- b). Material
- i). Amtrak expects the following items to have a synthetic leather surface unless otherwise approved during design review process:
 - (1) Calf rest,
 - (2) seat pan,
 - (3) seat cushion,
 - (4) head rest,
 - (5) arm rests
 - ii). Amtrak expects the following items to have a metal brushed finish unless otherwise approved during design review process:
 - (1) Control buttons,
 - (2) hand grabs,
 - (3) reading light,
 - (4) structure,
 - (5) pedestal

c). Attachment

- i). Passenger revenue seats must meet the performance requirements as defined in APTA Standard PR-CS-S-016-99, Standard for Passenger Seats in Passenger Rail Cars.
- ii). This APTA Standard shall also be used as a design guideline.
- iii). Seats shall be designed to provide maximum passenger comfort and safety.
- iv). The seats shall be mounted in standard adjustable seat-mounting track allowing for pedestal or pedestal wall mounting.
- v). Mounting slots shall be included on the underside of the seat frame allowing for lateral adjustability so that the aisleway centerline and dimensions are consistent throughout the car with no misalignment or staggering.
- vi). The seat attachment angle to the car floor shall optimize passenger knee room.
- vii). HPPL signage shall be located either on the seat pedestal or seat frame.
- viii). HPPL charging shall be accomplished by local backlighting and not dependent on other interior light fixtures.
- ix). See Chapter 13 for additional details. HPPL shall not be placed on the floor.
- x). Approved tamper-resistant means of connections to a subfloor cable duct for electrical supply and future audio/visual data lines shall be provided.
 - (1) These connections shall provide for ease of future changes in seat spacing.
- xi). A provision for restraining two child retention seats per car as detailed by Amtrak during design review shall be provided.
- xii). Revenue seats shall be mounted in seat tracks on the floor and/or wall in all car types.
- xiii). Seat tracks shall be installed with Amtrak approval for all processes and drawings.
- xiv). Between seats, the wall and floor seat tracks shall be covered with a trim suitable for the application and as flush to the floor or wall panel as practical.
 - (1) Alternative floor and wall seat track installation locations shall be allowed as approved by the Customer.
- xv). Seats shall be mounted to the seat tracks in accordance with the strength and crashworthiness requirements of 49 CFR Section 238.233 (a) and APTA standard PR-CS-S-016-99.

Figure 11-10: Key Features - Standard Coach Seats

Feature	Short Description	Qty
Headrest Pillow	Adjustable portion of seat headrest	1
Privacy Wing	Protrusion on headrest to provide privacy	2
Hand Grab	49 CFR 38.115 compliant handrails	1
Reading Light	White light with adjustable lens and toggle switch	1
Seat Recline Mechanism	Sliding mechanism that attaches seat back to seat pan for recline	1
Calf Rest Pad	Cushioned pad for leg support	1
Seat Controls	Manual buttons that adjust seat configuration features	1
Folding Armrests	Arm rests that rotate upwards when stored	2
Flexible Net Pocket	Pocket at the base of the back of a seat for storage	1
On Seat Power	Outlets and USB integrated into the seat	2
Central Foot Pedestal	Support structure for a seat or pair of seats	1
Storage Strap	Small elastic band for retaining items	1
Fold Out Table	Table stored in the back of a seat	1
Cup Holders	Metal cup holder ring that folds flush with seatback	1
Device Holder	Small ledge for propping up a cell phone	1
Fold Out Footrest	Foot rest that is stored in the back of a seat	1

a). Key Features

- i). A comprehensive list of expected features in this type of coach seat is provided in Figure 11-10 and detailed below.
- ii). In addition to these requirements, the Contractor shall factor in safety, crashworthiness, materials and workmanship, FDA cleaning clearances, radii, and sanitary design.
- iii). All mechanisms described below should be durable, free from jamming, and racking.
- iv). The design should meet abuse load and crash criteria.
- v). Dimensions, position, and usability will be subject to Amtrak approval during the mockup review.
- vi). Seat Dimensions
 - (1) The following seat dimensions should be used as the basis for designing the seat (see Figure 11-57 on page 11-316).
 - (2) Note that seat dimensions are subject to Amtrak approval during the design review and mock up review processes.
 - (a) Seat width- at least 19.5"
 - (b) Seat depth- at least 17"
 - (c) Highest point on seat pan (at knee bend)- 18-19" from the ground
 - (d) Natural seat recline angle when in upright position- 105 degrees as measured from passenger facing side of seatback to passenger facing side of seat cushion (see Figure 11-58 on page 11-317)
 - (e) Seat pan recline- 5-7 degrees as measured from parallel to the floor.
- vii). Headrest Pillow
 - (1) Headrest pillow should be adjustable in height to comfortably accommodate the range from 5th percentile female to 95th percentile male seated heights.
 - (2) It should have adjustable wings that fold outwards to adjust the width of the headrest while also providing lateral support for the head when the passenger is resting or sleeping in an upright seated position.

viii). Privacy Wing

- (1) Privacy wing on the seats should provide good separation between passengers at head level and be wide enough and high enough as not to impact shoulder width for taller passengers.

ix). Hand Grab

- (1) Every aisle seat should have a compliant accessible grab for better access along the aisle.
- (2) Grab bar positioning will be subject to mockup testing and Amtrak approval.
- (3) Grab bar shall meet the requirements in 49 CFR 38.115.
- (4) With rotating seats hand grabs will need to be located on both sides of the seat.

x). Reading Light

- (1) Seats should include a reading light that is positioned so as not to disturb neighbor during nighttime hours.
- (2) Passengers should be able to adjust the lighting angle to cast light over the shoulder and into the lap or at a position suitable to read a book at night.
- (3) Light intensity should have three settings.

xi). Seat Recline Mechanism

- (1) Seat recline mechanism should allow the seat pan to slide forwards so as not to burden the full recline onto the passenger behind in addition to reclining the seat back.
- (2) It should be easy to use by people of all abilities and shall not require more than 3 lbf to adjust or operate.
- (3) The mechanism should be durable and rattle free. It should be free from finger traps.

xii). Calf Rest Pad

- (1) Calf-rests tilt up for optimal leg support and comfort. Angle and width to be optimized as part of a detailed human factors study.
- (2) The calf rest should be integral to the seat pan to avoid seat pinch.

xiii). Seat Controls

- (1) Seat controls for recline and leg rest should be located within easy reach of a customer - for example on the inner side of the outside armrests.
 - (2) It should be possible to control the seat back recline and the calf rest independently.
 - (3) The seat controls should be intuitive to use by people of abilities and shall require 3 lbf or less to operate.
- xiv). Folding Armrests
- (1) 2" wide armrest shall include a soft wrap around the top for comfort and a hard-wearing bottom wrap and side cap for durability.
 - (2) Armrests should be included on both sides of the seat and in between a seat pair.
 - (3) Armrest should fold flush or sub flush to the front surface of the seat back.
- xv). Flexible Net Pocket
- (1) A storage pocket should be provided on the back of the seat.
 - (2) A semi-rigid frame with a net suitable for passengers to stow personal items or for Amtrak literature.
 - (3) The net should be durable and allow a clear view of the items placed inside to aid quick and easy cleaning routines.
 - (4) The design should allow for this element to be quickly and easily replaced on the train.
- xvi). On-Seat Power
- (1) Two USB ports should be provided on the back of each of the seats.
 - (2) Two duplex plug sockets should be located on the seat pedestal. Sockets should be shielded from spills from the table or cup holder.
- xvii). Central Foot Pedestal
- (1) A central seat pedestal should be positioned to maximize foot clearance.
 - (2) Interface with the floor should allow easy cleaning.
- xviii). Storage Strap
- (1) Behind the fold down table a ledge and elastic restraint band suitable to allow customers to simply store smart phones and other personal items behind table.

- (2) The band should be durable and easily replaceable.

xix). Fold Out Table

- (1) A fold out table should be provided on each seat back.
- (2) The table shall have an independent pivot point so that its resting position will not be impacted by the recline of the seat in front.
- (3) The latch design should prevent accidental activation and the table should be free from rattle when either stored or fully deployed.
- (4) The table should be able to extend forwards telescopically.
- (5) The usable surface should allow people to use a 15" laptop -even when the seat in front of the passenger is fully reclined.
- (6) The mechanism should be durable and rattle free.
- (7) It should not extend accidentally.
- (8) When the table is deployed it shall be able to support a 50lbf point load on the end of the table without damage.

xx). Cup Holders

- (1) A metal cup holder should be positioned on the back of the seat.
- (2) Cup holders should be placed in positions outside of knee and leg clearance and free from the movement of the seat.
- (3) The cupholder should be an open clasp design capable of storing and securing cups of various diameters.
- (4) It should be designed to prevent passing passengers getting snagged.

xxi). Device Holder

- (1) A fold out ledge with clip should allow the secure mounting of passengers' personal devices.
- (2) The clip should be sprung and adjustable so different sizes can be securely kept in place including a typical tablet and/or a smart phone.
- (3) The angle should be set so it is usable in both recline and upright positions.
- (4) The latch should be designed in such a way to prevent accidental activation.

xxii). Fold out Footrest

- (1) A fold out adjustable footrest should be provided.

- (2) There should be three set positions and the footrest should have a degree of angle adjustment.
 - (3) The size and positions should be defined by a detailed human factors study.
- b). Functional Elements
- i). Seat Recline of 20 degrees
 - (1) Recline features
 - (a) When seats are fully reclined there shall be at least 7" of knee clearance for a 95th percentile male between the back of the seat in front of the passenger and his knees.
 - (b) The recline features shall be operated manually:
 - (i) The seatback shall recline
 - (ii) The seatpan shall slide forward
 - (iii) The calf rest shall extend forward to raise the legs
 - (iv) The footrest shall be able to be folded out
 - (c) As an option, a motorized and power assisted option for items 1-3 (above) shall be available for Amtrak to exercise upon request.
 - (i) If motorized and power assisted options are exercised, the seat shall be capable of adjustment manually in the event of power loss or malfunction.
 - (2) Seat Rotation
 - (a) The seats shall be installed all facing the same direction the right side of the aisle and on the left side of the aisle the seats shall be installed facing the opposite direction.
 - (b) As an option, Amtrak shall be able to elect to have rotation features for each of the seats in standard coach.
 - (c) If exercised, the seats shall all be installed facing the same direction on both sides of the aisle.
 - (i) Seats should have the capability to rotate at the end of the line so that all seats are facing the opposite direction.
 - (ii) This rotation would be manually performed by Amtrak staff.
 - (iii) Each seat bench should be able to be rotated in less than 1 min and shall lock in place.

- (iv) A visual indicator of the seat being properly secured shall be provided.
 - (d) As an alternate option, Amtrak shall be able to elect to have motorized rotation features for each of the seats in standard coach.
 - (e) If exercised, the seats shall all be installed facing the same direction on both sides of the aisle.
 - (i) Seats should have the capability to rotate at the end of the line so that all seats are facing the opposite direction.
 - (ii) This rotation would be performed by Amtrak staff at the push of a button and the rotation and locking shall be power assisted.
 - 1. If motorized and power assisted options are exercised, the seat shall be capable of adjustment manually in the event of power loss or malfunction.
 - (iii) Each seat bench should be able to be rotated in less than 1 min and shall lock in place.
 - (iv) A visual indicator of the seat being properly secured shall be provided.
 - (v) Any seat not fully locked into place shall send an alert to the conductor for inspection.
 - (vi) The controller shall report alerts and faults to the car diagnostic system. See Chapter 24 for additional information.
- c). Additional Equipment Requirements
 - i). Emergency Equipment
 - (1) Seats shall not obstruct emergency windows and, to the extent possible, shall be arranged to optimize passenger access to window views.
- d). CMF
 - i). Please refer to the attached CMF document (Exhibit F-2) for exact color, material, and finishes desired in this sleeper cabin area. Please also refer to Chapter 19.
 - ii). All colors, cushions, fabrics, and appearance shall be as directed by Amtrak. All revenue passenger seats shall share the same common design appearance.
 - iii). Individual components shall be interchangeable wherever possible.

- iv). They shall have a profile that is free of sharp corners and edges.
- v). All seat coverings shall use synthetic leather.
- vi). Arm rests, if upholstered, shall use the same covering as the seats.
- vii). Final construction of the cushions including sewing and fire blocking shall be subject to the approval of Amtrak.

11.41 Premium Coach Seats

a). General

- i). The Premium Coach seat is designed as an enhanced coach product. The seat shall be arranged 2x1 across a 32" accessible aisle.
- ii). The seat should be optimized for both day and nighttime operations.
- iii). Features are included that aid a better night's sleep or support passengers on longer journeys by maximizing comfort and available passenger space.
- iv). The minimum width of the seat between armrests should be 22" when arranged with a 32" aisle.
- v). A single seat option may also be required in smaller numbers to accommodate transfer seats and fulfil requirements around accessible paths in the accessible coach car.
- vi). Please refer to Chapter 1 for information regarding quantity of this accommodation type desired across the trainset and suggested layouts.

b). Material

- i). Amtrak expects the following items to have a synthetic leather surface unless otherwise approved during design review process:
 - (1) Calf rest,
 - (2) seat pan,
 - (3) seat cushion,
 - (4) head rest,
 - (5) arm rests
- ii). Amtrak expects the following items to have a metal brushed finish unless otherwise approved during design review process:
 - (1) Control buttons,
 - (2) hand grabs,
 - (3) reading light,

- (4) structure,
 - (5) pedestal
- c). Attachment
- i). Passenger revenue seats must meet the performance requirements as defined in APTA Standard PR-CS-S-016-99, Standard for Passenger Seats in Passenger Rail Cars.
 - ii). This APTA Standard shall also be used as a design guideline.
 - iii). Seats shall be designed to provide maximum passenger comfort and safety.
 - iv). The seats shall be mounted in standard adjustable seat-mounting track allowing for pedestal or pedestal wall mounting.
 - v). Mounting slots shall be included on the underside of the seat frame allowing for lateral adjustability so that the aisleway centerline and dimensions are consistent throughout the car with no misalignment or staggering.
 - vi). The seat attachment angle to the car floor shall optimize passenger knee room.
 - vii). HPPL signage shall be located either on the seat pedestal or seat frame.
 - viii). HPPL charging shall be accomplished by local backlighting and not dependent on other interior light fixtures. See Chapter 13. HPPL shall not be placed on the floor.
 - ix). Approved tamper-resistant means of connections to a subfloor cable duct for electrical supply and future audio/visual data lines shall be provided.
 - (1) These connections shall provide for ease of future changes in seat spacing.
 - x). A provision for restraining two child retention seats per car as detailed by Amtrak during design review shall be provided.
 - xi). Revenue seats shall be mounted in seat tracks on the floor and/or wall in all car types.
 - xii). Seat tracks shall be installed with Amtrak approval for all processes and drawings.
 - xiii). Between seats, the wall and floor seat tracks shall be covered with a trim suitable for the application and as flush to the floor or wall panel as practical.
 - (1) Alternative floor and wall seat track installation locations shall be allowed as approved by the Customer.

- xiv). Seats shall be mounted to the seat tracks in accordance with the strength and crashworthiness requirements of 49 CFR Section 238.233 (a) and APTA standard PR-CS-S-016-99.

d). Key Features

- i). A comprehensive list of expected features of the premium coach seats is provided in Figure 11-11 and detailed below.
- ii). Detailed functional requirements for each feature is listed below.
- iii). In addition to these requirements, the Contractor shall factor in safety, crashworthiness, materials and workmanship, FDA cleaning clearances, radii, and sanitary design.
- iv). All mechanisms described below should be durable, free from jamming, and racking. The design should meet abuse load and crash criteria.
- v). Dimensions, position, and usability will be subject to Amtrak approval during the mockup review.
- vi). Seat Dimensions

- (1) The following seat dimensions should be used as the basis for designing the seat (see Figure 11-59 on page 11-318).
 - (a) Seat Width: at least 22"
 - (b) Seat Depth: at least 20"
 - (c) Highest Point on Seat Pan (at knee bend): 19" from the ground
 - (d) Natural Seat Recline Angle when In Upright Position: 105 degrees as measured from passenger facing side of seatback to passenger facing side of seat cushion
 - (e) Seat Pan Recline: 5-7 degrees in full upright position as measured from parallel to the floor.

- (2) Seat dimensions are subject to Amtrak approval during the design review and mock-up review processes.

vii). Headrest Pillow

- (1) Headrest pillow should be adjustable in height to comfortably accommodate the range from 5th percentile female to 95th percentile male seated heights.
- (2) It should have adjustable wings that fold outwards to adjust the width of the headrest while also providing lateral support for the head when the passenger is resting or sleeping in an upright seated position.

Figure 11-11: Key Features - Premium Coach Seat

Feature	Short Description	Qty
Headrest Pillow	Adjustable portion of seat headrest	1
Privacy Wing	Protrusion on headrest to provide privacy	2
Hand Grab	49 CFR 38.115 compliant handrails	1
Reading Light	White light with adjustable lens and toggle switch	1
Seat Recline Mechanism	Sliding mechanism that attaches seat back to seat pan for recline	1
Calf Rest Pad	Cushioned pad for leg support	1
Seat Controls	Manual buttons that adjust seat configuration features	1
Sliding Armrests	Arm rests that slide beneath the seat pan when stored	2
Flexible Net Pocket	Pocket at the base of the back of a seat for storage	1
On Seat Power	Outlets and USB integrated into the seat	2
Central Foot Pedestal	Support structure for a seat or pair of seats	1
Fold Out Table	Bifold table attached to seat armrest	1
Cup Holders	Metal cup holder ring that folds flush with seatback	1
Device Holder	Small ledge for propping up a cell phone	1
Fold Out Footrest	Footrest attached to calf rest pad that can be telescopically extended	1

viii). Privacy Wing

- (1) Privacy wing on the seats should provide good separation between passengers at head level and be wide enough and high enough as not to impact shoulder width for taller passengers.

ix). Hand Grab

- (1) Every aisle seat should have a compliant accessible grab for better access along the aisle.
- (2) Grab bar positioning will be subject to mockup testing and Amtrak approval. Grab bar shall meet the requirements in 49 CFR 38.115.
- (3) With rotating seats hand grabs will need to be located on both sides of the seat.

x). Reading Light

- (1) Seats should include a reading light that is positioned so as not to disturb neighbor during nighttime hours.
- (2) Passengers should be able to adjust the lighting angle to cast light over the shoulder and into the lap or at a position suitable to read a book at night.
- (3) Light intensity should have three settings.

xi). Seat Recline Mechanism

- (1) Seat recline mechanism should allow the seat pan to slide forwards so as not to burden the full recline onto the passenger behind in addition to reclining the seat back.
- (2) It should be easy to use by people of all abilities.
- (3) The mechanism should be durable and rattle free.
- (4) It should be free from finger traps.

xii). Calf Rest Pad

- (1) Calf-rests tilt up for optimal leg support and comfort.
- (2) Angle and width to be optimized as part of a detailed human factors study.
- (3) The calf rest should be able to be operated independently from the seat pan.

xiii). Seat Controls

- (1) Seat controls for recline and leg rest should be located within easy reach of a customer - for example on the inner side of the outside armrests.
- (2) It should be possible to control the seat back recline and the calf rest independently.
- (3) The seat controls should be intuitive to use by people of abilities and shall require 3 lbf or less to operate.

xiv). Sliding Armrests

- (1) 2" wide armrest shall include a soft wrap around the top for comfort and a hard-wearing bottom wrap and side cap for durability.
- (2) Armrests should be included on both sides of the seat and in between a seat pair.
- (3) The aisle armrest must slide out of the way to provide an unobstructed approach to the seat pan so a person using a wheeled mobility device can complete a successful side transfer.
- (4) It is acceptable that a design that uses a folding armrest is adopted for dedicated transfer seats.

xv). Flexible Net Pocket

- (1) A storage pocket should be provided on the back of the seat.
- (2) A semi-rigid frame with a net suitable for passengers to store personal items or for Amtrak literature.
- (3) The net should be durable and allow a clear view of the items placed inside to aid quick and easy cleaning routines.
- (4) The design should allow for this element to be quickly and easily replaced on the train.

xvi). On-Seat Power

- (1) Two USB ports should be provided on the back of each of the seats.
- (2) Two duplex plug sockets should be located on the seat pedestal. Sockets should be shielded from spills from the table or cup holder.

xvii). Central Foot Pedestal

- (1) A central seat pedestal should be positioned to maximize foot clearance.
- (2) Interface with the floor should allow easy cleaning.

xviii). Fold Out Table

- (1) An airline style bi-fold table should deploy from central console.
- (2) The usable surface should allow people to use at least a 15" laptop.
- (3) The table should also be able to track forward and back when deployed.
- (4) The mechanism should be durable and rattle free.
- (5) The size and resting position will be subject to mockup review, testing, and Amtrak approval.
- (6) When the table is deployed it shall be able to support a 50lbf point load on the end of the table without damage.

xix). Cup Holders

- (1) A fold out metal cup holder on each seat should be deployed from central console.
- (2) It should be positioned within easy reach of the passenger.
- (3) Cup holders should store in a position free from the movement of the seat and outside of knee and leg room.
- (4) The cupholder should be capable of storing and securing cups of various diameters.
- (5) It should be designed to prevent passing passengers getting snagged.

xx). Device Holder

- (1) A fold out ledge with clip should allow the secure mounting of passengers' personal devices.
- (2) The clip should be sprung and adjustable so different sizes can be securely kept in place including a typical tablet and/or a smart phone.
- (3) The angle should be set so it is usable in both recline and upright positions.
- (4) The latch should be designed in such a way to prevent accidental activation.

xxi). Fold out Footrest

- (1) A fold out adjustable footrest should be provided.
- (2) There should be three set positions and the footrest should have a degree of angle adjustment.

- (3) The footrest should be durable to prevent damage is passengers misuse (e.g. step on accidentally while climbing in to aisle from window).
 - (4) The size and positions should be defined by a detailed human factors study.
- e). Functional Elements
- i). Seat Recline to Lazy Z
 - (1) Recline features- when seats are fully reclined there shall be at least 8" of knee clearance and 2" of foot clearance for a 95th percentile male between the back of the seat in front of the passenger and his knees.
 - (2) The recline features shall be operated manually:
 - (a) The seatback shall recline
 - (b) The seatpan shall recline to raise the knees upwards
 - (c) The calf rest shall extend forward to raise the legs
 - (d) The footrest shall be able to be folded out and adjust in length to support the feet
 - (3) As an option, a motorized and power assisted option for items 1-3 (above) shall be available for Amtrak to exercise upon request.
 - (a) If motorized and power assisted options are exercised, the seat shall be capable of adjustment manually in the event of power loss or malfunction.
 - ii). Seat Rotation
 - (1) The seats shall be installed all facing the same direction the right and left sides of the aisle.
 - (2) Rotation features shall be included for the premium seats.
 - (a) Seats should have the capability to rotate at the end of the line so that all seats are facing the opposite direction.
 - (b) This rotation would be manually performed by Amtrak staff.
 - (c) Each seat bench should be able to be rotated in less than 30 sec and shall lock in place.
 - (d) A visual indicator of the seat being properly secured shall be provided.

- (3) As an option, Amtrak shall be able to elect to have rotation features for each of the seats in standard coach. If exercised, the seats shall all be installed facing the same direction on both sides of the aisle.
 - (a) Seats should have the capability to rotate at the end of the line so that all seats are facing the opposite direction.
 - (b) This rotation would be performed by Amtrak staff at the push of a button and the rotation and locking shall be power assisted.
 - (c) If motorized and power assisted options are exercised, the seat shall be capable of adjustment manually in the event of power loss or malfunction.
 - (d) Each seat bench should be able to be rotated in less than 30 sec and shall lock in place.
 - (e) A visual indicator of the seat being properly secured shall be provided.
 - (f) Any seat not fully locked into place shall send an alert to the conductor for inspection.
 - (g) The controller shall report alerts and faults to the car diagnostic system. See Chapter 24 for additional information.
- f). Additional Equipment Requirements
 - i). Emergency Equipment
 - (1) Seats shall not obstruct emergency windows and, to the extent possible, shall be arranged to optimize passenger access to window views.
- g). CMF
 - i). Please refer to the attached CMF document (Exhibit F-2) for exact color, material, and finishes desired in this sleeper cabin area. Please also refer to Chapter 19.
 - ii). All colors, cushions, fabrics, and appearance shall be as directed by Amtrak.
 - iii). All revenue passenger seats shall share the same common design appearance.
 - iv). Individual components shall be interchangeable wherever possible.
 - v). They shall have a profile that is free of sharp corners and edges.
 - vi). All seat coverings shall use synthetic leather.
 - vii). Arm rests, if upholstered, shall use the same covering as the seats.

- viii). Final construction of the cushions including sewing and fire blocking shall be subject to the approval of Amtrak.

11.42 Accessible Seating Spaces for Wheeled Mobility Users

- a). Passengers who wish to transfer from wheeled mobility device
 - i). Designated transfer seat positions shall be reserved for passengers who wish to transfer from their wheeled mobility devices into a standard or premium coach seat.
 - ii). Each transfer seat shall be of identical design and appearance to the other passenger seats.
- b). Passengers who wish to remain in wheeled mobility device
 - i). Designated spaces shall be reserved for passengers who wish to remain in their wheeled mobility device.
 - ii). Each designated space shall include the features described for a seated standard coach or premium coach passenger. This includes the following features:
 - (1) Reading Light
 - (a) Seating spaces should include a reading light that is positioned so as not to disturb neighbor during nighttime hours.
 - (b) Passengers should be able to adjust the lighting angle to cast light over the shoulder and into the lap or at a position suitable to read a book at night.
 - (c) Light intensity should have three settings.
 - (2) Flexible Net Pocket
 - (a) A storage pocket should be provided adjacent to the seating space.
 - (b) A semi-rigid frame with a net suitable for passengers to store personal items or for Amtrak literature.
 - (c) The net should be durable and allow a clear view of the items placed inside to aid quick and easy cleaning routines.
 - (d) The design should allow for this element to be quickly and easily replaced on the train.
 - (3) Seat Power
 - (a) Two USB ports should be provided adjacent to each of the seats.

- (b) Two duplex plug sockets should be accessible by a seated passenger. Sockets should be shielded from spills from the table or cup holder.
- (4) Cup Holders
 - (a) A fold out metal cup holder at each seating space should be deployed and positioned within easy reach of the passenger.
 - (b) Cup holders should store in a position free from the movement of the seat and outside of knee and leg room.
 - (c) The cupholder should be capable of storing and securing cups of various diameters.
 - (d) It should be designed to prevent passing passengers getting snagged.
- (5) Device Holder
 - (a) A fold out ledge with clip should allow the secure mounting of passengers' personal devices.
 - (b) The clip should be sprung and adjustable so different sizes can be securely kept in place including a typical tablet and/or a smart phone.
 - (c) The angle should be set so it is usable in both recline and upright positions.
 - (d) The latch should be designed in such a way to prevent accidental activation.
- (6) Adjustable Workstation Table
 - (a) ADA compliant and adjustable height workstation table shall be provided for all wheeled mobility spaces.
- iii). If rotating seat options are exercised by Amtrak, access to the features listed above shall be maintained for passengers who wish to remain in their wheeled mobility device.

11.43 Tables

a). Attachment Criteria

- i). In the event that Amtrak elects to have some locations with facing seat pairs, a fixed workstation table shall be provided compliant with APTA Standard PR-CS-S-018-13.
- ii). Energy absorption features shall be built into the workstation table and/or its attachments such that human injury criteria for the 50th percentile HIII male ATDs are not exceeded during dynamic sled testing, per the requirements

specified in APTA Standard PR-CS-S-018-13, Section 5.2.1, modified for testing with a workstation table installed.

- iii). The table must meet the performance requirements specified in Section 5.2.1.3 of APTA Standard SS-C&S 016-99.
 - iv). The table must not become detached from its mountings and the ATDs must remain compartmentalized between the table and the launch seat.
 - v). Workstation tables shall be attached to the carbody via the wall seat track and to the floor seat track.
 - vi). Workstation tables shall support a 50lbf point load at the edge of the table without damage.
- b). Key Features
- i). The top shall have dimensions that allow easy access to the seats from the aisle while also optimizing the table dimensions for ergonomics.
 - ii). The tabletop shall have a high-pressure laminate top surface and smooth edge that is free of sharp edges and burrs.
 - iii). The top shall have a raised perimeter to retain spilled liquids.
 - iv). Workstation tabletop dimensions shall have a width that approximately matches the width of the seat assemblies.
 - v). Depth of business class tables shall be increased from coach class to match the increased seat pitch.
 - vi). Locations of mounting holes and tolerances shall be consistent, so any leg can be used with any table with no modifications required; likewise, for the connection to the leg to the floor seat track.
 - vii). The use of magnets in tables is prohibited.
- c). Accessible Seating Worktables
- i). Workstation tables shall be provided for each location where a passenger can ride the train in coach while staying in their wheeled mobility device.
 - ii). Workstation tables shall be adjustable in height from 27" to 32" from the floor.
 - iii). The area near the workstation table shall have a safety card holder.

Part VII: Restrooms

11.44 Restrooms - General

a). General

- i). Restrooms shall comply with water and waste system equipment requirements detailed in Chapter 15.
- ii). The highest levels of winterization protection in the design of the toilet room shall be provided.
- iii). Accessibility requirements for labeling in the restroom from Chapter 26 shall be followed. Please also reference signage from Section 11.6.
- iv). All parts of the toilet room and associated water and waste piping shall have complete maintenance access provided to all components.
- v). All toilet room fixtures, dispensers and appliances shall be constructed in accordance with the requirements of the US Public Health Service and 21 CFR Part 1250 requirements and ATR shall meet the ADA requirements of 49 CFR Part 38.123.
- vi). Complete details of the toilet room, including maintainability analysis and winterization details, shall be presented for Amtrak approval during design review, and they shall be included in the interior mock-ups.

b). Floor Pan

- i). The floor pan of the toilet room modules shall be FRP with 1.5 in. minimum radii corners to eliminate the accumulation of debris and aid in cleaning.
 - (1) A stainless-steel overflow pan shall be provided under the toilet and water connections.
 - (2) A waterproof rubber flooring covering which reduces noise and resists accumulation of odors shall be provided.
 - (3) The purpose is to prevent fluids from wicking beneath the toilet room flooring, both for hygiene and to prevent degradation of the subflooring materials.
 - (4) This pan shall be watertight and have raised edges of at least 4 in. in height. The pan's exposed edges shall be folded for safety and to provide stiffness.
 - (5) The floor pan shall be installed over the subfloor of the car, and the perimeter of the pan shall be fully sealed to prevent moisture from seeping under the pan.

- (6) Attachment points to secure the floor pan to the subfloor shall be in the sides, rather than the bottom surface, and be watertight. The floor pan joint at the door opening shall be waterproof to the subfloor.
 - (7) Floor penetrations shall be avoided, when possible, but where required, sealed to make the joint waterproof and with an appropriate material to prevent flame propagation from underfloor flame sources.
- c). Floor Covering
- i). A seam-free, skid-resistant rubber floor covering, solid surface material, or approved coating shall be used in the toilet room floor area.
 - ii). Color and pattern selection shall be approved by Amtrak.
 - (1) The floor covering shall be covered a minimum 4 in. up the sidewalls to form the inside scuff/kick plate.
 - (2) The edges shall be sealed to form a watertight seal.
- d). Drainage
- i). A provision shall be provided for a floor drain in the toilet room pan that shall be reviewed with Amtrak during Design Review.
 - (1) The floor shall be properly may be sloped toward the drain, preferably located near the toilet and an intumescent device shall be utilized to seal the drain in case of a fire, or alternate approved design.
- e). Attachment Strength of Fittings
- (1) The fittings in toilet rooms shall meet the attachment strength requirements defined in 49 CFR Part 238.233.
- f). CMF
- i). Wall Panels
 - (1) Sidewall Panels along the carshell wall shall be made from molded thermoplastic with an easy to clean surface finish.
 - (2) Partition Walls shall be created from a composite structure such as aluminum honeycomb or HPL skinned honeycomb panels.
 - (3) The finish of the wall and material of the outside skin shall be inspired by the CMF document (Exhibit F-2) and meet all structural requirements for crashworthiness based on mounting and attached loads to the panel.
 - ii). Ceiling
 - (1) Ceiling shall be created from a composite structure such as aluminum honeycomb or HPL skinned honeycomb panels.

- (2) The finish of the passenger facing side of the ceiling panel and material of the outside skin shall be inspired by the CMF document (Exhibit F-2) and meet all structural requirements for crashworthiness based on mounting and attached loads to the panel.
 - (3) The finish of the material on the non-passenger facing side shall be coated such that there is no risk of corrosion from moisture from steam or humidity within the car.
- iii). Flooring
- (1) Flooring within the restroom area shall be made from rubber flooring with a friction, no-slip texture.
 - (2) Flooring will be durable to withstand spills, leaks, and all methods of cleaning. Flooring shall also not become frequently damaged or worn.
 - (3) Flooring shall have enough give to prevent fatigue from standing.

11.45 Standard Toilet Room (STR)

a). General

- i). The STR shall have the ability to be used in two orientations.
- ii). A modular design that allows different door positions should provide flexibility for the layout of the interior architecture.
- iii). The orientation should always prioritize seats and passenger accommodation numbers where possible, while providing options for better aisle access in other instances.
- iv). To the extent possible equipment, parts, and features in the STR shall be identical to equipment, parts, and features in the restrooms for sleeper cabins.
- v). The intent of this clause is to minimize spares and maintenance techniques.
- vi). Please refer to Chapter 1 for information regarding quantity of this accommodation type desired across the trainset and suggested layouts.
- vii). To the extent possible, the Contractor shall adhere to the general arrangement images for the Standard Toilet Room as shown in Figure 11-60 on page 11-319.

b). Key Features

- i). A comprehensive list of expected features in the Standard Toilet room is provided in Figure 11-12, and described in detail below.
- ii). Detailed functional requirements for each feature is listed below. In addition to these requirements, the Contractor shall factor in safety, crashworthiness,

materials and workmanship, FDA cleaning clearances, radii, and sanitary design.

iii). Restroom Door

- (1) The door should open inwards as a bifold door, similar to an airline toilet door.
- (2) The door should be sealed to prevent leaking water escaping into the internal space of the car.
- (3) The door should lock from the inside, with an indicator on the outside showing the door lock status.
- (4) The clear width door opening shall be a minimum of 24".
- (5) The door shall be of lightweight construction, consistent with durability and be secured with stainless-steel hinges.
- (6) The door shall be free from resonance and rattles when in the closed position when the train is in motion at any permissible speed.
- (7) The door frame and attachment of the keeper shall be sufficiently rigid so that it does not flex when the door closes, even if it is slammed; the intention is that this interface does not deteriorate over the life of the car.
- (8) Likewise, interior door construction shall incorporate interior stiffening in the area where the lock/ latch is attached to the door, so that the fasteners securing it to the leaf have a solid surface on which to clamp.
- (9) The door latch, with a handle on both sides of the door, shall engage automatically when the door moves towards a closed position, but the lock requires definite action to engage.
- (10) The door shall remain in the fully closed position at any permissible train speed.
- (11) The lock shall be operable, in an emergency, from the outside with a standard Amtrak coach key.
- (12) An instruction, in accordance with Amtrak Specification # 697, located on the interior side of the door, shall provide lock operating instructions.

Figure 11-12: Key Features - Standard Toilet Room

Feature	Short Description	Qty
Restroom Door	Bifold or sliding door for entrance into STR	1
Toilet	Assembly including toilet bowl, shroud, and overflow pan	1
Toilet Seat	Assembly including lid and seat for toilet	1
Toilet Flush	Push button flush and automatic flush mechanisms	1
Toilet Paper Dispenser	Protective location for dispensing toilet paper	1
Toilet Seat Cover Dispenser	Protective location for dispensing seat covers	1
Sanitary Waste	Storage location for used feminine hygiene products	1
Sharps Bin	Storage location for used needles and other medical waste	1
Sink	Solid surface sink counter and basin	1
Hand Dryer	Automatic hand dryer and paper towel dispenser	1
Vanity Mirror	Mirror for passenger to look while washing hands	1
Trash	Storage for restroom related trash	1
Grab Handles	49 CFR 38.115 compliant handrails	1
Baby Changing Table	Fold out table for infant diaper care	1
Crew Storage	Locker with square key for dedicated crew storage	1
Coat Hooks	Coat hooks that hold up to 25lbs	2
PEI- Intercom only	Speaker for emergency conversations	1
Emergency Call Button	Buttons in accessible locations that activate PEI	2
Exhaust	Adjustable exhaust grille	1

iv). Toilet

- (1) A toilet, complete with toilet bowl assembly, shroud, and overflow pan shall be provided in the restroom.
- (2) Toilet bowl Assembly
 - (a) A toilet stand with shroud assembly shall be located in the toilet room. Each restroom shall be equipped with a toilet bowl assembly, encased in the toilet shroud.
- (3) Toilet shroud
 - (a) The shape of the toilet shroud housing shall locate the toilet seat ergonomically for ease of use and comfort.
 - (b) Sufficient foot room shall be provided.
 - (c) When seated, the user's legs shall not contact the shroud.
 - (d) The toilet shroud shall be constructed of FRP with gel coat color to match the restroom shell or of stainless steel, with brushed finish or approved alternate.
- (4) Toilet Overflow Pan
 - (a) The toilet bowl assembly shall be mounted on a stainless-steel overflow pan, which shall contain flooding should the toilet outlet become blocked or system leak.
 - (b) The overflow pan shall be watertight with raised edges of ~2 inches height, have the attachment points exterior to the pan, have all exposed edges folded for safety and to provide stiffness, and be equipped with an overflow tube.

v). Toilet Seat

- (1) A standard toilet seat and toilet lid shall be provided.
- (2) Toilet seat and seat lid should have soft close mechanisms.
- (3) A white toilet seat with lid, meeting Amtrak Specification # 352, shall be provided.
- (4) The toilet seat and cover shall be constructed of reinforced fiberglass or approved alternate.
- (5) The lid and seat shall be stable in the up position regardless of train motion, including braking, to prevent it from slamming down suddenly against the shroud.

vi). Toilet Flush Mechanism

- (1) A two-button push flush shall be located on the back wall of the restroom above the toilet.
 - (2) This shall provide standard and eco flush features for the passenger.
 - (3) The flush mechanism shall also incorporate an automatic flushing feature when the passenger is done using the toilet.
- vii). Toilet Paper Dispenser
- (1) A toilet paper dispenser shall be provided adjacent to the toilet.
 - (2) This dispenser shall protect the toilet paper from getting wet.
- viii). Toilet Seat Cover Dispenser
- (1) A dispenser for paper toilet seat covers should be located by the toilet.
- ix). Sanitary Waste Disposal
- (1) A sanitary waste bin shall be provided to the right of the toilet complete with modesty flap. The minimum volume for this bin shall be 7 gallons.
- x). Sharps Bin
- (1) Provision for a sharps bin should be provided within the room.
 - (2) The size, position, and method of removal of sharps should be agreed and instructed by Amtrak.
- xi). Sink
- (1) General
 - (a) A solid surface sink with hot and cold water faucet shall be provided for passengers.
 - (b) The sink countertop shall be made from solid surface material and shall include a marine edge, 6" backsplash, and $\frac{3}{4}$ " radius for cleanability.
 - (c) Note that all sink countertops shall be sloped toward the basin and drain.
 - (2) Sink Basin
 - (a) The sink basin shall have minimum internal dimensions of 18" width x 10" length x 5" depth.
 - (b) The sink shall have a 1/2 to 1 gallon capacity and be equipped with an overflow.

- (c) The sink shall be drained through a nominal 1-1/4" diameter drain.
- (3) Faucet
 - (a) The faucet shall be mounted behind the sink.
 - (b) The faucet shall use IR sensor to control water dispensing.
 - (c) Water flow from the faucet shall be directed into the sink and not splash the user.
 - (d) Faucet shall be hardwired for power with a battery backup.
- (4) Soap Dispenser
 - (a) An automatic liquid soap dispenser which will accept a Celeste Industries liquid soap refill shall be installed and shall be located adjacent to the mirror.
 - (b) Power for the soap dispenser shall be hardwired with a battery back up.
- (5) 120V outlet
 - (a) A duplex 120VAC GFCI receptacle shall be located on a panel adjacent the sink, preferably located to keep it dry from splashes from the sink.
- xii). Hand Dryer
 - (1) A high velocity motion-activated hand dryer and a paper towel holder shall be mounted on the wall of near the sink in an easily accessible location.
- xiii). Vanity Mirror
 - (1) A large 41.5" x 23" mirror shall be positioned in front of the sink. The mirror can be split into two sections as necessary.
- xiv). Trash
 - (1) A trash bin shall be provided under the sink with push flap cover.
 - (2) The minimum volume of trash for this receptacle shall be 2 cu ft.
 - (3) The trash flap for this receptacle shall be a minimum of 10" x10".
- xv). Grab Handles
 - (1) Stainless-steel grab bars shall be provided on one side of the restroom to allow passengers to steady themselves against train motion.

- (2) Bars shall be directly secured to car secondary structure or module structure.
 - (3) These bars shall be anti-slip grab bars in accordance with Subpart F of 49 CFR Part 38.123 (a) (3) shall be provided for passengers to utilize while using the facility.
- xvi). Baby Changing Table
- (1) A baby changing table should be provided.
 - (2) The changing table should be easy to deploy and stow with an intuitive handle.
 - (3) The mechanism should be durable, free from jamming and racking.
 - (4) The design should meet abuse loads.
 - (5) It should have a soft opening mechanism.
- xvii). Crew Storage
- (1) A crew storage cabinet shall be provided at high elevations in the restroom for storage of restroom and cleaning supplies.
- xviii). Coat Hooks
- (1) Two coat hooks shall be provided on the partition wall. Coat hooks shall be capable of supporting up to 25lbs each.
 - (2) These hooks are identical to the towel hooks provided in the sleeper cabin.
- xix). Emergency Call Button
- (1) Two waterproof Emergency Call Buttons shall interface with the Passenger Emergency Intercom (PEI) in the toilet room.
 - (2) The Emergency Call Buttons are providing better access for passengers if they are not able to reach the PEI unit.
 - (a) The Emergency Call buttons shall have illuminated and audible indications when actuated.
 - (b) One Emergency Call button shall be located within easy reach while seated on the toilet and not easily confused with the flush button or other controls
 - (c) A second button located within 12 inches from the floor or otherwise reachable for someone who has fallen.
 - (d) Placement of the buttons is subject to approval during design review.

- (3) The PEI in the toilet room shall interface with the Emergency Call Buttons.
 - (a) The PEI and Emergency Call button arrangement, including the interfaces used between them, must maintain the same safety level and a standalone PEI.
 - (b) The PEI and Emergency Call Buttons must remain functional under any toilet module degraded mode condition.
 - (c) See Chapter 14 for additional details.
- xx). Exhaust
 - (1) An exhaust grille shall be provided in the ceiling.
 - (2) Negative pressure in the restroom shall be provided by the HVAC system.
- c). Additional Equipment Requirements
 - i). HVAC
 - (1) Supply Air Diffusers
 - (a) Conditioned air is delivered to the room via 2 supply air diffusers with adjustable air flow control and located on the windowsill of the outside window.
 - (b) Air vents should take less than 3 lbf to operate and adjust.
 - (2) Exhaust Grille
 - (a) Exhaust air is removed from the room via the exhaust air grille which is located at the upper portion of the module.
 - ii). Outlet
 - (1) Outlet to be provided within crew storage cabinet for maintenance and cleaning access (see Figure 11-61 on page 11-320).
 - iii). Lighting
 - (1) General
 - (a) Lighting general information is shared in the points below.
 - (b) Detailed lighting information can be found in Chapter 13.
 - (c) All lighting part numbers, manufacturers, and temperatures shall be proposed by the Contractor and approved at Amtrak after the lighting simulation during the design review process.

- (2) Main Ceiling Light (White Light)
 - (a) A large rectangular LED panel in the ceiling provides the main source of light for the room.
- (3) Compartment Light (RGB Lights)
 - (a) Floor Lights
 - (i) Lights shall be provided as indirect lighting that spills out across the floor under the sink counter.
 - (b) Sink Lights
 - (i) A wash light should be used to light the sink area indirectly.
 - (ii) This light shall only be activated when the door to the restroom is locked.
 - (c) Crew Storage Light
 - (i) Cabinet shall include an internal light source that activates when the door is opened.
 - (d) Mirror Light
 - (i) A LED light shall illuminate the mirror around the boarder.
 - (ii) This light shall only be activated when the door to the restroom is locked.
 - (e) Baby Changing Table
 - (i) Indirect lighting shall wash down the baby changing wall when the changing table is deployed.
 - (ii) Angle and brightness of light shall be approved by Amtrak during mockup review.
 - (iii) The design shall make efforts to avoid accidental direct light to the eyes of a baby on the changing table.
- (4) See Figure 11-62 on page 11-321.
- iv). Communications
 - (1) Speaker
 - (a) PA speaker shall be located on the central ceiling panel.
 - (b) The PA speaker shall have an associated mute button.

- (c) The speaker used in this location shall be identical to PA speakers used in other locations in the trainset for ease of maintenance and replacement.
 - (2) All communications equipment shall meet the requirements in Chapter 14.
- v). Emergency Equipment
 - (1) Smoke Detector
 - (a) Smoke Detectors shall be mounted on the central ceiling panel.
 - (b) The smoke detector used in this location shall be identical to the smoke detectors used in other locations in the trainset for ease of maintenance and replacement.
- vi). Security
 - (1) Many items within the coach area will need to be secured.
 - (2) The following items are identified with specific locking preferences:
 - (a) Restroom Door Locking Mechanism
 - (3) Any other locking or security items will be discussed with Amtrak during design reviews.
- d). CMF
 - i). Please refer to the attached CMF document (Exhibit F-2) for exact color, material, and finishes desired in this restroom area. Please also refer to Chapter 19.

11.46 Accessible Toilet Room (ATR)

- a). General
 - i). All features shall be reached by a person sitting in a wheeled mobility device unless otherwise listed in this section.
 - ii). Dimensions and anthropomorphic data shall be taken from the Americans with Disabilities Act.
 - iii). Additionally, the ATR shall conform with 49 CFR 38.123.
 - iv). To the extent possible equipment, parts, and features in the ATR shall be identical to equipment, parts, and features in the restrooms for sleeper cabins.
 - v). The intent of this clause is to minimize spares and maintenance techniques.

- vi). Please refer to Chapter 1 for information regarding quantity of this accommodation type desired across the trainset and suggested layouts.
 - vii). To the extent possible, the Contractor shall adhere to the general arrangement images for the Accessible Toilet Room as shown in Figure 11-63 on page 11-322.
- b). Key Features
- i). A comprehensive list of expected features in Accessible Toilet Rooms is provided in Figure 11-13 and described in detail below.
 - ii). In addition to these requirements, the Contractor shall factor in safety, crashworthiness, materials and workmanship, FDA cleaning clearances, radii, and sanitary design.

Figure 11-13: Key Features - Accessible Toilet Room

Feature	Short Description	Qty
Restroom Door	Curved and automatic door for ATR	1
Toilet	Assembly including toilet bowl, shroud, and overflow pan	1
Toilet Seat	Assembly including lid and seat for toilet	1
Toilet Flush	Push button flush and automatic flush mechanisms	1
Toilet Paper Dispenser	Protective location for dispensing toilet paper	1
Toilet Seat Cover Dispenser	Protective location for dispensing seat covers	1
Sanitary Waste	Storage location for used feminine hygiene products	1
Sharps Bin	Storage location for used needles and other medical waste	1
Sink	Solid surface sink counter and basin	1
Hand Dryer	Automatic hand dryer and paper towel dispenser	1
Vanity Mirror	Mirror for passenger to look while washing hands	
Trash	Storage for restroom related trash	1
Grab Handles	49 CFR 38.115 compliant handrails	1
Baby Changing Table	Fold out table for infant diaper care	1
Crew Storage	Locker with square key for dedicated crew storage	1
Coat Hooks	Coat hooks that hold up to 25lbs	2
Full Length Mirror	Long mirror mounted on sidewall of restroom or cabinet	1
PEI- Intercom only	Speaker for emergency conversations	1
Emergency Call Button	Buttons in accessible locations that activate PEI	2
Exhaust	Adjustable exhaust grille	1

iii). Restroom Door

- (1) The door should be a curved automatic sliding door.
- (2) The door should be sealed to prevent water escaping into the internal space of the car.
- (3) The door should lock from the inside, with an indicator on the outside showing the door lock status.
- (4) The restroom door shall also be able to operate in a manual mode in the event of power loss or malfunction so that the restroom is not put out of service due to door operation failure.
- (5) The clear width door opening shall be a minimum of 44".
- (6) The door shall be of lightweight construction.
- (7) The door shall be free from resonance and rattles when in the closed position when the train is in motion at any permissible speed.
- (8) The door frame and attachment of the keeper shall be sufficiently rigid so that it does not flex when the door closes.
- (9) The intention is that this interface does not deteriorate over the life of the car.
- (10) Likewise, interior door construction shall incorporate interior stiffening in the area where the lock/ latch is attached to the door, so that the fasteners securing it to the leaf have a solid surface on which to clamp.
- (11) The door latch, with a handle on both sides of the door, shall engage automatically when the door moves towards a closed position, but the lock requires definite action to engage.
- (12) The door shall remain in the fully closed position at any permissible train speed.
- (13) The lock shall be operable, in an emergency, from the outside with a standard Amtrak coach key.
- (14) An instruction, in accordance with Amtrak Specification # 697, located on the interior side of the door, shall provide lock operating instructions.

iv). Toilet

- (1) General
 - (a) A toilet, complete with toilet bowl assembly, shroud, and overflow pan shall be provided in the restroom.
- (2) Toilet Bowl Assembly

- (a) A toilet stand with shroud assembly shall be located in the toilet room. Each restroom shall be equipped with a toilet bowl assembly, encased in the toilet shroud.
- (3) Toilet Shroud
 - (a) The shape of the toilet shroud housing shall locate the toilet seat ergonomically for ease of use and comfort.
 - (b) Sufficient foot room shall be provided.
 - (c) When seated, the user's legs shall not contact the shroud.
 - (d) The form of the toilet should be floating or undercut at the bottom to maximize wheeled mobility device clearance.
 - (e) The toilet shroud shall be constructed of FRP with gel coat color to match the restroom shell or of stainless steel, with brushed finish or approved alternate.
- (4) Toilet Overflow Pan
 - (a) The construction of the toilet in this room prevents a separate toilet overflow pan.
 - (b) Therefore, the entire ATR will be treated as an overflow pan in terms of preventative measures for water damage.
 - (c) The floor pan features described above are critical in this module.
- v). Toilet Seat
 - (1) A standard toilet seat and toilet lid shall be provided. Toilet seat and seat lid should have soft close mechanisms.
 - (2) A white toilet seat with lid, meeting Amtrak Specification # 352, shall be provided.
 - (3) The toilet seat and cover shall be constructed of reinforced fiberglass or approved alternate.
 - (4) The lid and seat shall be stable in the up position regardless of train motion, including braking, to prevent it from slamming down suddenly against the shroud.
- vi). Toilet Flush Mechanism
 - (1) A two-button push flush shall be located on the back wall of the restroom above the toilet.
 - (2) This shall provide standard and eco flush features for the passenger.

- (3) The toilet flush buttons shall be mounted no more than 44" from the floor.
- (4) The flush mechanism shall also incorporate an automatic flushing feature when the passenger is done using the toilet.
- vii). Toilet Paper Dispenser
 - (1) A toilet paper dispenser shall be provided adjacent to the toilet. This dispenser shall protect the toilet paper from getting wet.
- viii). Toilet Seat Cover Dispenser
 - (1) A dispenser for paper toilet seat covers should be located by the toilet.
- ix). Sanitary Waste Disposal
 - (1) A sanitary waste bin shall be provided to the right of the toilet complete with modesty flap.
 - (2) The minimum volume for this bin shall be 0.25 cu ft.
- x). Sharps Bin
 - (1) Provision for a sharps bin should be provided within the restroom.
 - (2) The size, position, and method of removal of sharps should be agreed and instructed by Amtrak.
- xi). Sink
 - (1) General
 - (a) A solid surface sink with hot and cold water faucet shall be provided for passengers.
 - (b) The sink countertop shall be made from solid surface material and shall include a marine edge, 6" backsplash, and $\frac{3}{4}$ " radius for cleanability.
 - (c) The sink countertop shall be approximately 32" from the floor and no more than 34" from the floor.
 - (d) Note that all sink countertops shall be sloped toward the basin and drain.
 - (2) Sink Basin
 - (a) The sink basin shall have minimum internal dimensions of 11" width x 16" length x 5" depth.
 - (b) The sink shall have a 1/2 to 1 gallon capacity and be equipped with an overflow.

- (c) The sink shall be drained through a nominal 1-1/4" diameter drain.
- (3) Faucet
 - (a) The faucet shall be mounted behind the sink. The faucet shall use IR sensor to control water dispensing. Water flow from the faucet shall be directed into the sink and not splash the user.
- (4) Soap Dispenser
 - (a) An automatic liquid soap dispenser which will accept a Celeste Industries liquid soap refill shall be installed and shall be located adjacent to the mirror.
 - (b) Power for the soap dispenser shall be hardwired with a battery back up.
- (5) 120V Outlet
 - (a) A duplex 120VAC GFCI receptacle shall be located on a panel adjacent the sink, preferably located to keep it dry from splashes from the sink.
- xii). Hand Dryer
 - (1) A high velocity motion-activated hand dryer and a paper towel holder shall be mounted on the wall of near the sink in an easily accessible location.
- xiii). Vanity Mirror
 - (1) A large mirror shall be positioned in front of the sink at an angle that allows both standing and sitting passengers to use adequately.
- xiv). Trash
 - (1) A trash bin shall be provided under the sink with push flap cover.
 - (2) The minimum volume of trash for this receptacle shall be 2.25 cu ft.
 - (3) The trash flap for this receptacle shall be a minimum of 10" x10".
- xv). Grab Handles
 - (1) Stainless-steel grab bars shall be provided on one side of the restroom to allow passengers to steady themselves against train motion.
 - (2) Bars shall be directly secured to car secondary structure or module structure.

- (3) These bars shall be anti-slip grab bars in accordance with Subpart F of 49 CFR Part 38.123 (a) (3) shall be provided for passengers to utilize while using the facility.

xvi). Baby Changing Table

- (1) A baby changing table should be provided.
- (2) The changing table should be easy to deploy and stow with an intuitive handle.
- (3) The mechanism should be durable, free from jamming and racking.
- (4) The design should meet abuse loads.
- (5) It should have a soft opening mechanism.

xvii). Crew Storage

- (1) A crew storage cabinet shall be provided at high elevations in the restroom for storage of restroom and cleaning supplies.

xviii). Coat Hooks

- (1) Two coat hooks shall be provided on the partition wall.
- (2) Coat hooks shall be capable of supporting up to 25lbs each.
- (3) These hooks are identical to the towel hooks provided in the sleeper cabin.

xix). Full Length Mirror

- (1) A full length mirror shall be provided in addition to the sink mirror.
- (2) The bottom edge of the reflective surface shall be a maximum of 40" from the floor.

xx). Emergency Call Button

- (1) Two waterproof Emergency Call Buttons shall interface with the Passenger Emergency Intercom (PEI) in the toilet room.
- (2) The Emergency Call Buttons are providing better access for passengers if they are not able to reach the PEI unit.
 - (a) The Emergency Call buttons shall have illuminated and audible indications when actuated.
 - (b) One Emergency Call button shall be located within easy reach while seated on the toilet and not easily confused with the flush button or other controls

- (c) A second button located within 12 inches from the floor or otherwise reachable for someone who has fallen.
 - (d) Placement of the buttons is subject to approval during design review.
 - (3) The PEI in the toilet room shall interface with the Emergency Call Buttons.
 - (a) The PEI and Emergency Call button arrangement, including the interfaces used between them, must maintain the same safety level and a standalone PEI.
 - (b) The PEI and Emergency Call Buttons must remain functional under any toilet module degraded mode condition.
 - (c) See Chapter 14 for additional details.
 - xxi). Exhaust
 - (1) An exhaust grille shall be provided in the ceiling. Negative pressure in the restroom shall be provided by the HVAC system.
- c). Accessibility Features
 - i). 44" Curved Toilet Door
 - (1) Access to the room will be subject to review and mockup user testing. Restroom doors should be and automatic sliding door.
 - ii). Handrail Locations
 - (1) Horizontal Handrails
 - (a) ADA compliant horizontal handrails positioned to assist transfer through the restroom shall be provided.
 - (b) The handrail should be positioned to provide maximum access and support for passengers.
 - (i) Adjacent to sink
 - (ii) On the wall behind toilet
 - (iii) Along the stationary curved wall.
 - (2) Vertical Handrails
 - (a) ADA compliant vertical handrails positioned to assist transfer through the restroom shall be provided.
 - (b) The handrail should be positioned to provide maximum access and support for passengers.

- (i) Adjacent to the toilet
 - (ii) On the wall near the door and baby changing table
 - iii). Control Buttons
 - (1) Room Door
 - (a) The controls for the room door must be ADA compliant in position, size, and configuration.
 - (i) Door Open/Close
 - (ii) Door Lock
 - (b) The buttons should be easy and intuitive to use.
 - (c) An accessible manual lock should be included with an indicator to show lock condition.
 - (d) The control buttons shall be located 12" minimum from the inside corner.
 - (e) The buttons should have visual and haptic feedback. Dimensions, position, and usability will be subject to Amtrak approval during mockup review.
 - (i) Note this review will include the disability community input.
- iv). 60" Turning Circle
 - (1) Center of room
 - (a) A clear 60" turning circle should be provided inside the room.
- v). Accessible Space for wheeled mobility devices
 - (1) A clear accessible space of 59" x 32" shall be provided for use of the sink and associated features.
 - (2) A clear accessible space of 59" x 32" shall be provided for use of the baby changing table, side transfer to toilet, and seat covers.
- d). Additional Equipment Requirements
 - i). HVAC
 - (1) Supply air diffusers
 - (a) Conditioned air is delivered to the room via 2 supply air diffusers with adjustable air flow control and located on the windowsill of the outside window.
 - (b) Air vents should take less than 3 lbf to operate and adjust.

- (2) Exhaust grille
 - (a) Exhaust air is removed from the room via the exhaust air grille which is located at the upper portion of the module.
- ii). Outlet
 - (1) Outlet to be provided within crew storage cabinet for maintenance and cleaning access (see Figure 11-64 on page 11-323).
- iii). Lighting
 - (1) General
 - (a) Lighting general information is shared in the points below. Detailed lighting information can be found in Chapter 13.
 - (b) Note that all lighting part numbers, manufacturers, and temperatures shall be proposed by the Contractor and approved at Amtrak after the lighting simulation during the design review process.
 - (2) Wall Wash Light (RGB Lights)
 - (a) Curved Wall Wash Light
 - (i) Indirect lighting that is washed down the curved wall.
 - (ii) This shall only be activated when the door is locked.
 - (b) Additional Mirror Wash Light
 - (i) Indirect light washing from behind the larger mirror frame.
 - (ii) This shall only be activated when the door is locked.
 - (c) Toilet Wall Wash Light
 - (i) This light should wash downwards from the toilet seat cover dispenser onto the toilet and area below.
 - (3) Main Ceiling Light (White Light)
 - (a) A large circular LED panel in the ceiling provides the main source of light for the room.
 - (4) Compartment Light (RGB Lights)
 - (a) Floor Lights
 - (i) Lights shall be provided as indirect lighting that spills out across the floor under the sink counter.
 - (b) Sink Light

- (i) A wash light should be used to light the sink area indirectly.
 - (ii) This light shall only be activated when the door to the restroom is locked.
 - (c) Crew Storage Light
 - (i) Cabinet shall include an internal light source that activates when the door is opened.
 - (d) Mirror Light
 - (i) A rounded LED light shall illuminate the mirror around the boarder.
 - (ii) This light shall only be activated when the door to the restroom is locked.
 - (e) Baby Changing Table Light
 - (i) Indirect lighting shall wash down the baby changing wall when the changing table is deployed.
 - (ii) Angle and brightness of light shall be approved by Amtrak during mockup review.
 - (iii) Design shall make efforts to avoid accidental direct light to the eyes of a baby on the changing table.
 - (f) See Figure 11-65 on page 11-324.
- e). Communications
 - i). Speaker
 - (1) PA speaker shall be located on the central ceiling panel.
 - (2) The PA speaker shall have an associated mute button.
 - (3) The speaker used in this location shall be identical to PA speakers used in other locations in the trainset for ease of maintenance and replacement.
 - (4) All communications equipment shall meet the requirements in Chapter 14.
- f). Emergency Equipment
 - i). Smoke Detector
 - (1) Smoke Detectors shall be mounted on the central ceiling panel.

- (2) The smoke detector used in this location shall be identical to the smoke detectors used in other locations in the trainset for ease of maintenance and replacement.
- g). Security
 - i). Many items within the sleeper cabin area will need to be secured.
 - ii). The following items are identified with specific locking preferences:
 - (1) Restroom Door Locking Mechanism
 - iii). Any other locking or security items will be discussed with Amtrak during design reviews.
- h). CMF
 - i). Please refer to the attached CMF document (Exhibit F-2) for exact color, material, and finishes desired in this restroom area. Please also refer to Chapter 19.

Part VIII: Sleeper Cabins

11.47 Sleeper Cabin General Requirements

- a). All sleeper cabins shall be designed and constructed to form a safe and attractive environment.
- b). Visible fasteners shall be minimized.
- c). Modularity shall be optimized during the design process and the outer walls of the modules shall be developed as a common component where possible.
- d). All mounted items in the room shall be secured to the module structure through the use of fully embedded tapping plates when pullout strength or expected weight is greater than 20 lbs.
 - i). These are expected to last the life of the car without coming loose.
- e). Space shall be incorporated, and mounting brackets be provided within the room walls to mount components required to provide functions of the adjustable features in the room, functions of the sink and functions of the toilet, but are preferably not visible.
- f). Consistent features shall be maintained across sleeper cabins to the extent possible.
- g). The Contractor shall provide a matrix table of interior features for each sleeper cabin and identify which items are repeatable for maintenance and maintainability management.
- h). Accessibility requirements for labeling in the restrooms in sleepers from Chapter 26 shall be followed.
- i). Please also reference signage from Section 11.6.
- j). Noise Cancelling or Sound Proofing
 - i). Noise cancelling or sound proofing features shall be implemented into the construction of all wall panels for each sleeper cabin.
 - ii). The noise reduction can come from acoustic dampening panels, foams, or other technology.
 - iii). The noises from adjoining compartments, hallways, and machinery shall be dampened to at least 65 dBA.
- k). Communications Equipment required in each sleeper cabin
 - i). Speaker
 - (1) PA speaker shall be located on the central ceiling panel.
 - (2) The PA speaker shall have an associated mute button.

- (3) The speaker used in this location shall be identical to PA speakers used in other locations in the trainset for ease of maintenance and replacement.
 - ii). All communications equipment shall meet the requirements in Chapter 14.
- l). Emergency Equipment required in each sleeper cabin
 - i). Smoke Detector
 - (1) Smoke Detectors shall be mounted on the central ceiling panel.
 - (2) The smoke detector used in this location shall be identical to the smoke detectors used in other locations in the trainset for ease of maintenance and replacement.
- m). Key Features in the passenger and crew sleeper cabins are described in Figure 11-14 through Figure 11-20 and Sections 11.48 through 11.64.
- n). A room-specific list of key features and description of additional requirements (Functional Elements, Accessibility Features, Security and Lighting) is provided for each sleeper cabin in Sections 11.48 through 11.54 and Section 11.77.

Figure 11-14: Key Features - Sleeper Cabins: General

		Roomette	Solo Suite	Club Bedroom	Premium Bedroom	Accessible Twin	Accessible Double	Accessible Premium Bedroom	Sleeper Cabin Showers	Crew Sleeper Cabin
Passengers (maximum)		2	1	4	2	2	2	4	n/a	1
Cabin Door	Standard Sleeper Cabin Door	1	1	1	1					1
	Accessible Sleeper Cabin Door					1	1	1		
	Accessible Sleeper Cabin Door Controls					2	2	2		
Restroom Door	Standard Sleeper Cabin Restroom Door			1	1					
	Accessible Sleeper Cabin Restroom Door					1	1	1		
	Accessible Sleeper Cabin Restroom Door Controls					2	2	2		
Shower Room Door	Standard Sleeper Cabin Shower Room Door				1				1	
	Accessible Sleeper Cabin Shower Room Door							1		
	Accessible Sleeper Cabin Shower Room Door Controls							2		
Fixed Glass Shower Panel									1	
Side Window	Side Window	1		1	2	1	1	2		1
	Side Window (smaller)		1							
Side Window Blinds	Sunshade	1	1	1	2	1	1	2		1
	Blackout Blind	1	1	1	2	1	1	2		1
	Automatic Operation (option)					1	1	2		
Skylight Window			1							
Skylight Window Blinds	Sunshade		1							
	Blackout Blind		1							
Solosuite Room Divider			1							
Solosuite Central Console			1							
Outlets	Duplex w/USB at Seat	2	1	2	4	4	4	4		2
	Duplex w/USB at Partition	2	2	2	3	2	1	3		2
	120VAC GFCI at Sink	1	1	1	1	1	1	1	1	1
	Minimum Outlets	5	3	5	8	7	6	8	1	4
Master Light Switches		2	1	2	1	2	1	2		2
Master Control Screen	Master Control Screen	1	1	1	1	1	1	1		1
	Screen Size	9"	9"	9"	12"	9"	9"	9"		9"
Master Thermostat Control		1	1	1	1	1	1	1		1
Floor Heat		per Chapter 10								
Grab Bars	Standard Grab Bars	as needed								
	Restroom Grab Bars	as needed								

Figure 11-15: Key Features - Sleeper Cabins: Communications

	Roomette	Solo Suite	Club Bedroom	Premium Bedroom	Accessible Twin	Accessible Double	Accessible Premium Bedroom	Sleeper Cabin Showers	Crew Sleeper Cabin
Passengers (maximum)	2	1	4	2	2	2	4	n/a	1
Digital Displays	per Figure 11-4								
Passenger Information Screen (PIS/OTIS)					1	1	1		
Attendant Call Button	Standard	1	1	1	1	1	1		1
	Waterproof			2					
Emergency Call Button					2	2	2	2	
PEI	PEI			1					
	PEI - Intercom Only				1	1	1	2	

Figure 11-16: Key Features - Sleeper Cabins: Seating Area / Lower Sleeping Berth / Bed

		Roomette	SoloSuite	Club Bedroom	Premium Bedroom	Accessible Twin	Accessible Double	Accessible Premium Bedroom	Crew Sleeper Cabin
Passengers (maximum)		2	1	4	2	2	2	4	1
Seat	Standard Sleeper Cabin	2	1	4		2	2	2	1
	Premium Sleeper Cabin				2				
	Tip Up Seat					1	1	2	
	Min. Width btw Armrests:	26"	34"	48"	22"	28"	28"	28"	26"
Armrest	Standard Sleeper Cabin	2	2	2		2	1	2	1
	Center					1	1	1	
Headboard	Standard Sleeper Cabin	2	1	2		1	1	2	1
	Premium Sleeper Cabin				1				
Ottoman	Crew Sleeper Cabin								1
	SoloSuite		1						
	Ottoman Table		1						
Adjustable Bed/Lounger					1				
Cup Holder		2	1	2	2	2	2	6	1
Bottle Holder			1	2		2	2	4	1
Fold Out Table	Single Leaf Table	1	1	1	1	2	2	4	
	Double Leaf Sliding Table								1
	min. Usable Surface:	18" x 18"	12.5" x 22"	18" x 26"	20" x 26"	12" x 22"	12" x 22"	12" x 22"	28" x 20"
	Extends from Sidewall:	20"	24"	28"	28"	24"	24	24	20"

Figure 11-17: Key Features - Sleeper Cabins: Upper Berth

	Roomette	SoloSuite	Club Bedroom	Premium Bedroom	Accessible Twin	Accessible Double	Accessible Premium Bedroom	Crew Sleeper Cabin
Passengers (maximum)	2	1	4	2	2	2	4	1
Upper Berth	1		1		1		1	
Upper Berth Grab Bar	1		1		1		1	
Upper Berth Steps	1		1					
Upper Berth Ladder					1		1	

Figure 11-18: Key Features - Sleeper Cabins: Personal Care

		Roomette	Solo Suite	Club Bedroom	Premium Bedroom	Accessible Twin	Accessible Double	Accessible Premium Bedroom	Sleeper Cabin Showers	Crew Sleeper Cabin
Passengers (maximum)		2	1	4	2	2	2	4	n/a	1
Drink Station					1			1		
Sink	Fold Out Sink	1	1							1
	Solid Surface Sink			1	1	1	1	1	1	
	Width:	8"	8"	8"	8"	15"	15"	15"		8"
	Length	9.5"	14"	11"	11"	11"	11"	11"		9.5"
	Depth:	3.7"	3.7"	5"	5"	5"	5"	5"		3.7"
Sink Vanity	Standard Sink Vanity Cabinet	1	1	1	1					1
	Accessible Sink Vanity Cabinet					1	1	1		
Sink Vanity Mirror	Sink Vanity Mirror	1	1	1	1	1	1	1	1	1
	Dimensions	10.5" x 30"	12" x 39"	13" x 28"	25" x 27.5"	25.5" x 25.5"	26" x 26"	TBD		TBD
Sink Vanity Shelves	Standard Sink Vanity Shelves				1					
	Accessible Sink Vanity Shelves							1		
Under Sink Cover									1	
Handsoap Dispenser		1	1	1	1	1	1	1		1
Lotion Bottle		1	1	1	1	1	1	1		1
Towel Ring		1	1	1	1	1	1	1		1
Hand Dryer				1	1	1	1	1	1	
Restroom Wall Mirror						1	1			
Shower	Shower Door				1				1	
	Shower Curtain					1	1	1		
	Shower Seat					1	1	1	1	
	Rain Shower			1	1	1	1	1	1	
	Adjustable Shower Head			1	1	1	1	1	1	
	Shower Control			1	1	1	1	1	1	
	Shower Drain			1	1	1	1	1	1	
	Shower Exhaust			1	1	1	1	1	1	
	Soap Dish			1	1	1	1	1	1	
	Soap Dispensing Bottles			3	3	3	3	3	3	
Towel Hooks	On Partition Wall	2	1	1		2	1	2		
	Near Shower Door Entrance				2		1	2		
	Inside Shower								2	
	Near Sink/Vanity			2	2					
Towel Rail		1			1	1	1	1		

CONFIDENTIAL — DO NOT DISTRIBUTE

Figure 11-18: Key Features - Sleeper Cabins: Personal Care (continued)

		Roomette	Solo Suite	Club Bedroom	Premium Bedroom	Accessible Twin	Accessible Double	Accessible Premium Bedroom	Sleeper Cabin Showers	Crew Sleeper Cabin
Towel Storage	Standard			1	1	1	1	1		
	High Capacity Bath Towels								1	
	High Capacity Hand Towels								1	
High Capacity Towel Bin									1	
Changing Area									1	
Changing Area Bench									1	
Changing Area Mirror									1	
Toilet	Toilet			1	1	1	1	1		
	Toilet Seat			1	1	1	1	1		
	Toilet Flush Mechanism			1	1	1	1	1		
	Toilet Paper Dispenser			1	1	1	1	1		
	Toilet Seat Cover Dispenser			1	1	1	1	1		
	Shower Seat Cover			1						
Baby Changing Table						1	1	1		
Seating Area Vanity					1			1		
Premium Restroom Mirror					1					
Full Length Mirror					1	1	1	1		

Figure 11-19: Key Features - Sleeper Cabins: Trash

		Roomette	SoloSuite	Club Bedroom	Premium Bedroom	Accessible Twin	Accessible Double	Accessible Premium Bedroom	Sleeper Cabin Showers	Crew Sleeper Cabin
Passengers (maximum)		2	1	4	2	2	2	4		1
Trash Bin	Seating Area	1	1			1	1	1		1
	Drink Station				1					
	Restroom			1	1	1	1	1		
	Sleeper Cabin Showers								1	
Sanitary Waste Bin					1	1	1	1		
Sharps Bin					1	1	1	1		

Figure 11-20: Key Features - Sleeper Cabins: Storage

		Roomette	SoloSuite	Club Bedroom	Premium Bedroom	Accessible Twin	Accessible Double	Accessible Premium Bedroom	Sleeper Cabin Showers	Crew Sleeper Cabin
Passengers (maximum)		2	1	4	2	2	2	4		1
Cabinet	Cabinet	1		1			1			
	Open Cabinet				1					
	Upper Cabinet					1		2		
	Lower Cabinet					1		1		
Wardrobe	Wardrobe				1					1
	Open Wardrobe			1		1	1	1		
	Crew Sleeper Cabin Wardrobe									1
Coat Hooks		2	2	2	2	2	2	4	2	1
Carryon Luggage Storage		1	1	1	1	1	1	1		1
Under-Seat Storage		1	1	1		1	1	1		1
Seat Shelf						1	1	1		
Cubby	Upper Cubby	2		2		1		2		
	Seat Cubby						1	2		
	Sidewall Cubby		1	2		1	1	2		1
	Bedside Cubby				2					
High Storage Shelf						1	1	2		
Crew Storage	Seating Area Crew Storage				1		1			
	Restroom Crew Storage					1		2	1	
Safe Storage					1					
Linen Cabinet										1
Jacket Closet										1
Clothing Cabinet										1
Drawers										1

CONFIDENTIAL — DO NOT DISTRIBUTE

11.48 Roomette

a). General

- i). The roomette provides comfortable daytime seating and night sleeping accommodations for up to two passengers.
- ii). In the roomette, two seats face each other and share a window view (see Figure 11-66 on page 11-325).
- iii). These seats adjust to create a sleeping area for one passenger and an upper berth can be adjusted in position to create a second sleeping space for another passenger.
- iv). In addition to the seating and sleeping provisions, this accommodation includes a sink.
- v). Please refer to Chapter 1 for information regarding quantity of this accommodation type desired across the trainset and suggested layouts.
- vi). To the extent possible, the Contractor shall adhere to the general arrangement images for Roomette Cabin as shown below.

b). Key Features

- i). A comprehensive list of expected features in the Roomette sleeper cabin is provided in Figure 11-21 and described in detail in the subsequent sections referenced in the table.
- ii). Detailed functional requirements for each feature is listed below.

Figure 11-21: Key Features - Roomette

Feature	Short Description	Qty	Reference	Page
General Items				
Standard Sleeper Cabin Door	24" sliding door that includes window, blind and door lock mechanism. Manual Operation	1	11.58a)	11-201
Side Window	Standardized size with emergency egress features	1	11.58i)	11-206
Side Window Blinds	Light filtering and black out blinds	2	11.58j)	11-206
Outlets	Duplex outlets with USB See Figure 11-68 on page 11-327 for outlet locations.	Figure 11-29	11.58o)	11-208
Master Light Switch	Light switch that can turn on or off all lights in a sleeper room	2	11.58p)	11-209
Master Control Screen	Touchscreen tablet for controlling room environment and opting into train experience features	1	11.58q)	11-209
Master Thermostat Control	Mechanical Interface control of temperature settings	1	11.58r)	11-209
Floor Heat	Heating mechanism for room	1	11.58s)	11-209
Communications				
Digital Displays	Digital display monitor	Figure 11-4	11.25	11-26
Attendant Call Button	LED Button to page Crew	1		
Seating Area / Lower Sleeping Berth				
Standard Sleeper Cabin Seats	Standard Sleeper Cabin Seat includes fold down features to convert into bed	2	11.60a)	11-211
Standard Sleeper Cabin Armrest	Standard Sleeper Cabin Armrest built into sidewall	2	11.60d)	11-216
Standard Sleeper Cabin Headboard	Standard Sleeper Cabin includes a firmly cushioned panel behind the seat that serves as a headboard in the berth configuration.	2	11.60f)	11-217
Cup Holder	Cupholders built into side wall	2	11.60l)	11-218
Single Leaf Fold Out Table	Table built into side wall	1	11.60n)	11-219

Figure 11-21: Key Features - Roomette (continued)

Feature	Short Description	Qty	Reference	Page
Upper Sleeping Berth				
Upper Berth	High level sleeping location with retaining straps	1	11.61a)	11-220
Upper Berth Grab Bar	Grab bar secured to upper berth module.	1	11.61b)	11-221
Upper Berth Steps	Built-in Steps in the upper berth module	1	11.61c)	11-222
Personal Care				
Fold Out Sink	Includes sink basin, faucet, sink open indicator light, and 120 V outlet.	1	11.62b)	11-223
Standard Sink Vanity Cabinet	Small storage cabinet above the sink, with a mirror on the front.	1	11.62d)	11-225
Sink Vanity Mirror	Mirror with boarded LED light or backlight	1	11.62f)	11-226
Handsoap Dispenser	Base for handsoap installed adjacent to the over-sink mirror.	1	11.62j)	11-228
Lotion Bottle	Lotion bottle next to sink	1	11.62k)	11-228
Towel Ring	Install near sink.	1	11.62l)	11-228
Towel Hook	Two on the partition wall.	2	11.62y)	11-231
Towel Rail	Rail for hanging towels to dry	1	11.62z)	11-231
Trash				
Seating Area Trash Bin	Tip out small storage for sleeper room trash	1	11.63a)	11-237
Storage				
Cabinet	Storage location with a door	1	11.64a)	11-238
Coat Hooks	Installed on partition wall.	2	11.64h)	11-241
Carryon Luggage Storage	Storage cubby for carryon sized luggage	1	11.64i)	11-241
Under-Seat Storage	Open space for carryon sized luggage	1	11.64j)	11-242
Upper Cubby	Cubby adjacent to upper berth with outlet and ambient lighting	2	11.64l)	11-243

c). Functional Elements

i). Seat to Lower Berth Conversion

- (1) A simple unlatch mechanism is required to convert the seats into a lower bed/berth.
- (2) This should be positioned in a place that is easy for people to use and designed in a way so that people can understand its purpose.
- (3) The latch should be free for jamming and free from any finger trap hazards.
- (4) Conversion of seats to lower berth shall result in an entirely flat sleeping surface.
- (5) The mattress surface should be integral to the back of the seat.
- (6) A single seam between the bed surface is acceptable with a single thin topper to finish the bed surface.
- (7) There shall be no movement in the lower berth structure under full loading conditions when the lower berth is deployed.
- (8) Lower Berth Dimensions: Minimum width 27" x Minimum length 77"

ii). Deploying Upper Berth

- (1) The upper berth should be stored horizontally at the maximum height in the room.
- (2) When stored, the upper berth should not block any part of the window or window removal in the event of an emergency.
- (3) Leading edges should be soft in form to minimize impact to any potential head strike.
- (4) The berth's stored height should be maximized so head clearance is at a maximum in both seated and standing positions.
- (5) A simple and easy to use handle, latch, and lock mechanism should be within easy reach from a standing position.
- (6) Successful locking should be visually indicated, and safety measures should be put in place to prevent accidental deployment and prevent misuse.
- (7) The upper berth deployment should lower slowly and in a controlled manner.
- (8) Considerations should be made for assisted movement or counterbalances to assist people moving the upper berth down and back up into the stowed position.

- (9) Mitigation should be made to avoid finger traps across any mechanism, rails, or support structures.
 - (10) Upper Berth Dimensions: Minimum width 27" x Minimum length 77"
- d). Lighting
- i). General
 - (1) Lighting general information is shared in the points below.
 - (2) Approximate lighting locations and types are shown in the following Figures:
 - (a) Figure 11-69: Roomette Wash Light Locations
 - (b) Figure 11-70: Roomette Spot Light Locations
 - (c) Figure 11-71: Roomette Compartment Light Locations
 - (d) Figure 11-72: Roomette Reading Light Locations
 - ii). Wash Lights (RGB Lights)
 - (1) Wall Wash Lights
 - (a) Wall wash lights for the aisle partition wall and the back walls behind the seats shall be provided along the length of each wall.
 - (2) Ceiling Wash Lights
 - (a) Ceiling wash lights shall run the length of the room along the window line.
 - (b) This light shall function to illuminate the underside of the upper berth when stored and to illuminate the ceiling when the upper berth is deployed.
 - (3) See Figure 11-69 on page 11-328.
 - iii). LED Panel Spot Lights (White Lights)
 - (1) Two small circular LED light panels shall act as spot lights above the steps to the upper berth (see Figure 11-70 on page 11-329).
 - (2) The frame for the spot lights shall be color matched to the ceiling.
 - iv). Compartment Lights (RGB Lights)
 - (1) Lower Cubby Lights
 - (a) Lower Cubby shall have a strip of indirect lighting to illuminate this cubby and the inside of the luggage storage area.

- (2) Step Light
 - (a) Step shall have a strip of indirect lighting so that the entire lower step is illuminated.
 - (3) Upper Cubby Lights
 - (a) Upper Cubbies shall both be lit with indirect lighting and shall allow the entire cubby to act as indirect lighting for the room as well.
 - (4) Under Seat Lights
 - (a) Under Seat lights shall be provided as indirect lighting that spills out across the floor under the seat.
 - (5) Sink Light
 - (a) A wash light should be used to light the sink area that is automatically activated when the sink is deployed
 - (6) Vanity Light
 - (a) Vanity shall include an internal light source that activates when the door is opened.
 - (7) See Figure 11-71 on page 11-330.
- v). Reading Lights (White Lights)
- (1) Upper Reading Lights
 - (a) Upper reading lights shall be embedded into the ceiling panel above the upper berth.
 - (b) These should be two mini panel lights with one light at each end of the bed. Reading light switches should be located next to the reading light.
 - (2) Lower Reading Lights
 - (a) Lower reading lights shall be provided at each seated position.
 - (b) The light itself shall be adjustable so that the passenger can adjust the direction to position the light over their reading material.
 - (3) Reading Light Switches
 - (a) Reading light switches should be located next to the reading light.
 - (4) See Figure 11-72 on page 11-331.

11.49 SoloSuite

a). General

- i). The SoloSuite (see in Figure 11-73 on page 11-332) is a unique, single passenger compartment that provides enhanced comforts over the roomette.
- ii). The SoloSuite includes a seat that converts to a sleeping berth and a working table on the opposing side.
- iii). A padded footrest lies under the opposing side that is offset to allow the nesting feature to work with the opposite SoloSuite compartment.
- iv). When the seat is converted to 'bed mode', the footrest forms the foot end of the bed.
- v). A mirror image SoloSuite is installed adjacent to the SoloSuite compartment.
- vi). An additional feature of the SoloSuite compartments shall be the ability to combine two of the SoloSuites for face-to-face discussions but can then be closed for privacy and sleeping privately.
- vii). The dividing panels shall be easily opened and stored when the two compartments are twinned but can easily be closed and locked when privacy is desired.
- viii). The partition panel shall be attached in a way that prevents one passenger from being able to remove it without the opposing passenger's permission.
- ix). Please refer to Chapter 1 for information regarding quantity of this accommodation type desired across the trainset and suggested layouts.
- x). To the extent possible, the Contractor shall adhere to the general arrangement images for SoloSuite as shown in Figure 11-73 on page 11-332.

b). Key Features

- i). A comprehensive list of expected features in the SoloSuite is provided in Figure 11-22 and described in detail in the subsequent sections referenced in the table.
- ii). Detailed functional requirements for each feature is listed below.

Figure 11-22: Key Features - SoloSuite

Feature	Short Description	Qty	Reference	Page
General Items				
Standard Sleeper Cabin Door	24" sliding door that includes window, blind and door lock mechanism. Manual Operation.	1	11.58a)	11-201
Side Window	Includes emergency egress features	1	11.58i)	11-206
Side Window Blinds	Light filtering and black out blind	2	11.58j)	11-206
Skylight Window	Window mounted on ceiling	1	11.58k)	11-206
Skylight Window Blinds	Automated blinds for skylight	2	11.58l)	11-207
SoloSuite Room Divider	Retractable dividing partition that is lockable between SoloSuites	1	11.58m)	11-207
SoloSuite Central Console	Divider wall between SoloSuite compartments	1	11.58n)	11-207
Outlets	Duplex outlet with USB. See Figure 11-75 on page 11-334 for outlet locations.	Figure 11-29	11.58o)	11-208
Master Light Switch	Light switch that can turn on or off all lights in a sleeper room	1	11.58p)	11-209
Master Control Screen	Touchscreen tablet for controlling room environment and opting into train experience features	1	11.58q)	11-209
Master Thermostat Control	Mechanical Interface control of temperature settings	1	11.58r)	11-209
Floor Heat	Heating mechanism for room	1	11.58s)	11-209
Standard Grab Bar	49 CFR 38.115 compliant handrails	As needed	11.58t)	11-210
Communications				
Digital Displays	Digital display monitor	Figure 11-4	11.25	11-26
Attendant Call Button	LED Button to page Crew	1	11.59b)	11-210
Seating Area / Lower Sleeping Berth				
Standard Sleeper Cabin Seat	Includes fold down features to convert into bed.	1	11.60a)	11-211
Standard Sleeper Cabin Arm Rest	Built into side of the seat.	2	11.60d)	11-216
Standard Sleeper Cabin Headboard	Standard Sleeper Cabin includes a firmly cushioned panel behind the seat that serves as a headboard in the berth configuration	1	11.60f)	11-217

CONFIDENTIAL — DO NOT DISTRIBUTE

Figure 11-22: Key Features - SoloSuite (continued)

Feature	Short Description	Qty	Reference	Page
SoloSuite Ottoman	Foot rest that converts into portion of bed	1	11.60i)	11-217
SoloSuite Ottoman Table	Table above the ottoman for working	1	11.60j)	11-217
Cup Holder	Cupholders built into side wall	1	11.60l)	11-218
Bottle Holder	Small storage location in carshell side wall	1	11.60m)	11-218
Single Leaf Fold Out Table	Table built into side wall	1	11.60n)	11-219
Personal Care				
Fold Out Sink	Includes sink basin, faucet, soap dispenser, 120 V outlet, sink open indicator light, towel ring, and lotion bottle	1	11.62b)	11-223
Standard Sink Vanity Cabinet	Small storage cabinet above the sink, with a mirror on the front.	1	11.62d)	11-225
Sink Vanity Mirror	Mirror with boarder LED light or backlight	1	11.62f)	11-226
Handsoap Dispenser	Base for handsoap installed adjacent to the over-sink mirror.	1	11.62j)	11-228
Lotion Bottle	Lotion bottle next to sink	1	11.62k)	11-228
Towel Ring	Install near sink.	1	11.62l)	11-228
Towel Hook	Installed on partition wall	1	11.62y)	11-231
Trash				
Seating Area Trash Bin	Flip out storage for sleeper room trash	1	11.63a)	11-237
Storage				
Coat Hooks	Installed on partition wall	2	11.64h)	11-241
Carryon Luggage Storage	Storage cubby for carryon sized luggage	1	11.64i)	11-241
Under Seat Storage	Open space for carryon sized luggage	1	11.64j)	11-242
Sidewall Cubby	Storage location in carshell side wall	1	11.64n)	11-243

c). Functional Elements

i). Seat to Berth Conversion

- (1) A simple unlatch mechanism is required to convert the seat into a bed/berth.
- (2) This should be positioned in a place that is easy for people to use and designed in a way so that people can understand its purpose.
- (3) The latch should be free for jamming and free from any finger trap hazards.
- (4) Conversion of seat to berth shall result in an entirely flat sleeping surface.
- (5) The mattress surface should be integral to the back of the seat.
- (6) A single seam between the bed surface is acceptable with a single thin topper will finish the bed surface.
- (7) There shall be no movement in the berth structure under full loading conditions when the berth is deployed.
- (8) A folding ottoman pad should complete the seat surface between bed and ottoman.
- (9) The pad should be independently operated.
- (10) Care should be taken in the design and activation to avoid accidental entrapment or mitigate injury through misuse.
- (11) The folding ottoman pad and ottoman table leaf should create a space large enough for a passenger to stand and deploy and stow the bed while in the room with the door closed.
- (12) Lower Berth Dimensions:
 - (a) There should be a minimum of 82" between the two opposite corners account for the tapering bed shape.
 - (b) There should be a minimum of 22" between the inside surface of the footbox and any sidewall structure.
 - (c) There should be a minimum of 77" bed length.
 - (d) There should be a minimum of 34" bed width.
 - (e) Dimensions and usability will be subject to Amtrak approval at the mockup review.

- ii). Opening Room Divider
 - (1) As the divider is deployed it must be done with a smooth and gliding motion, with little or no noise.
 - (2) The deployment of the divider should be easy to use and be able to be operate safely by passengers independently.
 - (3) There should be no finger traps or hazards.
 - (4) When the divider is in its closed position it must provide good sound insulation to the adjoining room and noise levels from the adjoining rooms shall be less than or equal to 65 dBA.
 - (5) When closed, the divider must be free from rattle and movement and be securely locked in place along all edges.
 - (6) There should be no light spill from the adjoining room.
 - (7) The divider shall be installed so that damage from pushing the divider off track and into an opposing SoloSuite is prevented.

- d). Lighting
 - i). General
 - (1) Lighting general information is shared in the points below.
 - (2) Approximate lighting locations and types are shown in the following Figures:
 - (a) Figure 11-76: SoloSuite Wash Light Locations
 - (b) Figure 11-77: SoloSuite Spot Light Locations
 - (c) Figure 11-78: SoloSuite Compartment Light Locations
 - (d) Figure 11-79: SoloSuite Reading Light Locations

 - ii). Wash Lights (RGB Lights)
 - (1) Wall Wash Lights
 - (a) Wall wash lights for the aisle partition wall and the back wall behind the seat shall be provided along the length of each wall.

 - (2) Ceiling Wash Lights
 - (a) Ceiling wash lights shall run the length of the room along the window line.
 - (b) This light shall function to illuminate the ceiling where the skylight is located when the skylight blind is deployed.

- (3) Divider Wash Lights
 - (a) Divider wash light shall run the length of the divider wall and illuminate the area where the divider is located and the table space below it.
- (4) See Figure 11-76 on page 11-335.
- iii). LED Panel Spot Lights (White Lights)
 - (1) Two small circular LED light panels shall act as spot lights above the entry door (see Figure 11-77 on page 11-336).
 - (2) The frame for the spot lights shall be color matched to the ceiling.
- iv). Compartment Light (RGB Lights)
 - (1) Armrest Cubby Lights
 - (a) Armrest cubbies shall have a strip of indirect lighting to illuminate each cubby.
 - (2) Bottle Storage Cubby Lights
 - (a) Bottle storage cubby shall have a strip of indirect lighting to illuminate this cubby.
 - (3) Ottoman Lower Cubby and Footbox Lights
 - (a) Ottoman area lower cubby and footbox shall both be lit with indirect lighting and shall allow the entire cubby to act as indirect lighting for the room as well.
 - (4) Under Seat Lights
 - (a) Under Seat lights shall be provided as indirect lighting that spills out across the floor under the seat.
 - (5) Sink Light
 - (a) A wash light should be used to light the sink area that is automatically activated when the sink is deployed
 - (6) Vanity Light
 - (a) Vanity shall include an internal light source that activates when the door is opened.
 - (7) See Figure 11-78 on page 11-337.
- v). Reading Lights (White Lights)
 - (1) Lower Reading Lights

- (a) Lower reading lights shall be provided at each seated position.
 - (b) The light itself shall be adjustable so that the passenger can adjust the direction to position the light over their reading material.
 - (2) Reading Light Switches
 - (a) Reading light switches should be located next to the reading light.
 - (3) Corner Lamp
 - (a) A corner lamp shall wash indirect light both up and down. The switch for this light shall be located next to the lamp.
 - (4) See Figure 11-79 on page 11-338.
- e). Security
 - i). Many items within the sleeper cabin area will need to be secured. Unique items for this sleeper cabin type are defined below.
 - (1) Divider Locking Mechanism
 - (a) The divider shall be able to be locked by the passenger occupying one of the SoloSuite compartments.
 - (b) The divider locking mechanism shall be tamper proof from the adjoining SoloSuite side and shall provide the passenger with confidence that their privacy and personal space will be maintained when they have locked their side of the divider.
 - (c) The divider lock shall have a clear indication of the locked or unlock status of the mechanism.

11.50 Club Bedroom

a). General

- i). The Club Bedroom (see Figure 11-80 on page 11-339) provides comfortable daytime seating and night sleeping accommodations for up to four passengers.
- ii). In the Club Bedroom, two double seats face each other and share a window view.
- iii). These seats adjust to create a sleeping area for two passengers to share a sleeping space and an upper berth can be adjusted in position to create a second sleeping space for two additional passengers.
- iv). In addition to the seating and sleeping provisions, this accommodation includes a small restroom with a shower and sink area.
- v). Entry into the Club Bedroom is through the sink and shower area.
- vi). Please refer to Chapter 1 for information regarding quantity of this accommodation type desired across the trainset and suggested layouts.
- vii). To the extent possible, the Contractor shall adhere to the general arrangement images for the Club Bedroom as shown below.

b). Key Features

- i). A comprehensive list of expected features in this type of sleeper cabin is provided in Figure 11-23 and described in detail in the subsequent sections referenced in the table.
- ii). Detailed functional requirements for each feature is listed below.

Figure 11-23: Key Features - Club Bedroom

Feature	Short Description	Qty	Reference	Page
General Items				
Standard Sleeper Cabin Door	24" sliding door that includes window, blind and door lock mechanism. Manual operation.	1	11.58a)	11-201
Standard Sleeper Cabin Restroom Door	Bifold door for entrance into restroom	1	11.58d)	11-203
Side Window	Includes emergency egress features	1	11.58i)	11-206
Side Window Blinds	Light filtering and black out blind	2	11.58j)	11-206
Outlets	Duplex outlet with USB. See Figure 11-82 on page 11-341 for outlet locations.	Figure 11-29	11.58o)	11-208
Master Light Switch	Light switch that can turn on or off all lights in a sleeper room	2	11.58p)	11-209
Master Control Screen	Touchscreen tablet for controlling room environment and opting into train experience features	1	11.58q)	11-209
Master Thermostat Control	Mechanical Interface control of temperature settings	1	11.58r)	11-209
Floor Heat	Heating mechanism for room	1	11.58s)	11-209
Standard Grab Bars	49 CFR 38.115 compliant handrails	As needed	11.58t)	11-210
Restroom Grab bars	49 CFR 38.123 compliant handrails	As needed	11.58u)	11-210
Communications				
Digital Displays	Digital display monitor	Figure 11-4	11.25	11-26
Attendant Call Button	LED Button to page Crew	1	11.59b)	11-210
Seating Area / Lower Sleeping Berth				
Standard Sleeper Cabin Seat	Includes fold down features to convert into bed	4	11.60a)	11-211
Standard Sleeper Cabin Arm Rest	Built into sidewall	2	11.60d)	11-216
Standard Sleeper Cabin Headboard	Includes a firmly cushioned panel behind the seat that serves as a headboard in the berth configuration	2	11.60f)	11-217

CONFIDENTIAL — DO NOT DISTRIBUTE

Figure 11-23: Key Features - Club Bedroom (continued)

Feature	Short Description	Qty	Reference	Page
Cup Holder	Cupholders built into side wall	2	11.60l)	11-218
Bottle Holder	Small storage location in carshell side wall	2	11.60m)	11-218
Single Leaf Fold Out Table	Table built into side wall	1	11.60n)	11-219
Upper Sleeping Berth				
Upper Berth	High level sleeping location with retaining straps	1	11.61a)	11-220
Upper Berth Grab Bar	49 CFR 38.115 compliant handrails	2	11.61b)	11-221
Upper Berth Steps	Rigid structure dual purpose for storage and steps	1	11.61c)	11-222
Personal Care				
Solid Surface Sink	Includes sink basin, faucet, soap dispenser, 120 V outlet, towel ring, and lotion bottle	1	11.62c)	11-224
Standard Sink Vanity Cabinet	Small storage cabinet above the sink, with a mirror on the front.	1	11.62d)	11-225
Sink Vanity Mirror	Mirror with boarder LED light or backlight	1	11.62f)	11-226
Handsoap Dispenser	Base for handsoap installed adjacent to the over-sink mirror.	1	11.62j)	11-228
Lotion Bottle	Lotion bottle next to sink	1	11.62k)	11-228
Towel Ring	Install near sink.	1	11.62l)	11-228
Hand Dryer	Automatic hand dryer	1	11.62m)	11-228
Rain Shower	Shower head mounted on the ceiling	1	11.62r)	11-229
Adjustable Shower Head	Handheld shower head	1	11.62s)	11-230
Shower Control	Adjustment for water pressure and temperature in the shower	1	11.62t)	11-230
Shower Drain	Drain location for shower	1	11.62u)	11-230
Shower Exhaust	Adjustable exhaust grille	1	11.62v)	11-230
Soap Dish	Storage location for personal soap items in shower	1	11.62w)	11-231
Soap Dispensing Bottles	Refillable soap, conditioner, and lotion bottles mounted on wall	3	11.62x)	11-231
Towel Hook	Installed on partition wall	1	11.62y)	11-231
Towel Hook	Install near vanity	2	11.62y)	11-231

CONFIDENTIAL — DO NOT DISTRIBUTE

Figure 11-23: Key Features - Club Bedroom (continued)

Feature	Short Description	Qty	Reference	Page
Standard Towel Storage	Elevated towel rack	1	11.62aa)	11-231
Toilet	Assembly including toilet bowl, shroud, and overflow pan	1	11.62hh)	11-233
Toilet Seat	Assembly including lid and seat for toilet	1	11.62ii)	11-234
Toilet Flush Mechanism	Push button flush and automatic flush mechanisms	1	11.62jj)	11-234
Toilet Paper Dispenser	Protective location for dispensing toilet paper	1	11.62kk)	11-234
Toilet Seat Cover Dispenser	Protective location for dispensing toilet seat covers	1	11.62ll)	11-235
Shower Seat Cover	Additional cover for toilet that converts toilet area into shower seat	1	11.62mm)	11-235
Trash				
Restroom Trash	Trash bin built into sink and vanity area for sleeper bedroom	1	11.63c)	11-237
Storage				
Cabinet	Storage location with a door	1	11.64a)	11-238
Open Wardrobe	Open storage location with coat rod	1	11.64f)	11-240
Coat Hooks	Installed in open wardrobe area	2	11.64h)	11-241
Carryon Luggage Storage	Storage cubby for carryon sized luggage	1	11.64i)	11-241
Under Seat Storage	Open space for carryon sized luggage	1	11.64j)	11-242
Upper Cubby	Cubby adjacent to upper berth with outlet and ambient lighting	2	11.64l)	11-243
Sidewall Cubby	Storage location in carshell side wall	2	11.64n)	11-243

c). Functional Elements

i). Seat to Lower Berth Conversion

- (1) A simple unlatch mechanism is required to convert the seats into a lower bed/berth.
- (2) This should be positioned in a place that is easy for people to use and designed in a way so that people can understand its purpose.
- (3) The latch should be free for jamming and free from any finger trap hazards.
- (4) Conversion of seats to lower berth shall result in an entirely flat sleeping surface.
- (5) The mattress surface should be integral to the back of the seat.
- (6) A single seam between the bed surface is acceptable with a single thin topper will finish the bed surface.
- (7) There shall be no movement in the lower berth structure under full loading conditions when the lower berth is deployed.
- (8) Lower Berth Dimensions: Minimum width 48" x Minimum length 77"

ii). Deploying Upper Berth

- (1) The upper berth should be stored horizontally at the maximum height in the room.
- (2) When stowed, the upper berth should not block any part of the window or window removal in the event of an emergency.
- (3) Leading edges should be soft in form to minimize impact to any potential head strike.
- (4) The berth's stored height should be maximized so head clearance is at a maximum in both seated and standing positions.
- (5) A simple and easy to use handle, latch, and lock mechanism should be within easy reach from a standing position.
- (6) Successful locking should be visually indicated, and safety measures should be put in place to prevent accidental deployment and prevent misuse.
- (7) The upper berth deployment should be free from jamming and racking and should lower slowly and in a controlled manner.
- (8) Considerations should be made for assisted movement or counterbalances to assist people moving the upper berth down and back up into the stored position.

- (9) Mitigation should be made to avoid finger traps across any mechanism, rails, or support structures.
 - (10) Upper Berth Dimensions: Minimum width 48" x Minimum length 77"
- d). Lighting
- i). General
 - (1) Lighting general information is shared in the points below.
 - (2) Approximate lighting locations and types are shown in the following Figures:
 - (a) Figure 11-83: Club Bedroom Wash Light Locations
 - (b) Figure 11-84: Club Bedroom Spot Light Locations
 - (c) Figure 11-85: Club Bedroom Lobby Light Locations
 - (d) Figure 11-86: Club Bedroom Light Locations
 - (e) Figure 11-87: Club Bedroom Reading Light Locations
 - (f) Figure 11-88: Club Bedroom Restroom Light Locations
 - ii). Wash Lights (RGB Lights)
 - (1) Wall Wash Lights
 - (a) Wall wash lights for the aisle partition wall and the back walls behind the seats shall be provided along the length of each wall.
 - (2) Ceiling Wash Lights
 - (a) Ceiling wash lights shall run the length of the room along the window line.
 - (b) This light shall function to illuminate the underside of the upper berth when stored and to illuminate the ceiling when the upper berth is deployed.
 - (c) See Figure 11-83 on page 11-342.
 - (3) LED Panel Spot Lights (White Lights)
 - (a) Two small circular LED light panels shall act as spot lights above the steps to the upper berth and above the open wardrobe (see Figure 11-84 on page 11-343).
 - (b) The frame for the spot lights shall be color matched to the ceiling.
 - (4) Lobby Lighting (White Lights)

- (a) Indirect wall washing light created from ring lighting that provides light to the lobby and vanity area of the Club Bedroom. (see Figure 11-85 on page 11-344)
 - (b) Central LED panel spot light that provides light to the lobby and vanity area of the Club Bedroom.
- iii). Compartment Light (RGB Lights)
 - (1) Step Lights
 - (a) Step shall have a strip of indirect lighting so that the entire lower step is illuminated.
 - (2) Upper Cubby Lights
 - (a) Upper Cubbies shall both be lit with indirect lighting and shall allow the entire cubby to act as indirect lighting for the room as well.
 - (3) Under Seat Lights
 - (a) Under seat lights shall be provided as indirect lighting that spills out across the floor under the seat.
 - (4) Sink Light
 - (a) A wash light should be used to light the sink area
 - (5) Vanity Light
 - (a) Vanity shall include an internal light source that activates when the door is opened.
 - (6) Mirror Light
 - (a) A round LED light shall illuminate the mirror around the boarder.
 - (7) See Figure 11-86 on page 11-345.
- iv). Reading Lights (White Lights)
 - (1) Upper Reading Lights
 - (a) Upper reading lights shall be embedded into the ceiling panel above the upper berth.
 - (b) These should be four mini panel lights with two lights at each end of the bed.
 - (c) Reading light switches should be located next to the reading light.

- (2) Lower Reading Lights
 - (a) Lower reading lights shall be provided at each seated position.
 - (b) The light itself shall be adjustable so that the passenger can adjust the direction to position the light over their reading material.
 - (c) Reading light switches should be located next to the reading light.
 - (d) See Figure 11-87 on page 11-346.
- v). Restroom Lighting (RGB Lights)
 - (1) Ring Wash Light
 - (a) A ring wash light shall be provided in the ceiling and shall be activated by the preset lighting condition controlled by the master switch.
 - (b) This light shall illuminate the walls of the restroom indirectly.
 - (2) Back Wall Wash Light
 - (a) A back wall wash light shall be mounted to the towel shelf and provide both up and down wall washing lighting.
 - (b) This shall only activate when the door to the restroom is locked.
 - (3) Spot Light
 - (a) A LED spot light shall be located on the ceiling above the toilet and adjacent to the rain shower.
 - (b) This shall only activate when the door to the restroom is locked. This shall be a white light.
 - (c) See Figure 11-88 on page 11-347.
- e). Security
 - i). Unique items for this sleeper cabin type are defined below.
 - (1) Restroom Door Locking Mechanism
 - (a) This locking mechanism shall indicate to other passengers sharing the room that the restroom is occupied.
 - (b) Additionally, the locking of this door shall activate certain lighting fixtures as explained above.

11.51 Premium Bedroom

a). General

- i). The Premium Bedroom (see Figure 11-89 on page 11-348) is designed to offer a luxurious travel experience allowing a sleeping compartment that is the full width of the train.
- ii). It is a contained room with a queen bed, table with two seats offering face-to-face seating, and a desk.
- iii). The room also has an enclosed shower and toilet. Because of the room's full car width configuration, there are windows on both sides to convey an open environment.
- iv). The Premium Bedroom should be a maximum of 140" long and occupy the full width of a Bi-level car.
- v). Please refer to Chapter 1 for information regarding quantity of this accommodation type desired across the trainset and suggested layouts.
- vi). To the extent possible, the Contractor shall adhere to the general arrangement images for the bedroom cabin as shown below.

b). Key Features

- i). A comprehensive list of expected features in this type of sleeper cabin is provided in Figure 11-24 and described in detail in the subsequent sections referenced in the table.
- ii). Detailed functional requirements for each feature is listed below.

Figure 11-24: Key Features - Premium Bedroom

Feature	Short Description	Qty	Reference	Page
General Items				
Standard Sleeper Cabin Door	24" sliding door that includes window, blind and door lock mechanism. Manual Operation.	1	11.58a)	11-201
Standard Sleeper Cabin Restroom Door	Bifold door for entrance into restroom	1	11.58d)	11-203
Standard Sleeper Cabin Shower Room Door	Bifold door for entrance into shower room	1	11.58g)	11-205
Side Window	Includes emergency egress features	2	11.58i)	11-206
Side Window Blinds	Light filtering and black out blind	4	11.58j)	11-206
Outlets	Duplex outlet with USB. See Figure 11-91 on page 11-350 for outlet locations.	Figure 11-29	11.58o)	11-208
Master Light Switch	Light switch that can turn on or off all lights in a sleeper room	1	11.58p)	11-209
Master Control Screen	Touchscreen tablet for controlling room environment and opting into train experience features	1	11.58q)	11-209
Master Thermostat Control	Mechanical Interface control of temperature settings	1	11.58r)	11-209
Floor Heat	Heating mechanism for room	1	11.58s)	11-209
Standard Grab Bars	49 CFR 38.115 compliant handrails	As needed	11.58t)	11-210
Restroom Grab Bars	49 CFR 38.123 compliant handrails	As needed	11.58u)	11-210
Communications				
Digital Displays	Digital display monitor	Figure 11-4	11.25	11-26
Attendant Call Button	LED Button to page Crew	1	11.59b)	11-210
Attendant Call Button (Waterproof)	Waterproof LED Button to page Crew from toilet room or shower room.	2	11.59b)	11-210
PEI	Speaker for emergency conversations	1	11.59d)	11-211

Figure 11-24: Key Features - Premium Bedroom (continued)

Feature	Short Description	Qty	Reference	Page
Seating Area / Lower Sleeping Berth				
Premium Sleeper Cabin Seat	The seats should rotate to face the aisle between the bed and the window to aid ingress and egress. The seat by the vanity area should rotate 180° to allow passengers to comfortably use the desk/table.	2	11.60b)	11-214
Premium Sleeper Cabin Headboard	A firmly cushioned panel behind the seat that serves as a headboard in the berth configuration.	1	11.60g)	11-217
Adjustable Bed / Lounger	Convertible queen bed to lounger	1	11.60k)	11-218
Cup Holder	Cupholders built into side wall	2	11.60l)	11-218
Single Leaf Fold Out Table	Table built into side wall	1	11.60n)	11-219
Personal Care				
Drink Station	Location with provisions for coffee maker and associated condiments	1	11.62a)	11-223
Solid Surface Sink	Solid surface sink counter and basin	1	11.62c)	11-224
Standard Sink Vanity Cabinet	Storage cabinet in sink area	1	11.62d)	11-225
Sink Vanity Mirror	Mirror with boarder LED light or backlight	1	11.62f)	11-226
Sink Vanity Shelves	Shelves adjacent to sink area	1	11.62g)	11-227
Handsoap Dispenser	Base for handsoap installed adjacent to the over-sink mirror.	1	11.62j)	11-228
Lotion Bottle	Lotion bottle next to sink	1	11.62k)	11-228
Towel Ring	Install near sink.	1	11.62l)	11-228
Hand Dryer	Automatic hand dryer	1	11.62m)	11-228
Shower Door	Bifold safety glass door for entrance into shower	1	11.62o)	11-229
Rain Shower	Shower head mounted on the ceiling	1	11.62r)	11-229
Adjustable Shower Head	Handheld shower head	1	11.62s)	11-230
Shower Control	Adjustment for water pressure and temperature in the shower	1	11.62t)	11-230
Shower Drain	Drain location for shower	1	11.62u)	11-230
Shower Exhaust	Adjustable exhaust grille	1	11.62v)	11-230

CONFIDENTIAL — DO NOT DISTRIBUTE

Figure 11-24: Key Features - Premium Bedroom (continued)

Feature	Short Description	Qty	Reference	Page
Soap Dish	Storage location for personal soap items in shower	1	11.62w)	11-231
Soap Dispensing Bottles	Refillable soap, conditioner, and lotion bottles mounted on wall	3	11.62x)	11-231
Towel Hook	Installed near the entrance to the shower door.	2	11.62y)	11-231
Towel Hook	Installed near sink vanity.	2	11.62y)	11-231
Towel Rail	Rail for folded towel hanging	1	11.62z)	11-231
Standard Towel Storage	Elevated towel rack	1	11.62aa)	11-231
Toilet	Assembly including toilet bowl, shroud, and overflow pan	1	11.62hh)	11-233
Toilet Seat	Assembly including lid and seat for toilet	1	11.62ii)	11-234
Toilet Flush Mechanism	Push button flush and automatic flush mechanisms	1	11.62jj)	11-234
Toilet Paper Dispenser	Protective location for dispensing toilet paper	1	11.62kk)	11-234
Toilet Seat Cover Dispenser	Protective location for dispensing seat covers	1	11.62ll)	11-235
Seating Area Vanity	Unit with a desk, mirror and shelf. Located behind the seat and adjacent to the headboard and bedside cubbies.	1	11.62oo)	11-235
Premium Restroom Mirror	Large mirror opposite the restroom door.	1	11.62pp)	11-236
Full Length Mirror	Long mirror mounted on sidewall of restroom or cabinet	1	11.62qq)	11-236
Trash				
Drink Station Trash Bin	Large trash storage location with trash flaps	1	11.63b)	11-237
Restroom Trash	Storage for restroom related trash	1	11.63c)	11-237
Sanitary Waste	Storage location for used feminine hygiene products	1	11.63e)	11-238
Sharps Bin	Storage location for used needles and other medical waste	1	11.63f)	11-238
Storage				
Open Cabinet	Open storage location	1	11.64b)	11-239
Wardrobe	Storage location with coat rod	1	11.64e)	11-240
Coat Hooks	Installed in open wardrobe area.	2	11.64h)	11-241
Carryon Luggage Storage	Storage cubby for carryon sized luggage	1	11.64i)	11-241
Bedside Cubby	Open storage shelves with outlets	2	11.64o)	11-244

Figure 11-24: Key Features - Premium Bedroom (Continued)

Feature	Short Description	Qty	Reference	Page
Seating Area Crew Storage	Locker with square key for dedicated crew storage	2	11.64q)	11-244
Safe Storage	Hotel style safe	1	11.64s)	11-245

c). Functional Elements

i). Lounger to Bed Conversion

- (1) A simple control is required to convert the lounger into a bed.
- (2) This should be positioned in a place that is easy for people to use and designed in a way so that people can understand its purpose.
- (3) The mechanism should be free from jamming and free from any entrapment hazards.
- (4) Conversion of lounger to bed shall result in an entirely flat sleeping surface.
- (5) There shall be no movement in the bed structure under full loading conditions when the bed is fully deployed.
- (6) Deployed queen bed dimensions: Minimum width 60" x Minimum length 78"
- (7) When the bed is deployed, a free clear channel of at least 15" should be provided on the floor.
- (8) A minimum of 10" is acceptable above 9" from the finish floor.
- (9) Key dimensions and access will be subject to Amtrak approval at the mockup review.

ii). Motorized Bed Conversion (option)

- (1) Conversion of lounger to bed shall be automated and powered.
 - (a) Operation of the bed to lounger shall also be functional in a manual mode so that loss of power or malfunction does not place a room out of service.
- (2) The controller shall report alerts and faults to the car diagnostic system. See Chapter 24 for additional information.

d). Lighting

i). General

- (1) Lighting general information is shared in the points below.
- (2) Approximate lighting locations and types are shown in the following Figures:
 - (a) Figure 11-92: Premium Bedroom Wash Light Locations
 - (b) Figure 11-93: Premium Bedroom Light Locations

- (c) Figure 11-94: Premium Bedroom Reading Light Locations
 - (d) Figure 11-95: Premium Bedroom Ceiling Pool Light Locations
 - (e) Figure 11-96: Premium Bedroom Restroom Light Locations
 - (f) Figure 11-97: Premium Bedroom Shower Light Locations
- ii). Wash Lights in the Premium Bedroom (RGB Lights)
- (1) Wall wash lights for both carshell walls shall be provided along the length of each wall above the windows and shall illuminate the sidewall and blinds.
 - (2) Low wall wash lights for both carshell walls shall be provided along the length of each wall below the windows.
 - (3) Ceiling coving wash lights shall run the length of the room along the window line.
 - (4) Entrance wash light shall be projected across the entrance hall ceiling.
 - (5) See Figure 11-92 on page 11-351.
- iii). Compartment Light in the Premium Bedroom - RGB Lights
- (1) Under Bed Lights
 - (a) Under bed lights shall be provided as indirect lighting that spills out across the floor under the seat.
 - (2) Upper Vanity Lights
 - (a) Upper Vanity shall be lit with indirect lighting and shall allow the entire vanity alcove to be illuminated.
 - (3) Lower Vanity Lights
 - (a) Lower Vanity shall be lit with indirect lighting and shall allow the entire vanity alcove to be illuminated.
 - (4) Shelf Lights
 - (a) Each shelf shall have an indirect strip light that washes from the underside of each shelf above. This includes all storage cubby shelves.
 - (5) Cabinet Lights
 - (a) Cabinets shall include an internal light source that activates when the door is opened.
 - (b) This includes the luggage and wardrobe cabinets.

- (6) Mirror Light
 - (a) A round LED light shall illuminate the mirror around the boarder at the vanity location.
 - (b) See Figure 11-93 on page 11-352.
- (7) Reading Light in the Premium Bedroom (White Lights)
 - (a) Lower Reading Lights
 - (i) Lower reading lights shall be provided on either side of the bed.
 - (ii) The light itself shall be adjustable so that the passenger can adjust the direction to position the light over their reading material.
 - (iii) Reading light switches should be located next to the reading light.
 - (b) Corner Lamp
 - (i) A corner lamp shall wash indirect light both up and down.
 - (ii) The switch for this light shall be located next to the lamp.
 - (iii) The lamps shall be located on either side of the bed.
 - (iv) See Figure 11-94 on page 11-353.
- (8) Ceiling Lighting in the Premium Bedroom (White Light)
 - (a) A feature pool light shall be central to the ceiling. (see Figure 11-95 on page 11-354)
 - (b) This shall provide indirect wall washing across the ceiling at the center of the room.
- (9) Wash Lights in the Premium Restroom (RGB Lights)
 - (a) Ceiling coving wash lights shall run the length of backwall and upwards onto the ceiling.
 - (b) This light shall be activated as a preset on the master switch.
 - (c) Backsplash wash light shall be mounted above the sink under the vanity storage and shall wash indirect light onto the sink surface.
 - (d) This shall be activated only when the restroom door is locked.

- (e) Back wall wash light shall be mounted to the bottom of the mirror above the toilet and shall provide indirect wash lighting downward.
 - (f) Floor wash light shall be mounted to the lower sidewall panels and provide indirect light onto the floor.
 - (g) This light shall be activated as a preset on the master switch.
- (10) LED Panel Spot Lights in the Premium Restroom (White Lights)
- (a) One large circular LED light panel shall act as a spot light above the center of the restroom that activates when the door is locked.
 - (b) The frame for the spot lights shall be color matched to the ceiling.
- (11) Compartment Light in the Premium Restroom (RGB Lights)
- (a) Mirror
 - (i) A rounded LED light shall illuminate the mirror around the boarder at the vanity location.
 - (ii) This shall be activated by a separate switch near the mirror.
 - (b) Vanity Cabinet Lights
 - (i) Vanity cabinets shall include an internal light source that activates when the door is opened.
 - (c) Vanity Shelf Light
 - (i) Each shelf shall have an indirect strip light that washes from the underside of each shelf above.
 - (ii) See Figure 11-96 on page 11-355.
- (12) Wash Lights in the Premium Bedroom Shower (RGB Lights)
- (a) Side Wall Wash Lights
 - (i) Side wall wash lights shall be mounted to the sidewalls near the ceiling at the entrance to the shower and shall provide indirect wash lighting downward.
 - (b) Ring Wash Light
 - (i) A ring wash light shall be mounted to the ceiling and cast indirect light around the sides of the shower compartment.

- (ii) This light shall be activated as a preset on the master switch.
 - (iii) See Figure 11-97 on page 11-356.
 - (13) LED Panel Spot Lights in the Premium Bedroom - White Lights
 - (a) Two small circular LED light panels shall act as spot lights above the entrance hallway.
 - (b) The frame for the spot lights shall be color matched to the ceiling.
- e). Security
 - i). Many items within the sleeper cabin area will need to be secured.
 - ii). Unique items for this sleeper cabin type are defined below.
 - (1) Shower Door Locking Mechanism
 - (a) This locking mechanism shall indicate to other passengers sharing the room that the shower is occupied.
 - (b) Additionally, the locking of this door shall activate certain lighting fixtures as explained above.
 - (2) Restroom Door Locking Mechanism
 - (a) This locking mechanism shall indicate to other passengers sharing the room that the restroom is occupied.
 - (b) Additionally, the locking of this door shall activate certain lighting fixtures as explained above.
 - (3) Safe Locking Mechanism
 - (a) The safe shall have an integrated locking mechanism with a reprogrammable code that can be set by the passenger.

11.52 Accessible Twin

- a). General
 - i). The Accessible Twin is a fully accessible room for two.
 - ii). The room has a single lower berth and a single upper berth.
 - iii). The accessible space is based on the RVACC recommendations to accommodate larger mobility devices.
 - iv). The ability to turn around in the room is facilitated by a clear 60" turning circle in day and nighttime conditions.
 - v). The room has an ensuite restroom that is also fully accessible with a lockable door separating it from the living space.
 - vi). The Accessible Twin should be a maximum of 162" long and designed for a 32" side aisle.
 - vii). The restroom module should be the same across both the Accessible Double and the Accessible Twin.
 - viii). All features shall be reached by a person sitting in a wheeled mobility device unless otherwise listed in this section.
 - ix). Dimensions and anthropomorphic data shall be taken from the Americans with Disabilities Act.
 - x). Please refer to Chapter 1 for information regarding quantity of this accommodation type desired across the trainset and suggested layouts.
 - xi). To the extent possible, the Contractor shall adhere to the general arrangement images for the Accessible Twin cabin as shown in Figure 11-98 on page 11-357.
- b). Key Features
 - i). A comprehensive list of expected features in the Accessible Twin sleeper cabin is provided in Figure 11-25 and described in detail in the subsequent sections referenced in the table.
 - ii). Detailed functional requirements for each feature is listed below.

Figure 11-25: Key Features - Accessible Twin

Feature	Short Description	Qty	Reference	Page
General Items				
Accessible Sleeper Cabin Door	39" sliding door that includes window, blind and door lock mechanism. Automatic Operation.	1	11.58b)	11-202
Accessible Sleeper Cabin Door Controls	ADA accessible controls for operating doors	2	11.58c)	11-202
Accessible Sleeper Cabin Restroom Door	36" sliding two panel automatic door for accessible sleeper restroom.	1	11.58e)	11-204
Accessible Sleeper Cabin Restroom Door Controls	Button activated operator.	2	11.58f)	11-205
Side Window	Includes emergency egress features	1	11.58i)	11-206
Side Window Blinds	Light filtering and black out blind	2	11.58j)	11-206
Outlets	Duplex outlet with USB. See Figure 11-100 on page 11-359 for outlet locations.	Figure 11-29	11.58o)	11-208
Master Light Switch	Light switch that can turn on or off all lights in a sleeper room	2	11.58p)	11-209
Master Control Screen	Touchscreen tablet for controlling room environment and opting into train experience features	1	11.58q)	11-209
Master Thermostat Control	Mechanical Interface control of temperature settings	1	11.58r)	11-209
Floor Heat	Heating mechanism for room	1	11.58s)	11-209
Standard Grab Bars	49 CFR 38.115 compliant handrails	As needed	11.58t)	11-210
Restroom Grab Bars	49 CFR 38.123 compliant handrails	As needed	11.58u)	11-210
Communications				
Digital Displays	Digital display monitor	Figure 11-4	11.25	11-26
Passenger Information Screen	Space should be provided for an additional passenger information screen in all accessible rooms (PIS/OTIS)	1	11.59a)	11-210
Attendant Call Button	LED Button to page Crew	1	11.59b)	11-210
Emergency Call Button	Buttons in accessible locations that activate PEI	2	11.59b)	11-210
PEI - Intercom only	Speaker for emergency conversations	1	11.59d)	11-211

CONFIDENTIAL — DO NOT DISTRIBUTE

Figure 11-25: Key Features - Accessible Twin (continued)

Feature	Short Description	Qty	Reference	Page
Seating Area / Lower Sleeping Berth				
Standard Sleeper Cabin Seat	Standard Sleeper Cabin Seat includes fold down features to convert into bed	2	11.60a)	11-211
Tip Up Seat	Wall mounted seat that can fold away when not in use	1	11.60c)	11-216
Standard Sleeper Cabin Armrest	Standard Sleeper Cabin Armrest built into sidewall.	2	11.60d)	11-216
Center Armrest	Center armrest between the two standard seats	1	11.60e)	11-216
Standard Sleeper Cabin Headboard	Standard Sleeper Cabin includes a firmly cushioned panel behind the seat that serves as a headboard in the berth configuration.	1	11.60f)	11-217
Cup Holder	Cupholders built into side wall and center armrest	2	11.60l)	11-218
Bottle Holder	Small storage location in carshell side wall	2	11.60m)	11-218
Single Leaf Fold Out Table	Table built into side wall	2	11.60n)	11-219
Upper Sleeping Berth				
Upper Berth	Includes retaining straps,	1	11.61a)	11-220
Upper Berth Grab Bar	49 CFR 38.115 compliant handrails	As needed	11.61b)	11-221
Upper Berth Ladder	Rigid ladder structure for accessing upper berth in accessible sleeper room	1	11.61d)	11-222
Personal Care				
Solid Surface Sink	Solid surface sink counter and basin	1	11.62c)	11-224
Accessible Sink Vanity Cabinet	Storage cabinet in sink area	1	11.62e)	11-226
Sink Vanity Mirror	Mirror with boarder LED light or backlight	1	11.62f)	11-226
Handsoap Dispenser	Base for handsoap installed adjacent to the over-sink mirror.	1	11.62j)	11-228
Lotion Bottle	Lotion bottle next to sink	1	11.62k)	11-228
Towel Ring	Install near sink.	1	11.62l)	11-228
Hand Dryer	Automatic hand dryer	1	11.62m)	11-228
Restroom Wall Mirror	Mirror with border LED light or backlight	1	11.62n)	11-228
Shower Curtain	Opaque shower curtain that is adjustable in Accessible sleeper restroom	1	11.62p)	11-229
Shower Seat	Seating platform in shower	1	11.62q)	11-229

CONFIDENTIAL — DO NOT DISTRIBUTE

Figure 11-25: Key Features - Accessible Twin (continued)

Feature	Short Description	Qty	Reference	Page
Rain Shower	Shower head mounted on the ceiling	1	11.62r)	11-229
Shower Control	Adjustment for water pressure and temperature in the shower	1	11.62t)	11-230
Shower Drainage	Drain location for shower	1	11.62u)	11-230
Shower Exhaust	Adjustable exhaust grille	1	11.62v)	11-230
Soap Dish	Storage location for personal soap items in shower	1	11.62w)	11-231
Soap Dispensing Bottles	Refillable soap, conditioner, and lotion bottles mounted on wall	3	11.62x)	11-231
Towel Hook	Installed on partition wall	2	11.62y)	11-231
Towel Rail	Rail for folded towel hanging	1	11.62z)	11-231
Standard Towel Storage	Elevated towel rack	1	11.62aa)	11-231
Toilet	Assembly including toilet bowl, accessible shroud, and overflow pan	1	11.62hh)	11-233
Toilet Seat	Assembly including lid and seat for toilet	1	11.62ii)	11-234
Toilet Flush	Push button flush and automatic flush mechanisms	1	11.62jj)	11-234
Toilet Paper Dispenser	Protective location for dispensing toilet paper	1	11.62kk)	11-234
Toilet Seat Cover Dispenser	Protective location for dispensing seat covers	1	11.62ll)	11-235
Baby Changing Table	Fold out table for infant diaper care	1	11.62nn)	11-235
Full Length Mirror	Long mirror mounted on sidewall of restroom or cabinet	1	11.62qq)	11-236
Trash				
Seating Area Trash Bin	Tip out small storage for sleeper room trash	1	11.63a)	11-237
Restroom Trash	Storage for restroom related trash	1	11.63c)	11-237
Sanitary Waste	Storage location for used feminine hygiene products	1	11.63e)	11-238
Sharps Bin	Storage location for used needles and other medical waste	1	11.63f)	11-238
Storage				
Upper Cabinet	Storage location with a door	1	11.64c)	11-239
Lower Cabinet	Storage location with a door	1	11.64d)	11-239
Open Wardrobe	Open storage location with coat rod	1	11.64f)	11-240
Coat Hooks	Installed on the partition wall adjacent to the door	2	11.64h)	11-241
Carryon Luggage Storage	Storage cubby for carryon sized luggage	1	11.64i)	11-241
Under Seat Storage	Open space for carryon sized luggage	1	11.64j)	11-242
Seat Shelf	Additional storage shelf adjacent to seats in accessible room	1	11.64k)	11-243

CONFIDENTIAL — DO NOT DISTRIBUTE

Figure 11-25: Key Features - Accessible Twin (continued)

Upper Cubby	Cubby adjacent to upper berth with outlet and ambiance lighting	1	11.64l)	11-243
Sidewall Cubby	Storage location in carshell side wall	1	11.64n)	11-243
High Storage Shelf	Storage shelf above 48" ADA reach	1	11.64p)	11-244
Restroom Crew Storage	Locker with square key for dedicated crew storage	1	11.64r)	11-244

c). Functional Elements

i). Seat to Lower Berth Conversion

- (1) A simple unlatch mechanism is required to convert the seats into a lower bed/berth.
- (2) This should be positioned in a place that is easy for people to use and designed in a way so that people can understand its purpose.
- (3) The latch should be free for jamming and free from any finger trap hazards.
- (4) The position of the latch shall be ADA reach compliant.
- (5) Controls and operating mechanisms shall be operable with one hand and shall not require tight grasping, pinching, or twisting of the wrist.
- (6) There should be an assisted mechanism making it easy for passengers of any ability to self-sufficiently and safely deploy and store the bed.
- (7) Conversion of seats to lower berth shall result in an entirely flat sleeping surface.
- (8) The mattress surface should be integral to the back of the seat. A single seam between the bed surface is acceptable with a single thin topper will finish the bed surface.
- (9) There shall be no movement in the lower berth structure under full loading conditions when the lower berth is deployed.
- (10) A supplemental cushion shall be permanently mounted at seat level on the partition wall side of the seat below the seat shelf and shall function to expand the length of the bed.
- (11) Design of the bed should allow people to sleep in both directions.
- (12) Any furnishings set above the bed surface must not present a hazard or head strike when using the bed.
- (13) Lower Berth Dimensions: Minimum width 34" x Minimum length 75"

ii). Deploying Upper Berth

- (1) The upper berth should be stored horizontally at the maximum height in the room.
- (2) When stowed, the upper berth should not block any part of the window or window removal in the event of an emergency.
- (3) Leading edges should be soft in form to minimize impact to any potential head strike.

- (4) The berth's stored height should be maximized so head clearance is at a maximum in both seated and standing positions.
 - (5) A simple and easy to use handle, latch, and lock mechanism should be within easy reach from a standing position.
 - (6) Successful locking should be visually indicated, and safety measures should be put in place to prevent accidental deployment and prevent misuse.
 - (7) The upper berth deployment should be free from jamming and racking and should lower slowly and in a controlled manner.
 - (8) Considerations should be made for assisted movement or counterbalances to assist people moving the upper berth down and back up into the stowed position.
 - (9) Mitigation should be made to avoid finger traps across any mechanism, rails, or support structures.
 - (10) Upper Berth Dimensions: Minimum width 28" x Minimum length 78"
- d). Accessibility Features
- i). 39" Room Door
 - (1) Access to the room will be subject to review and mockup user testing. Room doors should be automatic sliding doors.
 - (2) The door shall also be able to operate in a manual mode in the event of power loss or malfunction so that the room is not put out of service due to door operation failure.
 - ii). Handrail Locations
 - (1) Horizontal Handrails
 - (a) ADA compliant horizontal handrails positioned to assist transfer through the sleeper room shall be provided.
 - (b) The handrail should be positioned to maximize the space between the room features while providing maximum access and support for passengers.
 - (i) Adjacent to aisle side seat
 - (ii) Adjacent to window side seat
 - (iii) On the cabinet near the door threshold
 - (iv) Adjacent to bed along partition wall and above mattress
 - (v) Along the underside of the window

- (vi) Shower handrail along 3 walls of restroom
- (2) Vertical Handrails
 - (a) ADA compliant vertical handrails positioned to assist transfer through the sleeper room shall be provided.
 - (b) The handrail should be positioned to maximize the space between the room features while providing maximum access and support for passengers.
 - (i) Either side of restroom door
 - (ii) On the cabinet near the door and upper berth
 - (iii) Inside restroom adjacent to door
 - (iv) Adjacent to toilet
 - (v) Fold down handrail between toilet and shower
- iii). Control Buttons
 - (1) Room door
 - (a) The controls for the room door must be ADA compliant in position, size, and configuration.
 - (i) Door Open/Close
 - (ii) Door Lock
 - (b) The buttons should be easy and intuitive to use.
 - (c) An accessible manual lock should be included with an indicator to show lock condition.
 - (d) The buttons should have visual and haptic feedback.
 - (e) Dimensions, position, and usability will be subject to Amtrak approval during mockup review.
 - (i) Note this review will include the disability community input.
 - (2) Restroom door
 - (a) The controls for the restroom door shall have the same features as the room door.
 - (i) Door Open/Close
 - (ii) Door Lock

- iv). 36" Restroom Door
 - (1) The Restroom door should be an automatic sliding door.
 - (2) The door should be positioned to create space for a T-maneuver when the door is open and the bed is deployed.
- v). 60" Turning Circle
 - (1) Center of room
 - (a) A clear 60" turning circle should be provided inside the room when the seats are in an upright position.
 - (b) Turning circle shall be clear when fold out table, bed, ladder, and tip up seats are deployed.
 - (2) Restroom Interior
 - (a) A clear 60" turning circle shall be provided inside the restroom when shower curtain is stored and shower seat is in the upright position.
- vi). Adjustable Features with Clearances
 - (1) Tip up seat
 - (2) Fold out table
 - (a) Two separate fold out tables should be positioned so when deployed should be clear of an RVAAC accessible space and an ADA accessible space.
- vii). Accessible Space for wheeled mobility devices
 - (1) A clear accessible space of 59" x 32"
 - (a) This shall be provided inside the room when the seats are in an upright position.
 - (2) An RVACC accessible space of 59" x 32" shall be provided in each of the following locations:
 - (a) Beside the bed for storing a wheeled mobility device.
 - (b) In front of the restroom sink.
 - (c) Between the shower seat and toilet seat for storing a wheeled mobility device.
 - (d) Between the shower seat and the restroom entrance door for storing a wheeled mobility device.

viii). Lighting

ix). General

- (1) Lighting general information is shared in the points below.
- (2) Approximate lighting locations and types are shown in the following Figures:
 - (a) Figure 11-101: Accessible Twin Wash Light Locations
 - (b) Figure 11-102: Accessible Twin Spot Light Locations
 - (c) Figure 11-103: Accessible Twin Compartment Light Locations
 - (d) Figure 11-104: Accessible Twin Reading Light Locations
 - (e) Figure 11-105: Accessible Twin Ceiling Pool Light Locations
 - (f) Figure 11-106: Accessible Twin Ladder Light Locations
 - (g) Figure 11-107: Accessible Sleeper Cabin Restroom Lighting
- (3) General
 - (a) Lighting general information is shared in the points below.
 - (b) The points below are accompanied with diagram to show approximate lighting locations and types.
- (4) Wash Lights (RGB Lights)
 - (a) Wall Wash Lights
 - (i) Wall wash lights for the aisle partition wall and the back walls behind the seats shall be provided along the length of each wall. (see Figure 11-101 on page 11-360)
 - (b) Ceiling Wash Lights
 - (i) Ceiling wash lights shall run the length of the room along the window line.
 - (ii) This light shall function to illuminate the underside of the upper berth when stored and to illuminate the ceiling when the upper berth is deployed.
 - (c) Back Wall Wash Uplight
 - (i) Back wall wash uplight shall light from the back of the seat toward the upper berth.
 - (d) Back Wall Wash Downlights

- (i) Back wall wash upper downlight shall light from the upper berth toward the seat.
 - (ii) Back wall wash lower downlight shall light from the ceiling onto the upper berth when it is deployed.
- (5) LED Panel Spot Lights (White Lights)
 - (a) Two small circular LED light panels shall act as spot lights near the entrance door. (see Figure 11-102 on page 11-361)
 - (b) The frame for the spot lights shall be color matched to the ceiling.
- (6) Compartment Lights (RGB Lights)
 - (a) See Figure 11-103 on page 11-362.
 - (b) Lower Cubby shall have a strip of indirect lighting to illuminate this cubby under the ottoman and the inside of the luggage storage area.
 - (c) Side wall cubbies shall have a strip of indirect lighting to illuminate each cubby. This includes the sidewall and bottle holding cubbies.
 - (d) Upper Cubby shall be lit with indirect lighting and shall allow the entire cubby to act as indirect lighting for the room as well.
 - (e) Under Seat lights shall be provided as indirect lighting that spills out across the floor under the seat.
- (7) Shelf Strip Light
 - (a) Each shelf shall have an indirect strip light that washes from the underside of each shelf above.
 - (b) This includes all storage cubby shelves, the seat shelf, and the high storage shelf.
- (8) Reading Lights (White Lights)
 - (a) Upper Reading Lights
 - (i) Upper reading lights shall be embedded into the ceiling panel above the upper berth.
 - (ii) These should be two mini panel lights with one light at each end of the bed.
 - (iii) Reading light switches should be located next to the reading light.
 - (b) Lower Reading Lights
 - (i) Lower reading lights shall be provided at each seated position.

- (ii) The light itself shall be adjustable so that the passenger can adjust the direction to position the light over their reading material.
 - (iii) Reading light switches should be located next to the reading light.
- (9) Corner Lamp
 - (a) A corner lamp shall wash indirect light both up and down. The switch for this light shall be located next to the lamp.
 - (b) See Figure 11-104 on page 11-363.
- (10) Ceiling Lighting (White Light)
 - (a) A feature pool light shall be central to the ceiling (see Figure 11-105 on page 11-364).
 - (b) This shall provide indirect wall washing across the ceiling at the center of the room.
- (11) Ladder Lighting (White Light)
 - (a) Battery powered step light should be integrated into the ladder and wash light over each of the steps (see Figure 11-106 on page 11-365).
- (12) Restroom Lighting (RGB Lights)
 - (a) See Figure 11-107 on page 11-366.
 - (b) Back Wall Wash Light
 - (i) A back wall wash light shall be mounted to the towel shelf and provide both up and down wall washing lighting.
 - (ii) This shall only activate when the door to the restroom is locked.
 - (c) Spot Light
 - (i) A LED spot light shall be located on the ceiling above the toilet and adjacent to the rain shower.
 - (ii) This shall only activate when the door to the restroom is locked.
 - (iii) This shall be a white light.
 - (d) Floor Lights
 - (i) Lights shall be provided as indirect lighting that spills out across the floor under the sink counter.

- (e) Sink Light
 - (i) A wash light should be used to light the sink area indirectly.
 - (ii) This light shall only be activated when the door to the restroom is locked.
- (f) Crew Storage
 - (i) Cabinet shall include an internal light source that activates when the door is opened.
- (g) Mirror
 - (i) A rounded LED light shall illuminate the mirror around the boarder.
 - (ii) This light shall only be activated when the door to the restroom is locked.
- (h) Baby Changing Table
 - (i) Indirect lighting shall wash down the baby changing wall when the changing table is deployed.
 - (ii) Angle and brightness of light shall be approved by Amtrak during mockup review.
 - (iii) The design shall make efforts to avoid accidental direct light to the eyes of a baby on the changing table.

11.53 Accessible Double

a). General

- i). The Accessible Double is a fully accessible room for two.
- ii). The room has a double bed.
- iii). The accessible space is based on the RVACC recommendations to accommodate larger mobility devices.
- iv). The ability to turn around in the room is facilitated by a clear 60" turning circle in day and nighttime conditions.
- v). The room has an ensuite restroom that is also fully accessible with a lockable door separating it from the living space.
- vi). The Accessible Double should be a maximum of 162" long and designed for a 32" side aisle.
- vii). The restroom module should be the same across both the Accessible Double and the Accessible Twin.
- viii). All features shall be reached by a person sitting in a wheeled mobility device unless otherwise listed in this section.
- ix). Dimensions and anthropomorphic data shall be taken from the Americans with Disabilities Act.
- x). Please refer to Chapter 1 for information regarding quantity of this accommodation type desired across the trainset and suggested layouts.
- xi). To the extent possible, the Contractor shall adhere to the general arrangement images for the bedroom cabin as shown in Figure 11-108 on page 11-367.

b). Key Features

- i). A comprehensive list of expected features in this type of sleeper cabin is provided in Figure 11-26 and described in detail in the subsequent sections referenced in the table.
- ii). Detailed functional requirements for each feature is listed below.

Figure 11-26: Key Features - Accessible Double

Feature	Short Description	Qty	Reference	Page
General Items				
Accessible Sleeper Cabin Door	39" sliding door that includes window, blind and door lock mechanism. Automatic Operation.	1	11.58b)	11-202
Accessible Sleeper Cabin Door Controls	ADA accessible controls for operating doors	2	11.58c)	11-202
Accessible Sleeper Cabin Restroom Door	Sliding two panel automatic door for accessible sleeper restroom	1	11.58e)	11-204
Accessible Sleeper Cabin Restroom Door Controls	ADA accessible controls for operating doors	2	11.58f)	11-205
Side Window	Includes emergency egress features	1	11.58i)	11-206
Side Window Blinds	Light filtering and black out blind	2	11.58j)	11-206
Outlets	Duplex outlet with USB. See Figure 11-110 on page 11-369 for outlet locations.	Figure 11-29	11.58o)	11-208
Master Light Switch	Light switch that can turn on or off all lights in a sleeper room	1	11.58p)	11-209
Master Control Screen	Touchscreen tablet for controlling room environment and opting into train experience features	1	11.58q)	11-209
Master Thermostat Control	Mechanical Interface control of temperature settings	1	11.58r)	11-209
Floor Heat	Heating mechanism for room	1	11.58s)	11-209
Standard Grab Bars	49 CFR 38.115 compliant handrails	As needed	11.58t)	11-210
Restroom Grab Bars	49 CFR 38.123 compliant handrails	As needed	11.58u)	11-210
Communications				
Digital Displays	Digital display monitors	Figure 11-4	11.25	11-26
Passenger Information Screen	Space should be provided for an additional passenger information screen in all accessible rooms (PIS/OTIS)	1	11.59a)	11-210
Attendant Call Button	LED Button to page Crew	1	11.59b)	11-210
Emergency Call Button	Buttons in accessible locations that activate PEI	2	11.59b)	11-210

CONFIDENTIAL — DO NOT DISTRIBUTE

Figure 11-26: Key Features - Accessible Double (continued)

Feature	Short Description	Qty	Reference	Page
PEI - Intercom only	Speaker for emergency conversations	1	11.59d)	11-211
Seating Area / Lower Sleeping Berth				
Standard Sleeper Cabin Seats	Includes fold down features to convert into bed.	2	11.60a)	11-211
Tip Up Seat	Wall mounted seat that can fold away when not in use	1	11.60c)	11-216
Standard Sleeper Cabin Arm Rests	Standard Sleeper Cabin Armrest built into sidewall.	2	11.60d)	11-216
Center Armrest	Center armrest between the two standard seats	1	11.60e)	11-216
Standard Sleeper Cabin Headboards	Includes a firmly cushioned panel behind the seat that serves as a headboard in the berth configuration.	1	11.60f)	11-217
Cup Holder	Cupholders built into side wall and center arm rest	2	11.60l)	11-218
Bottle Holder	Small storage location in carshell side wall	2	11.60m)	11-218
Single Leaf Fold Out Table	Table built into side wall. Note that there are two of these fold out tables mounted adjacent to each other on the side wall below the window.	2	11.60n)	11-219
Personal Care				
Solid Surface Sink	Solid surface sink counter and basin	1	11.62c)	11-224
Accessible Vanity Cabinet	Storage cabinet in sink area	1	11.62e)	11-226
Sink Vanity Mirror	Mirror with boarder LED light or backlight	1	11.62f)	11-226
Hand Soap Dispenser	Base for hand soap installed adjacent to the over-sink mirror.	1	11.62j)	11-228
Lotion Bottle	Lotion bottle next to sink	1	11.62k)	11-228
Towel Ring	Install near sink.	1	11.62l)	11-228
Hand Dryer	Automatic hand dryer	1	11.62m)	11-228
Restroom Wall Mirror	Mirror with border LED light or backlight	1	11.62n)	11-228
Shower Curtain	Opaque shower curtain that is adjustable in Accessible sleeper restroom	1	11.62p)	11-229
Shower Seat	Seating platform in shower	1	11.62q)	11-229
Rain Shower	Shower head mounted on the ceiling	1	11.62r)	11-229
Adjustable Shower Head	Handheld shower head	1	11.62s)	11-230

CONFIDENTIAL — DO NOT DISTRIBUTE

Figure 11-26: Key Features - Accessible Double (continued)

Feature	Short Description	Qty	Reference	Page
Shower Control	Adjustment for water pressure and temperature in the shower	1	11.62t)	11-230
Shower Drainage	Drain location for shower	1	11.62u)	11-230
Shower Exhaust	Coat hooks that hold up to 25lbs	1	11.62v)	11-230
Soap Dish	Storage location for personal soap items in shower	1	11.62w)	11-231
Soap Dispensing Bottles	Refillable soap, conditioner, and lotion bottles mounted on wall	3	11.62x)	11-231
Towel Hook	Install on the partition wall.	2	11.62y)	11-231
Towel Hook	Installed near the entrance to the shower door.	1	11.62y)	11-231
Towel Rail	Rail for hanging folded hand towel	1	11.62z)	11-231
Standard Towel Storage	Elevated towel rack	1	11.62aa)	11-231
Toilet	Assembly including toilet bowl, shroud, and overflow pan	1	11.62hh)	11-233
Toilet Seat	Assembly including lid and seat for toilet	1	11.62ii)	11-234
Toilet Flush Mechanism	Push button flush and automatic flush mechanisms	1	11.62jj)	11-234
Toilet Paper Dispenser	Protective location for dispensing toilet paper	1	11.62kk)	11-234
Toilet Seat Cover Dispenser	Protective location for dispensing seat covers	1	11.62ll)	11-235
Baby Changing Table	Fold out table for infant diaper care	1	11.62nn)	11-235
Full Length Mirror	Long mirror mounted on sidewall of restroom or cabinet	1	11.62qq)	11-236
Trash				
Seating Area Trash Bin	Flip out storage for sleeper room trash	1	11.63a)	11-237
Restroom Trash	Storage for restroom related trash	1	11.63c)	11-237
Sanitary Waste	Storage location for used feminine hygiene products	1	11.63e)	11-238
Sharps Bin	Storage location for used needles and other medical waste	1	11.63f)	11-238
Storage				
Cabinet	Storage location with a door	1	11.64a)	11-238
Open Wardrobe	Open storage location with coat rod	1	11.64f)	11-240
Coat Hooks	Installed on partition wall, a maximum of 48" from the floor.	2	11.64h)	11-241
Carryon Luggage Storage	Storage cubby for carryon sized luggage	1	11.64i)	11-241

CONFIDENTIAL — DO NOT DISTRIBUTE

Figure 11-26: Key Features - Accessible Double (continued)

Feature	Short Description	Qty	Reference	Page
Under Seat Storage	Open space for carryon sized luggage	1	11.64j)	11-242
Seat Shelf	Additional storage shelf adjacent to seats in accessible room	1	11.64k)	11-243
Seat Cubby	Three shelves near the berth for personal storage	1	11.64m)	11-243
Sidewall Cubby	Storage location in carshell side wall	1	11.64n)	11-243
High Storage Shelf	Storage shelf above 48" ADA reach	1	11.64p)	11-244
Seating Area Crew Storage	Locker with square key for dedicated crew storage	1	11.64q)	11-244

c). Functional Elements

i). Seat to Lower Berth Conversion

- (1) A simple unlatch mechanism is required to convert the seats into a bed/berth.
- (2) This should be positioned in a place that is easy for people to use and designed in a way so that people can understand its purpose.
- (3) The latch should be free for jamming and free from any finger trap hazards.
- (4) The position of the latch shall be ADA reach compliant.
- (5) Controls and operating mechanisms shall be operable with one hand and shall not require tight grasping, pinching, or twisting of the wrist.
- (6) There should be an assisted mechanism making it easy for passengers of any ability to self-sufficiently and safely deploy and store the bed.
- (7) Conversion of seats to berth shall result in an entirely flat sleeping surface.
- (8) The mattress surface should be integral to the back of the seat.
- (9) A single seam between the bed surface is acceptable with a single thin topper will finish the bed surface.
- (10) There shall be no movement in the lower berth structure under full loading conditions when the lower berth is deployed.
- (11) A supplemental cushion shall be permanently mounted at seat level on the partition wall side of the seat below the seat shelf and shall function to expand the length of the bed.
- (12) Design of the bed should allow people to sleep in both directions.
- (13) Any furnishings set above the bed surface must not present a hazard or head strike when using the bed.
- (14) Lower Berth Dimensions: Minimum width 48" x Minimum length 75"

d). Accessibility Features

i). 39" Room Door

- (1) Access to the room will be subject to review and mockup user testing. Room doors should be and automatic sliding door.

- (2) The door shall also be able to operate in a manual mode in the event of power loss or malfunction so that the room is not put out of service due to door operation failure.
- ii). Handrail Locations
 - (1) Horizontal Handrails
 - (a) ADA compliant horizontal handrails positioned to assist transfer through the sleeper room shall be provided.
 - (b) The handrail should be positioned to maximize the space between the room features while providing maximum access and support for passengers.
 - (i) Adjacent to aisle side seat
 - (ii) Adjacent to window side seat
 - (iii) On the cabinet near the door threshold
 - (iv) Adjacent to bed along partition wall and above mattress
 - (v) Along the underside of the window
 - (vi) Shower handrail along 3 walls of restroom
 - (2) Vertical Handrails
 - (a) ADA compliant vertical handrails positioned to assist transfer through the sleeper room shall be provided.
 - (b) The handrail should be positioned to maximize the space between the room features while providing maximum access and support for passengers.
 - (i) Either side of restroom door
 - (ii) Adjacent to toilet
 - (iii) Fold down handrail between toilet and shower
 - (iv) Control Buttons
 - iii). Room Door Controls
 - (1) The controls for the room door must be ADA compliant in position, size, and configuration.
 - (2) The buttons should be easy and intuitive to use.
 - (3) An accessible manual lock should be included with an indicator to show lock condition.

- (4) The buttons should have visual and haptic feedback.
 - (5) Dimensions, position, and usability will be subject to Amtrak approval during mockup review.
 - (6) Note this review will include the disability community input.
 - (a) Door Open/Close
 - (b) Door Lock
- iv). Restroom Door Controls
- (1) The controls for the restroom door shall have the same features as the room door.
 - (2) Door Open/Close
 - (3) Door Lock
- v). 36" Restroom Door
- (1) The Restroom door should be an automatic sliding door.
 - (2) The door should be positioned to create space for a T-maneuver when the door is open and the bed is deployed.
- vi). 60" Turning Circle
- (1) Center of room- A clear 60" turning circle should be provided inside the room when the seats are in an upright position.
 - (2) Turning circle shall be clear when fold out table and tip up seats are deployed.
 - (3) Alternatively, an ADA T maneuver space shall be available when the bed is deployed.
 - (4) Restroom Interior- a clear 60" turning circle shall be provided inside the restroom when shower curtain is stored and shower seat is in the upright position.
- vii). Adjustable Features with Clearances
- (1) Tip up seat
 - (2) Fold out table
 - (a) Two separate fold out tables should be positioned so when deployed should be clear of an RVAAC accessible space and an ADA accessible space.

viii). Accessible Space for wheeled mobility devices

- (1) A clear accessible space of 59" x 32"
 - (a) This shall be provided inside the room when the seats are in an upright position.
- (2) An RVACC accessible space of 59" x 32" shall be provided in each of the following locations:
 - (a) Beside the bed for storing a wheeled mobility device.
 - (b) In front of the restroom sink.
 - (c) Between the shower seat and toilet seat for storing a wheeled mobility device.
 - (d) Between the shower seat and the restroom entrance door for storing a wheeled mobility device .

e). Lighting

i). General

- (1) Lighting general information is shared in the points below.
- (2) Approximate lighting locations and types are shown in the following Figures:
 - (a) Figure 11-111: Accessible Double Wash Light Locations
 - (b) Figure 11-112: Accessible Double Spot Light Locations
 - (c) Figure 11-113: Accessible Double Compartment Light Locations
 - (d) Figure 11-114: Accessible Double Reading Light Locations
 - (e) Figure 11-115: Accessible Double Ceiling Pool Light Locations
 - (f) Figure 11-116: Accessible Sleeper Cabin Restroom Lighting

ii). Wash Lights (RGB Lights)

- (1) Wall wash lights for the aisle partition wall and the back walls behind the seats shall be provided along the length of each wall. (see Figure 11-111 on page 11-370)
- (2) Ceiling wash lights shall run the length of the room along the window line.
- (3) This light shall function to illuminate the underside of the upper berth when stored and to illuminate the ceiling when the upper berth is deployed.

- iii). LED Panel Spot Lights (White Lights)
 - (1) Two small circular LED light panels shall act as spot lights near the entrance door. (see Figure 11-44 on page 11-294)
 - (2) The frame for the spot lights shall be color matched to the ceiling.
- iv). Compartment Light (RGB Lights)
 - (1) Lower Cubby shall have a strip of indirect lighting to illuminate this cubby under the ottoman and the inside of the luggage storage area. (see Figure 11-113 on page 11-372)
 - (2) Side wall cubbies shall have a strip of indirect lighting to illuminate each cubby. This includes the sidewall and bottle holding cubbies.
 - (3) Under Seat lights shall be provided as indirect lighting that spills out across the floor under the seat.
- v). Shelf Lights
 - (1) Each shelf shall have an indirect strip light that washes from the underside of each shelf above.
 - (2) This includes all storage cubby shelves, the seat shelf, and the high storage shelf.
- vi). Reading Light (White Lights)
 - (1) Lower reading lights shall be provided at each seated position. (see Figure 11-114 on page 11-373)
 - (2) The light itself shall be adjustable so that the passenger can adjust the direction to position the light over their reading material.
 - (3) Reading light switches should be located next to the reading light.
 - (4) A corner lamp shall wash indirect light both up and down.
 - (5) The switch for this light shall be located next to the lamp.
 - (6) Three of these lamps shall be provided in the Accessible Double.
- vii). Ceiling Lighting in the Accessible Double Room (White Lights)
 - (1) A feature pool light shall be central to the ceiling. (see Figure 11-115 on page 11-374)
 - (2) This shall provide indirect wall washing across the ceiling at the center of the room.
- viii). Restroom Lighting in the Accessible Double Room (RGB Lights)

- (1) See Figure 11-116 on page 11-375.
- (2) Back Wall Wash Light
 - (a) A back wall wash light shall be mounted to the towel shelf and provide both up and down wall washing lighting.
 - (b) This shall only activate when the door to the restroom is locked.
- (3) Ceiling Spotlight
 - (a) A LED spotlight shall be located on the ceiling above the toilet and adjacent to the rain shower.
 - (b) This shall only activate when the door to the restroom is locked.
 - (c) This light shall be a white light only.
- (4) Floor
 - (a) Lights shall be provided as indirect lighting that spills out across the floor under the sink counter.
- (5) Sink
 - (a) A wash light should be used to light the sink area indirectly.
 - (b) This light shall only be activated when the door to the restroom is locked.
- (6) Crew Storage
 - (a) Cabinet shall include an internal light source that activates when the door is opened.
- (7) Mirror
 - (a) A rounded LED light shall illuminate the mirror around the boarder.
 - (b) This light shall only be activated when the door to the restroom is locked.
- (8) Baby Changing Table
 - (a) Indirect lighting shall wash down the baby changing wall when the changing table is deployed.
 - (b) Angle and brightness of light shall be approved by Amtrak during mockup review.
 - (c) The design shall make efforts to avoid accidental direct light to the eyes of a baby on the changing table.

11.54 Accessible Premium Bedroom

a). General

- i). The Accessible Premium Bedroom is a fully accessible room for two passengers who use wheeled mobility devices and two additional passengers.
- ii). The room has four separate sleeping spaces divided into two lower berths and two upper berths.
- iii). The accessible space is based on the RVACC recommendations to accommodate larger mobility devices.
- iv). The ability to turn around in the room is facilitated by a clear 60" turning circle in day and nighttime conditions.
- v). The room has an ensuite restroom that is also fully accessible with a lockable door separating it from the living space.
- vi). Access shall be provided in and out of the room and to the bathroom and shower when the beds are full deployed.
- vii). The Accessible Premium Bedroom should occupy the entire width of the lower level of the car and shall be as short as possible while still including all necessary features listed in this section.
- viii). All features shall be reached by a person sitting in a wheeled mobility device unless otherwise listed in this section.
- ix). Wheeled mobility devices shall be able to pass each other and maneuver without one device being removed from the space or trapping a wheeled mobility device user to one part of the room.
- x). Dimensions and anthropomorphic data shall be taken from the Americans with Disabilities Act.
- xi). Please refer to Chapter 1 for information regarding quantity of this accommodation type desired across the trainset and suggested layouts.
- xii). No renderings have been provided for this sleeper cabin.
- xiii). The Contractor shall propose a layout that accommodates the listed items below and captures the same level of luxury as the Premium Bedroom.
- xiv). The Contractor shall share conceptual drawings prior to PDR and a detailed layout at the PDR stage for Amtrak approval.

b). Key Features

- i). A comprehensive list of expected features in this the Accessible Premium Bedroom is provided in Figure 11-27 and described in detail in the subsequent sections referenced in the table.

- ii). Detailed functional requirements for each feature is listed below.

Figure 11-27: Key Features - Accessible Premium Bedroom

Feature	Short Description	Qty	Reference	Page
General Items				
Accessible Sleeper Cabin Door	39" sliding door that includes window, blind and door lock mechanism. Automatically operated.	1	11.58b)	11-202
Accessible Sleeper Cabin Door Controls	ADA accessible controls for operating sleeper cabin door	1	11.58c)	11-202
Accessible Sleeper Cabin Restroom Door	36" Sliding two panel automatic door for accessible sleeper restroom	1	11.58e)	11-204
Accessible Sleeper Cabin Restroom Door Controls	ADA accessible controls for operating sleeper cabin restroom door	1	11.58f)	11-205
Accessible Sleeper Cabin Shower Room Door	Sliding two panel automatic door for accessible sleeper shower	1	11.58e)	11-204
Accessible Sleeper Cabin Shower Door Controls	ADA accessible controls for operating sleeper cabin shower room door	1	11.58f)	11-205
Side Windows	Includes emergency egress features	2	11.58i)	11-206
Side Window Blinds	Light filtering and black out blind	4	11.58j)	11-206
Outlets	Duplex outlets with USB. GFCI in restroom.	Figure 11-29	11.58o)	11-208
Master Light Switch	Light switch that can turn on or off all lights in a sleeper room	2	11.58p)	11-209
Master Control Screen	Touchscreen tablet to control room environment and opt into train experience features	1	11.58q)	11-209
Master Thermostat Control	Mechanical Interface control of temperature settings	1	11.58r)	11-209
Floor Heat	Heating mechanism for room	1	11.58s)	11-209
Standard Grab Bars	49 CFR 38.115 compliant handrails	As needed	11.58t)	11-210
Restroom Grab Bars	49 CFR 38.123 compliant handrails	As needed	11.58u)	11-210
Communications				
Digital Displays	Digital display monitor	Figure 11-4	11.25	11-26

CONFIDENTIAL — DO NOT DISTRIBUTE

Figure 11-27: Key Features - Accessible Premium Bedroom (continued)

Feature	Short Description	Qty	Reference	Page
Passenger Information Screen	Space should be provided for an additional passenger information screen in all accessible rooms (PIS/OTIS)	1	11.59a)	11-210
Emergency Call Button	Buttons in accessible locations that activate PEI	2	11.59b)	11-210
PEI - Intercom only	Speaker for emergency conversations	1	11.59d)	11-211
Seating Area / Lower Sleeping Berth				
Standard Sleeper Cabin Seat	Includes fold down features to convert into bed	2	11.60a)	11-211
Tip Up Seat	Wall mounted seat that can fold away when not in use	2	11.60c)	11-216
Standard Sleeper Cabin Arm Rest	Built into sidewall and center armrest	2	11.60d)	11-216
Center Armrest	Center armrest between the two standard seats	1	11.60e)	11-216
Standard Sleeper Cabin Headboard	A firmly cushioned panel behind seat that serves as headboard in berth configuration.	2	11.60f)	11-217
Cup Holder	Cupholders built into side wall and center armrest	6	11.60l)	11-218
Bottle Holder	Small storage location in carshell side wall	4	11.60m)	11-218
Single Leaf Fold Out Table	Table built into side wall. Note that there are four of these fold out tables mounted adjacent to each other on the side wall below each window.	4	11.60n)	11-219
Upper Sleeping Berth				
Upper Berth	Includes retaining straps,	1	11.61a)	11-220
Upper Berth Grab Bar	49 CFR 38.115 compliant handrails	As needed	11.61b)	11-221
Upper Berth Ladder	Rigid ladder structure for accessing upper berth in accessible sleeper room	1	11.61d)	11-222
Drink Station	Location with provisions for coffee maker and associated condiments	1	11.62a)	11-223
Solid Surface Sink	Solid surface sink counter and basin	1	11.62c)	11-224
Accessible Sink Vanity Cabinet	Storage cabinet in sink area	1	11.62e)	11-226

CONFIDENTIAL — DO NOT DISTRIBUTE

Figure 11-27: Key Features - Accessible Premium Bedroom (continued)

Feature	Short Description	Qty	Reference	Page
Sink Vanity Mirror	Mirror with boarder LED light or backlight	1	11.62f)	11-226
Accessible Sink Vanity Shelves	Shelves adjacent to sink area	1	11.62h)	11-227
Handsoap Dispenser	Base for handsoap installed adjacent to the over-sink mirror.	1	11.62j)	11-228
Lotion Bottle	Lotion bottle next to sink	1	11.62k)	11-228
Towel Ring	Install near sink.	1	11.62l)	11-228
Hand Dryer	Automatic hand dryer and paper towel dispenser	1	11.62m)	11-228
Shower Curtain	Opaque shower curtain that is adjustable in Accessible sleeper restroom	1	11.62p)	11-229
Shower Seat	Seating platform in shower	1	11.62q)	11-229
Rain Shower	Shower head mounted on the ceiling	1	11.62r)	11-229
Adjustable Shower Head	Handheld shower head	1	11.62s)	11-230
Shower Control	Adjustment for water pressure and temperature in the shower	1	11.62t)	11-230
Shower Drainage	Drain location for shower	1	11.62u)	11-230
Shower Exhaust	Adjustable exhaust grille	1	11.62v)	11-230
Soap Dish	Storage location for personal soap items in shower	1	11.62w)	11-231
Soap Dispensing Bottles	Refillable soap, conditioner, and lotion bottles mounted on wall	3	11.62x)	11-231
Towel Hook	Install on the partition wall.	2	11.62y)	11-231
Towel Hook	Installed near the entrance to the shower door.	2	11.62y)	11-231
Towel Rail	Rail for folded towel hanging	1	11.62z)	11-231
Standard Towel Storage	Elevated towel rack	1	11.62aa)	11-231
Toilet	Assembly including toilet bowl, shroud, and overflow pan	1	11.62hh)	11-233
Toilet Seat	Assembly including lid and seat for toilet	1	11.62ii)	11-234
Toilet Flush Mechanism	Push button flush and automatic flush mechanisms	1	11.62jj)	11-234
Toilet Paper Dispenser	Protective location for dispensing toilet paper	1	11.62kk)	11-234
Toilet Seat Cover Dispenser	Protective location for dispensing seat covers	1	11.62ll)	11-235
Baby Changing Table	Fold out table for infant diaper care	1	11.62nn)	11-235

CONFIDENTIAL — DO NOT DISTRIBUTE

Figure 11-27: Key Features - Accessible Premium Bedroom (continued)

Feature	Short Description	Qty	Reference	Page
Seating Area Vanity	Unit with a desk, mirror and shelves. Located behind the seat.	1	11.62oo)	11-235
Full Length Mirror	Long mirror mounted on sidewall of restroom or cabinet	1	11.62qq)	11-236
Trash				
Seating Area Trash	Flip out storage for sleeper room trash	1	11.63a)	11-237
Restroom Trash	Storage for restroom related trash	1	11.63c)	11-237
Sanitary Waste	Storage location for used feminine hygiene products	1	11.63e)	11-238
Sharps Bin	Storage location for used needles and other medical waste	1	11.63f)	11-238
Storage				
Upper Cabinet	Storage location with a door	2	11.64c)	11-239
Lower Cabinet	Storage location with a door	1	11.64d)	11-239
Open Wardrobe	Open storage location with coat rod	1	11.64f)	11-240
Coat Hooks	Installed on partition wall, a maximum of 48" from the floor.	4	11.64h)	11-241
Carryon Luggage Storage	Storage cubby for carryon sized luggage	1	11.64i)	11-241
Under Seat Storage	Open space for carryon sized luggage	1	11.64j)	11-242
Seat Shelf	Additional storage shelf adjacent to seats in accessible room	1	11.64k)	11-243
Upper Cubby	Cubby adjacent to upper berth with outlet and ambient lighting	2	11.64l)	11-243
Seat Cubby	Three shelves near the berth for personal storage. Installed on either side of the seats.	2	11.64m)	11-243
Sidewall Cubby	Storage location in carshell side wall at the armrests.	2	11.64n)	11-243
High Storage Shelf	Storage shelf above 48" ADA reach	2	11.64p)	11-244
Restroom Crew Storage	Locker with square key for dedicated crew storage. Provide in cabin and restroom.	2	11.64r)	11-244

c). Functional Elements

i). Seat to Lower Berth Conversion

- (1) A simple unlatch mechanism is required to convert the seats into a lower bed/berth.
- (2) This should be positioned in a place that is easy for people to use and designed in a way so that people can understand its purpose.
- (3) The latch should be free for jamming and free from any finger trap hazards.
- (4) The position of the latch shall be ADA reach compliant.
- (5) Controls and operating mechanisms shall be operable with one hand and shall not require tight grasping, pinching, or twisting of the wrist.
- (6) There should be an assisted mechanism making it easy for ADA passengers of any ability to self-sufficiently and safely deploy and store the bed.
- (7) Conversion of seats to lower berth shall result in an entirely flat sleeping surface.
- (8) The mattress surface should be integral to the back of the seat.
- (9) A single seam between the bed surface is acceptable with a single thin topper will finish the bed surface.
- (10) There shall be no movement in the lower berth structure under full loading conditions when the lower berth is deployed.
- (11) A supplemental ottoman cushion shall be provided to cover the seat shelf and expand the length of the bed.
- (12) Design of the bed should allow people to sleep in both directions.
- (13) Any furnishings set above the bed surface must not present a hazard or head strike when using the bed.
- (14) Lower Berth Dimensions: Minimum width 28" x Minimum length 75"

ii). Deploying Upper Berth

- (1) The upper berth should be stored horizontally at the maximum height in the room.
- (2) When stowed, the upper berth should not block any part of the window or window removal in the event of an emergency.
- (3) Leading edges should be soft in form to minimize impact to any potential head strike.

- (4) The berth's stored height should be maximized so head clearance is at a maximum in both seated and standing positions.
 - (5) A simple and easy to use handle, latch, and lock mechanism should be within easy reach from a standing position.
 - (6) Successful locking should be visually indicated, and safety measures should be put in place to prevent accidental deployment and prevent misuse.
 - (7) The upper berth deployment should be free from jamming and racking and should lower slowly and in a controlled manner.
 - (8) Considerations should be made for assisted movement or counterbalances to assist people moving the upper berth down and back up into the stowed position.
 - (9) Mitigation should be made to avoid finger traps across any mechanism, rails, or support structures.
 - (10) Upper Berth Dimensions: Minimum width 27" x Minimum length 77"
- d). Accessibility Features
- i). 39" Room Door
 - (1) Access to the room will be subject to review and mockup user testing. Room doors should be and automatic sliding door.
 - (2) The door shall also be able to operate in a manual mode in the event of power loss or malfunction so that the room is not put out of service due to door operation failure.
 - ii). Handrail Locations
 - (1) Horizontal Handrails:
 - (a) ADA compliant horizontal handrails positioned to assist transfer through the sleeper room shall be provided.
 - (b) The handrail should be positioned to maximize the space between the room features while providing maximum access and support for passengers.
 - (i) Adjacent to aisle side seat
 - (ii) Adjacent to window side seat
 - (iii) On the cabinet near the door threshold
 - (iv) Adjacent to bed along partition wall and above mattress
 - (v) Along the underside of the window

- (vi) Shower handrail along 3 walls of restroom
- (2) Vertical Handrails
 - (a) ADA compliant vertical handrails positioned to assist transfer through the sleeper room shall be provided.
 - (b) The handrail should be positioned to maximize the space between the room features while providing maximum access and support for passengers.
 - (i) Either side of restroom door
 - (ii) Adjacent to toilet
 - (iii) Inside restroom adjacent to door
- iii). Control Buttons
 - (1) Room Door
 - (a) The controls for the room door must be ADA compliant in position, size, and configuration.
 - (i) Door Open/Close
 - (ii) Door Lock
 - (b) The buttons should be easy and intuitive to use.
 - (c) An accessible manual lock should be included with an indicator to show lock condition.
 - (d) The buttons should have visual and haptic feedback.
 - (e) Dimensions, position, and usability will be subject to Amtrak approval during mockup review:
 - (i) Note this review will include the disability community input.
 - (2) Restroom and shower room doors
 - (a) The controls for the restroom and for the shower door shall have the same features as the room door.
 - (i) Door Open/Close
 - (ii) Door Lock
- iv). 60" Turning Circle
 - (1) A clear 60" turning circle should be provided inside the room when the seats are in an upright position.

- (2) Turning circle shall be clear when fold out table and tip up seats are deployed.
 - (3) Alternatively, an ADA T maneuver space shall be available when the bed is deployed.
- v). Adjustable Features with Clearances
 - (1) Tip up seat
 - (2) Fold out table
 - (a) Two separate fold out tables should be positioned so when deployed should be clear of an RVAAC accessible space and an ADA accessible space.
- vi). Accessible Spaces for Wheeled Mobility Devices
 - (1) A clear accessible space of 59" x 32":
 - (a) This shall be provided inside the room when the seats are in an upright position.
 - (2) An RVACC accessible space of 59" x 32" shall be provided in each of the following locations:
 - (a) Beside the bed for storing a wheeled mobility device.
 - (b) In front of the restroom sink.
 - (c) Next to the toilet seat for storing a wheeled mobility device.
 - (d) Next to the shower seat for storing a wheeled mobility device.
- e). Lighting
 - i). General
 - (1) Unlike other sleeper cabins, the points below are not accompanied with diagram to show approximate lighting locations and types.
 - (2) Instead, the Contractor shall propose lighting locations at the PDR stage for Amtrak approval.
 - ii). Wash Lights (RGB Lights)
 - (1) Wall wash lights for the aisle partition wall and the back walls behind the seats shall be provided along the length of each wall.
 - (2) Ceiling wash lights shall run the length of the room along the window line.

- (3) This light shall function to illuminate the underside of the upper berth when stored and to illuminate the ceiling when the upper berth is deployed.
- iii). LED Panel Spot Lights (White Lights)
 - (1) Two small circular LED light panels shall act as spot lights near the entrance door.
 - (2) The frame for the spot lights shall be color matched to the ceiling.
- iv). Compartment Lights (RGB Lights)
 - (1) Lower Cubby shall have a strip of indirect lighting to illuminate this cubby under the ottoman and the inside of the luggage storage area.
 - (2) Side wall cubbies shall have a strip of indirect lighting to illuminate each cubby. This includes the sidewall and bottle holding cubbies.
 - (3) Under Seat lights shall be provided as indirect lighting that spills out across the floor under the seat.
- v). Shelf Strip Light
 - (1) Each shelf shall have an indirect strip light that washes from the underside of each shelf above.
 - (2) This includes all storage cubby shelves, the seat shelf, and the high storage shelf.
- vi). Reading Light (White Lights)
 - (1) Lower reading lights shall be provided at each seated position.
 - (2) The light itself shall be adjustable so that the passenger can adjust the direction to position the light over their reading material.
 - (3) Reading light switches should be located next to the reading light.
 - (4) A corner lamp shall wash indirect light both up and down.
 - (5) The switch for this light shall be located next to the lamp.
 - (6) Three of these lamps shall be provided in the Accessible Double.
- vii). Ceiling Lighting (White Lights)
 - (1) A feature pool light shall be central to the ceiling.
 - (2) This shall provide indirect wall washing across the ceiling at the center of the room.
- viii). Restroom Lighting (RGB Lights)

- (1) A back wall wash light shall be mounted to the towel shelf and provide both up and down wall washing lighting.
 - (2) This shall only activate when the door to the restroom is locked.
 - (3) A LED spot light shall be located on the ceiling above the toilet and adjacent to the rain shower.
 - (a) This shall only activate when the door to the restroom is locked.
 - (b) This light shall be a white only light.
- ix). Floor Lights
- (1) Lights shall be provided as indirect lighting that spills out across the floor under the sink counter.
- x). Sink Wash Light
- (1) A wash light should be used to light the sink area indirectly.
 - (2) This light shall only be activated when the door to the restroom is locked.
- xi). Crew Storage Cabinet Light
- (1) Cabinet shall include an internal light source that activates when the door is opened.
- xii). Mirror Light
- (1) A rounded LED light shall illuminate the mirror around the boarder.
 - (2) This light shall only be activated when the door to the restroom is locked.
- xiii). Baby Changing Table Light
- (1) Indirect lighting shall wash down the baby changing wall when the changing table is deployed.
 - (2) Angle and brightness of light shall be approved by Amtrak during mockup review.
 - (3) The design shall make efforts to avoid accidental direct light to the eyes of a baby on the changing table.

11.55 Sleeper Cabin Restrooms

- a). The restrooms for sleeper cabin passengers shall be identical in every way to the STR restrooms in coach.

11.56 Sleeper Cabin Showers

a). General

- i). To the extent possible equipment, parts, and features in the shower shall be identical to equipment, parts, and features in the showers for sleeper cabins.
 - (1) The intent of this clause is to minimize spares and maintenance techniques.
- ii). The general requirements for a restroom included in Section 11.44 apply to this section as well.
- iii). Please refer to Chapter 1 for information regarding quantity of this accommodation type desired across the trainset and suggested layouts.
- iv). To the extent possible, the Contractor shall adhere to the general arrangement images for the shower as shown in Figure 11-118 on page 11-377.

v). Modular Design

- (1) The shower shall have the ability to be used in other orientations provided that the same amenities are provided within a similar footprint. (see Figure 11-117 on page 11-376).
- (2) A modular design that allows different door positions should provide flexibility for the layout of the interior architecture.
- (3) The orientation should always prioritize passenger accommodation numbers where possible, while providing options for better aisle access in other instances.

b). Key Features

- i). A comprehensive list of expected features in the sleeper cabin showers is provided in Figure 11-28 and described in detail below.

Figure 11-28: Key Features - Sleeper Cabin Shower

Feature	Short Description	Qty	Reference	Page
General Items				
Standard Sleeper Cabin Shower Room Door	Bifold door for entrance into Shower	1	11.58g)	11-205
Fixed Glass Shower Panel	Safety glass panel	1	11.58h)	11-206
Sink Outlet	120V GFCI outlet near sink	1	11.58o)	11-208
Restroom Grab Bars	49 CFR 38.115 compliant handrails	2	11.58u)	11-210
Communications				
Emergency Call Button	Buttons in accessible locations that activate PEI	2	11.59b)	11-210
PEI - Intercom only	Speaker for emergency conversations	1	11.59d)	11-211
Personal Care				
Solid Surface Sink	Solid surface sink counter and basin	1	11.62c)	11-224
Sink Vanity Mirror	Mirror for passenger to look while washing hands	1	11.62f)	11-226
Under Sink Cover	Access cover panel for sink piping	1	11.62i)	11-228
Hand Dryer	Automatic hand dryer and paper towel dispenser	1	11.62m)	11-228
Shower Door	Bifold safety glass door for entrance into shower	1	11.62o)	11-229
Shower Seat	Seating platform in shower	1	11.62q)	11-229
Rain Shower	Shower head mounted on the ceiling	1	11.62r)	11-229
Adjustable Shower Head	Handheld shower head	1	11.62s)	11-230
Shower Control	Adjustment for water pressure and temperature in the shower	1	11.62t)	11-230
Shower Drain	Drain location for shower	1	11.62u)	11-230
Shower Exhaust	Adjustable exhaust grille	1	11.62v)	11-230
Soap Dish	Storage location for personal soap items in shower	1	11.62w)	11-231
Soap Dispensing Bottles	Refillable soap, conditioner, and lotion bottles mounted on wall	3	11.62x)	11-231
High Capacity Bath Towel Storage	Storage cabinet with door	1	11.62bb)	11-232
High Capacity Hand Towel Storage	Storage cabinet with door	1	11.62cc)	11-232
High Capacity Towel Bin	Open bin for used towels	1	11.62dd)	11-232
Towel Hooks	Inside the shower for hanging wash cloths or wash bags	2	11.62y)	11-231

CONFIDENTIAL — DO NOT DISTRIBUTE

Changing Area	Dry location within shower room for getting dressed	1	11.62ee)	11-232
Changing Area Bench	Seating platform in changing area	1	11.62ff)	11-232
Changing Area Mirror	Long mirror mounted on sidewall of restroom or cabinet	1	11.62gg)	11-232
Trash				
Sleeper Cabin Shower Room Trash	Storage for restroom related trash	1	11.63d)	11-238
Storage				
Restroom Crew Storage	Locker with square key for dedicated crew storage	1	11.64r)	11-244
Coat Hooks	Installed on the partition wall	2	11.64h)	11-241

- c). Additional Equipment Requirements
 - i). HVAC
 - (1) Supply Air Diffusers
 - (a) Conditioned air is delivered to the room via two (2) supply air diffusers with adjustable air flow control and located on the windowsill of the outside window.
 - (2) Exhaust Grille
 - (a) Exhaust air is removed from the room via the exhaust air grille which is located at the upper portion of the module.
 - ii). Electrical
 - (1) Detailed electrical requirements can be found in Chapter 15.
 - (2) Outlets
 - (a) Outlet to be provided near the crew storage and the sink. (see Figure 11-120 on page 11-379)
 - iii). Lighting
 - (1) General
 - (a) General lighting information is described below. Detailed lighting information can be found in Chapter 13.
 - (b) All lighting part numbers, manufacturers, and temperatures shall be proposed by the Contractor and approved at Amtrak after the lighting simulation during the design review process.
 - (2) Wash Light- RGB Lights
 - (a) Changing Area Wall
 - (i) Indirect mood light on to the back wall from the underside of the mirror or wall trim shall be provided.
 - (ii) This shall be activated only when the door is locked from the inside.
 - (b) Shower Wall
 - (i) Indirect mood light along the full length of the shower wall shall be provided.
 - (ii) This shall be activated only when the door is locked from the inside

- (c) Changing Bench
 - (i) Indirect mood light on to the floor from the underside of the bench shall be provided.
 - (ii) This shall be activated only when the door is locked from the inside
- (3) Main Ceiling Light- White Light
 - (a) A large rectangular LED panel in the ceiling provides the main source of light for the room.
- (4) Spot Light- White Lights
 - (a) Small circular LED light panels act as spot lights to provide the master lighting conditions for this room - frame to be color matched.
 - (b) At least one in the changing area and at least one in the shower enclosure.
 - (c) Position, number and style to be approved by Amtrak during the design review process.
- (5) Compartment Light- RGB Lights
 - (a) Floor Light
 - (i) Lights shall be provided as indirect lighting that spills out across the floor under the sink counter.
 - (b) Sink Light
 - (i) A wash light should be used to light the sink area indirectly. This light shall only be activated when the door to the restroom is locked.
 - (c) Storage Cabinet Light
 - (i) Cabinet shall include an internal light source that activates when the door is opened.
 - (d) Mirror
 - (i) A rounded LED light shall illuminate the mirror around the boarder.
 - (ii) This light shall only be activated when the door to the restroom is locked.
 - (iii) See Figure 11-119 on page 11-378.

- iv). Communications
 - (1) Speaker- PA speaker shall be located on the central ceiling panel.
 - (2) The PA speaker shall have an associated mute button.
 - (3) The speaker used in this location shall be identical to PA speakers used in other locations in the trainset for ease of maintenance and replacement.
 - (4) All communications equipment shall meet the requirements in Chapter 14.
- v). Emergency Equipment
 - (1) Smoke Detector
 - (a) Smoke Detectors shall be mounted on the central ceiling panel.
 - (b) The smoke detector used in this location shall be identical to the smoke detectors used in other locations in the trainset for ease of maintenance and replacement.
 - (2) Security
 - (a) Many items within the coach area will need to be secured.
 - (b) The following items are identified with specific locking preferences.
 - (c) Any other locking or security items will be discussed with Amtrak during design reviews.
 - (i) Shower Door Locking Mechanism
- d). CMF
 - i). Please refer to the attached CMF document (Exhibit F-2) for exact color, material, and finishes desired in this restroom area. Please also refer to Chapter 19.

11.57 Sleeper Cabin CMF

- a). Please refer to the attached CMF document (Exhibit F-2) for exact color, material, and finishes desired in this sleeper cabin area. Please also refer to Chapter 19.
- b). Wall Panels
 - i). Sidewall Panels along the carshell wall shall be made from molded thermoplastic with an easy to clean surface finish.
 - ii). Partition Walls shall be created from a composite structure such as aluminum honeycomb or HPL skinned honeycomb panels.

- iii). The finish of the wall and material of the outside skin shall be inspired by the CMF document (Exhibit F-2) and meet all structural requirements for crashworthiness based on mounting and attached loads to the panel.
 - iv). Noise cancelling or sound proofing features shall be implemented into the construction of all wall panels for each sleeper cabin.
 - v). The noise reduction can come from acoustic dampening panels, foams, or other technology.
 - vi). The noises from adjoining compartments, hallways, and machinery shall be dampened to at least 65 dBA.
- c). Ceilings
- i). Ceiling shall be created from a composite structure such as aluminum honeycomb or HPL skinned honeycomb panels.
 - ii). The finish of the passenger facing side of the ceiling panel and material of the outside skin shall be inspired by the CMF document (Exhibit F-2) and meet all structural requirements for crashworthiness based on mounting and attached loads to the panel.
 - iii). The finish of the material on the non-passenger facing side shall be coated such that there is no risk of corrosion from moisture from steam or humidity within the car.
- d). Flooring
- i). Flooring within the sleeper cabin shall be made from carpet.
 - ii). Flooring will be durable to withstand spills, leaks, and all methods of cleaning. Flooring shall also not become frequently damaged or worn.
 - iii). Flooring shall have enough give to prevent fatigue from standing.

Part IX: Sleeper Cabin Key Features

11.58 Sleeper Cabin Key Features - General

- a). Cabin Door - Standard Sleeper Cabin
 - i). Applicability: Roomette, SoloSuite, Club Bedroom, Premium Bedroom, Crew Sleeper Cabin, and the Lactation Room.
 - ii). Sliding Door
 - (1) A sliding door shall be provided for access to the room.
 - (2) The door shall not rattle and shall allow smooth sliding operation.
 - (3) Measures should be made to prevent any delamination of finish and surface finish protected by runners or guides.
 - (4) The door should be free from jamming.
 - (5) Door shall be manually operated.
 - (6) Clear Opening dimension of the door shall be maximized and shall not be less than 24" wide.
 - iii). Sliding Door Window
 - (1) Windows shall be included in the cabin doors to provide natural light and enhance the spaciousness of the room.
 - (2) Windows shall be made of safety glass, each ¼" thick
 - (3) They shall have a minimum width of 21" and shall be long enough that the lower portion of the window is not more than 18" from the floor.
 - (4) The door window shall be removable from either side using a pry-out rubber zip strip as an emergency escape route should the door be jammed closed.
 - iv). Sliding Door Window Blind
 - (1) An integrated blackout blind for the window in the door shall be provided.
 - (2) The blind shall be manually operated by the passenger.
 - (3) Blinds shall be able to be replaced within a 30 min timespan.
 - (4) In the accessible rooms (Accessible Twin, Accessible Double and Accessible Premium Bedroom) an option shall be included for automatic pushbutton operation.
 - v). Sliding Door Lock

- (1) Electronic Lock
 - (a) An electronic door locking mechanism shall be implemented into the door.
 - (b) This locking mechanism shall default to the unlocked position with loss of power as a safety feature.
 - (c) The locking mechanism shall allow for keyless and keycard entry through the use of RFID or Bluetooth technology.
- (2) Manual Lock
 - (a) Additionally, an accessible, stainless-steel, manual lock shall be mounted to the inside of the sliding door with an indicator to show lock condition.
 - (b) The lock shall engage with a stainless-steel mechanism in the partition wall of the sleeper cabin.
- vi). Sliding Door Handle
 - (1) Stainless-steel door handles shall be provided in the sliding door.
 - (2) They shall be positioned to slide door easily from a standing position for a 5th percentile female and a 95th percentile male.
 - (3) The door handle shall be recessed into the door.
- b). Cabin Door - Accessible Sleeper
 - i). Applicability: Accessible Twin, Accessible Double, Accessible Premium Bedroom
 - ii). The Accessible Sleeper Cabin Door shall meet all requirements of the Standard Sleeper Cabin Door, except for the following:
 - (1) Door Operating Mode: Automatic with manual back up
 - (2) Clear Opening shall not be less than 39" wide.
- c). Cabin Door Controls - Accessible Sleeper
 - i). Applicability: Accessible Twin, Accessible Double, Accessible Premium Bedroom
 - ii). The controls for the room door must be ADA compliant in position, size, and configuration.
 - (1) Door Open/Close
 - (2) Door Lock

- iii). The buttons should be easy and intuitive to use.
- iv). An accessible manual lock should be included with an indicator to show lock condition.
- v). The buttons should have visual and haptic feedback.
- vi). Dimensions, position, and usability will be subject to Amtrak approval during mockup review.
 - (1) Note this review will include the disability community input.
- d). Cabin Restroom Door - Standard Sleeper
 - i). Applicability: Club Bedroom and Premium Bedroom
 - ii). The door should open inwards as a bifold door, similar to an airline toilet door.
 - iii). The door should be sealed to prevent shower water escaping into the internal living space of the room, even when water is sprayed directly onto the back surface of the door.
 - iv). To keep the room carpet dry, a "water deflector" shall be provided on the inside of the door at the bottom to direct any water running down the door into the floor drain, rather than onto the threshold.
 - v). The door should lock from the inside, with an indicator on the outside showing the door lock status.
 - (1) Sleeper Cabin Shower: An instruction, in accordance with Amtrak Specification # 697, located on the interior side of the door, shall provide lock operating instructions.
 - vi). The clear width door opening shall be a minimum of 24".
 - vii). The door shall be of lightweight construction, consistent with durability and consistent appearance with the shower module and be secured with stainless-steel hinges.
 - viii). The door shall be free from resonance and rattles when in the closed position when the train is in motion at any permissible speed.
 - ix). The door frame and attachment of the keeper shall be sufficiently rigid so that it does not flex when the door closes, even if it is slammed; the intention is that this interface does not deteriorate over the life of the car.
 - x). Likewise, interior door construction shall incorporate interior stiffening in the area where the lock/ latch is attached to the door, so that the fasteners securing it to the leaf have a solid surface on which to clamp.

- x). The door latch, with a handle on both sides of the door, shall engage automatically when the door moves towards a closed position, but the lock requires definite action to engage.
 - xii). The door shall remain in the fully closed position at any permissible train speed.
 - xiii). The lock shall be operable, in an emergency, from the outside with a standard Amtrak coach key.
 - xiv). An instruction, in accordance with Amtrak Specification # 697, located on the interior side of the door, shall provide lock operating instructions.
 - xv). A grille in the door shall provide a path for ventilation air to enter the room, and flush odors before being exhausted to the car's exterior.
- e). Restroom / Shower Room Door - Accessible Sleeper Cabin
- i). Applicability: Accessible Twin, Accessible Double, Accessible Premium Bedroom
 - ii). The Accessible Sleeper Cabin Restroom Door shall be an automatic sliding door; this can be achieved with two leaves.
 - iii). The door shall operate in manual mode as well so that the event of power loss does not prevent the use of the restroom.
 - iv). The door shall be positioned to create space for a T-maneuver when the door is open and the bed is deployed.
 - v). The clear width door opening shall be a minimum of 36".
 - vi). The door should be sealed to prevent shower water escaping into the internal living space of the room, even when water is sprayed directly onto the back surface of the door.
 - vii). To keep the room carpet dry, a "water deflector" shall be provided on the inside of the door at the bottom to direct any water running down the door into the floor drain, rather than onto the threshold.
 - viii). The door should lock from the inside, with an indicator on the outside showing the door lock status.
 - (1) Sleeper Cabin Shower: An instruction, in accordance with Amtrak Specification # 697, located on the interior side of the door, shall provide lock operating instructions.
 - ix). The door shall be of lightweight construction, consistent with durability and consistent appearance with the shower module and be secured with stainless-steel hinges.
 - x). The door shall be free from resonance and rattles when in the closed position when the train is in motion at any permissible speed.

- x). The door frame and attachment of the keeper shall be sufficiently rigid so that it does not flex when the door closes, even if it is slammed; the intention is that this interface does not deteriorate over the life of the car.
 - xii). Likewise, interior door construction shall incorporate interior stiffening in the area where the lock/ latch is attached to the door, so that the fasteners securing it to the leaf have a solid surface on which to clamp.
 - xiii). The door latch, with a handle on both sides of the door, shall engage automatically when the door moves towards a closed position, but the lock requires definite action to engage.
 - xiv). The door shall remain in the fully closed position at any permissible train speed.
 - xv). The lock shall be operable, in an emergency, from the outside with a standard Amtrak coach key.
 - xvi). An instruction, in accordance with Amtrak Specification # 697, located on the interior side of the door, shall provide lock operating instructions.
 - xvii). A grille in the door shall provide a path for ventilation air to enter the room, and flush odors before being exhausted to the car's exterior.
- f). Restroom/ Shower Room Door Controls - Accessible Sleeper Cabin
- i). Applicability: Accessible Twin, Accessible Double, Accessible Premium Bedroom
 - ii). The controls for the restroom door must be ADA compliant in position, size, and configuration.
 - (1) Door Open/Close
 - (2) Door Lock
 - iii). The buttons should be easy and intuitive to use.
 - iv). An accessible manual lock should be included with an indicator to show lock condition.
 - v). The buttons should have visual and haptic feedback.
 - vi). Dimensions, position, and usability will be subject to Amtrak approval.
 - (1) Note this review will include the disability community input.
- g). Shower Room Door - Standard Sleeper Cabin
- i). Applicability: Premium Bedroom, Sleeper Cabin Showers
 - ii). The door should open inwards as a bifold door, similar to an airline toilet door.

- iii). The shower door shall have the same features as the Standard Sleeper Cabin Restroom Door.
- h). Fixed Glass Shower Panel
 - i). Applicability: Sleeper Cabin Showers
 - ii). A fixed glazed panel made from safety glass should be used to keep the shower space open and bright.
 - iii). The lower portion can be solid to provide structure for the cantilever benches.
- i). Side Window
 - i). Applicability: All sleeper cabins
 - ii). Each window shall be an emergency exit window and rescue access window complying with 49 CFR 238.113 and 238.114.
 - iii). Windows in all sleeper cabins shall be of the same size, except for the windows in the SoloSuite.
 - iv). SoloSuite side windows shall be smaller than those in other sleeper cabins as the SoloSuite has a smaller length along the carshell wall.
- j). Side Window Blinds
 - i). Applicability: All sleeper cabins
 - ii). Two types of pull-down blinds shall be provided:
 - (1) An outside sunshade shall provide daytime protection
 - (2) A second inside blackout blind shall cut out all light and provide complete privacy.
 - iii). Each blind should work individually or in combination, so they provide two layers of shade.
 - iv). Blinds shall be designed for manual operation.
 - v). Blinds shall be able to be replaced within a 30 min timespan.
 - vi). An option for automatic blinds with push button operation shall be included in the Accessible Twin, Accessible Double, and Accessible Premium Bedroom.
- k). Skylight Window
 - i). Applicability: SoloSuite
 - ii). A skylight window shall be provided as an option in the SoloSuite.

- iii). Skylight windows in the SoloSuites shall be identical to the skylight windows described as an option in the coach area of the train.
- l). Skylight Window Blinds
 - i). Applicability: SoloSuite
 - ii). Two types of blinds shall be provided which shall include the same features as the Side Window Blinds, except that they shall be automated so that a passenger can deploy or retract the blinds from the Master Control Screen.
 - iii). Blinds shall be able to be replaced within a 30 min timespan.
- m). SoloSuite Room Divider
 - i). Applicability: SoloSuite
 - ii). General
 - (1) The divider must store away neatly into a pocket, wall, or ceiling and not protrude into the room.
 - (2) When stored the divider must be free from rattle and movement and be securely retained in its stowed position.
 - (3) The stored divider must not prevent the use of any other of the rooms features or obscure the window or skylight.
 - iii). Room Divider Dimensions
 - (1) The room opening created when moving the divider should allow seated passengers to see each other from a seated position.
 - (2) The opening should be as large as possible so joining rooms feel like a single space.
 - (3) The opening should be maximized and be a minimum of 35" x 35".
 - iv). Room Divider Locking Mechanism
 - (1) The divider must be securely locked in place with a visual indicator on both sides of the room to show that it is locked.
 - (2) A solution must be found to prevent one passenger opening the divider without the others permission, such as a double latch.
- n). SoloSuite Central Console
 - i). Applicability: SoloSuite
 - ii). A central console partition shall be provided to provide a location for foot-boxes for the facing SoloSuite pairs.

- o). Outlets
 - i). Applicability: All sleeper cabins, and Sleeper Cabin Showers
 - ii). There shall be a minimum number of duplex outlets in each cabin, as shown in Figure 11-29. This shall include:
 - (1) Seat Outlets
 - (a) Two duplex outlets with two USB sockets shall be provided for each seated passenger.
 - (b) The outlets shall be located above the armrest height and in easy reach of people while seated.
 - (2) Partition Wall Outlets
 - (a) Two duplex outlets with two USB sockets shall be provided on the aisle partition wall near the vanity.
 - (3) Sink Outlet
 - (a) A duplex 120VAC GFCI receptacle shall be located on a panel adjacent the sink, preferably located to keep it dry from splashes from the sink.

Figure 11-29: Minimum Outlets by Cabin Type

Cabin Type	Reference	Page	Duplex w/USB at Seat	Duplex w/USB at Partition	120VAC GFCI at Sink	Minimum Outlets
Roomette	Figure 11-69	11-328	2	2	1	5
SoloSuite	Figure 11-75	11-334	1	1	1	3
Club Bedroom	Figure 11-82	11-341	2	2	1	5
Premium Bedroom	Figure 11-91	11-350	4	3	1	8
Accessible Twin	Figure 11-100	11-359	4	2	1	7
Accessible Double	Figure 11-110	11-369	4	1	1	6
Accessible Premium Bedroom	none	none	4	3	1	8
Sleeper Cabin Showers	none	none			1	1
Crew Sleeper Cabin	Figure 11-127	11-385	2	1	1	4

- p). Master Light Switch(es)
 - i). Applicability: All sleeper cabins
 - ii). Master light switches shall be supplied at the following two locations near the door:
 - (1) At standing height
 - (2) At upper berth reach height (not required for SoloSuite or Premium Bedroom)
 - iii). The master light switches shall default to turn on a preset lighting condition and turn off all lights.
- q). Master Control Screen
 - i). Applicability: All sleeper cabins
 - ii). Master Control Screen shall be mounted to the aisle side wall of the sleeper cabin.
 - iii). This control screen should be positioned with easy access from a seated position.
 - iv). All mounting hardware shall not be visible, shall be tamper-proof, and easily accessed for maintenance.
 - v). The master control screen shall be 9" minimum, except that in the Premium Bedroom it shall be 12" minimum.
 - (1) Amtrak reserves the right to choose to make all master control screens identical, and thereby using a 9" screen in the Premium Bedroom.
 - vi). Functionality and spec of screen can be found in Chapter 14 and all accessibility features described in Chapter 26 shall be addressed.
- r). Master Thermostat Control
 - i). Applicability: All sleeper cabins
 - ii). A mechanical method of controlling the room temperature shall be mounted to the wall.
 - iii). It shall provide an override system for passengers who cannot use the master control screen to make adjustments.
- s). Floor Heat
 - i). Applicability: All sleeper cabins
 - ii). Floor heating elements shall be provided as specified in Chapter 10.

- t). Grab Bars - Standard
 - i). Applicability: All sleeper cabins
 - ii). Grab bar(s) shall be provided for a standing passenger to steady themselves against train motion.
 - iii). Bars shall be directly secured to car secondary structure or module structure.
 - iv). Grab bar shall meet the requirements in 49 CFR 38.115.
 - v). Grab bar positioning shall be subject to mockup testing and Amtrak approval.
- u). Grab Bars - Restroom
 - i). Applicability: Club Bedroom, Premium Bedroom, Accessible Twin, Accessible Double, Accessible Premium Bedroom, Sleeper Cabin Showers
 - ii). Stainless steel grab bars shall be provided on one side of the restroom to allow passengers to steady themselves against train motion while using the facility.
 - iii). Bars shall be directly secured to car secondary structure or module structure.
 - iv). These bars shall be anti-slip grab bars in accordance with Subpart F of 49 CFR Part 38.123 (a) (3).
 - v). Grab bar positioning shall be subject to mockup testing and Amtrak approval.

11.59 Sleeper Cabin Key Features - Communications

- a). Passenger Information Screen (PIS/OTIS)
 - i). Space should be provided for an additional passenger information screen in all accessible rooms.
 - ii). Electrical, diagnostic, and mechanical interfaces shall be provided to this area regardless of Amtrak's decision to provide a screen at this location.
 - iii). The screen provided shall be a minimum of 21".
- b). Attendant Call Button
 - i). Button in the room used to page the service attendant in non-emergency uses.
- c). Emergency Call Button

- i). Two waterproof Emergency Call Buttons shall interface with the Passenger Emergency Intercom (PEI) in the toilet room.
- ii). The Emergency Call Buttons provide better access for passengers if they are not able to reach the PEI unit.
 - (1) The Emergency Call buttons shall have illuminated and audible indications when actuated.
 - (2) One Emergency Call button shall be located within easy reach while seated on the toilet and not easily confused with the flush button or other controls
 - (3) A second button located within 12 inches from the floor or otherwise reachable for someone who has fallen.
 - (4) Placement of the buttons is subject to approval during design review.
- d). Passenger Emergency Intercom (PEI)
 - i). The PEI in the toilet room shall interface with the Emergency Call Buttons.
 - ii). The PEI and Emergency Call button arrangement, including the interfaces used between them, must maintain the same safety level and a standalone PEI.
 - iii). The PEI and Emergency Call Buttons must remain functional under any toilet module degraded mode condition.
 - iv). See Chapter 14 for additional details.

11.60 Sleeper Cabin Key Features - Seating Area / Lower Sleeping Berth / Bed

- a). Seats - Standard Sleeper Cabin
 - i). Applicability
 - (1) This shall be used in all sleeper cabins except the Premium Bedroom. This includes the: Roomette, SoloSuite, Club Bedroom, Accessible Twin, Accessible Double, Accessible Premium Bedroom, and Crew Sleeper Cabin.
 - ii). General
 - (1) Seats shall be optimized with strong consideration for safety, comfort, and longevity.
 - (2) Attachment of the seats shall meet requirements of APTA SS-C&S-016.
 - (3) Seats shall be mounted so that they can be readily removed for maintenance and/ or overhaul.

- (4) Seats shall be subject to full design review and testing, in accordance with the seat specification.
 - (5) The design will be subject to Amtrak approval.
 - (a) All seat dimensions, cushion shore hardness will be subject to mockup review and approval of Amtrak.
 - (6) Space under the seats should be easy to clean and maintain.
- iii). Seat
- (1) The Contractor shall install adjustable reclining sleeper seat(s).
 - (2) When folded down, the seat becomes the lower berth and shall require less than 10 lbf to configure.
 - (3) The seat shall be optimized to fill the available space with strong consideration for safety, comfort, and longevity.
 - (4) In accessible cabins the seat shall also be optimized to maximize clear floor area, aid wheeled mobility device transfer, and facilitate an accessible and self-sufficient bed deployment.
 - (5) The seat shall be supported from the side wall sleeper seat rail via a seat bracket on the outboard end and a suitable bracket attached to the floor structure on the inboard end.
- iv). Dimensions
- (1) Dimension of seats (between inside surface of armrests), cushions and headrests vary by car type, as shown in Figure 11-30.

Figure 11-30: Standard Sleeper Cabin Seat Widths

Sleeper Cabin Type	Minimum Seat Width*	Figure No	Figure on Page
Roomette	26"	Figure 11-67	11-326
SoloSuite	34"	Figure 11-74	11-333
Club Bedroom	48"	Figure 11-81	11-340
Accessible Twin	28"	Figure 11-99	11-358
Accessible Double	28"	Figure 11-109	11-368
Accessible Premium Bedroom	28"	(no figure)	(none)
Crew Sleeper Cabin	26"	Figure 11-126	11-384
* Width between inside surfaces of armrests/side pads.			

- v). Seat Movement
- (1) Applicability: SoloSuite

- (a) Seat shall track forward so customers can utilize the large central console table.
 - (b) The result will provide some recline for the seat.
 - (2) Applicability: Accessible Seats (Accessible Twin, Accessible Double, Accessible Premium Bedroom)
 - (a) The Contractor shall consider seat height adjustment for different transfer heights with a range between 17" and 25" from the floor.
- vi). Seat Pan
 - (1) Applicability: all sleeper cabin seats
 - (a) The seat pan should be profiled to maintain ingress and egress clearance (chamfered edge).
 - (b) This is a high wearing area of the seat surfaces in this area should be suitably designed to be durable and free from snagging or entrapment.
- vii). Headrest
 - (1) Seat headrest should be adjustable in height for the span of seated passenger heights from the 95th percentile male to the 5th percentile female.
 - (2) The headrest shall have adjustable wings that fold outwards to adjust the width of the headrest while also providing lateral support for the head while resting and sleeping in an upright seated position.
 - (3) Headrest dimensions shall match those of the associated seat.
- viii). Cushions
 - (1) Seat cushions should be contoured to aid seat comfort.
 - (2) Seat cushions shall provide ergonomic support in the following locations:
 - (a) lumbar,
 - (b) side bolsters,
 - (c) back support,
 - (d) seat back and
 - (e) seat pan pillowing.
 - (3) Dimensions shall match those of the associated seat.

- (4) Cushioning, seat trim, and detailing will be evaluated during the design review process.
 - (5) Final seat configuration and comfort shall be subject to Amtrak approval based on documentation and mockup information presented by the Contractor.
- ix). Side Pad
- (1) A soft seat side pad shall be located on the inside side of the seat (opposite the window-side armrest) to:
 - (a) balance the seat
 - (b) cushion the inside edge to soften joining panel work
 - (c) create a soft finish bumper around the bed when deployed.
 - (2) The side pad shall be provided on all Standard Sleeper Cabin Seats, with the exception of those in the SoloSuite which shall instead have a second armrest.
- b). Seats - Premium Sleeper Cabin
- i). Applicability: Premium Bedroom
 - ii). General
 - (1) Premium Sleeper Cabin seats shall be adjustable and rotating seats that are supported from a center pedestal connected to the seat rail using a suitable bracket attached to the floor structure.
 - (2) The seat structure should have the appearance of a pedestal seat and seat foot.
 - (a) If it is necessary to tie the seat to the sidewall then this should be done in a hidden way.
 - (b) Cantilevered alternatives will also be considered.
 - (3) Seats shall be optimized with strong consideration for safety, comfort, and longevity.
 - (4) Attachment of the seats shall meet requirements of APTA SS-C&S-016.
 - (5) Seats shall lock in at least 3 positions of rotation.
 - (6) Seats shall be mounted so that they can be readily removed for maintenance and/ or overhaul.
 - (7) Seats shall be subject to full design review and testing, in accordance with the seat specification.

- (8) The design will be subject to Amtrak approval.
 - (a) All seat dimensions, cushion shore hardness will be subject to mockup review and approval of Amtrak.
- (9) Space under the seats should be easy to clean and maintain.
- iii). Recline
 - (1) Seats shall have a spring mechanism for a recline of up to 10 degrees.
 - (2) It is acceptable that the seat achieves this with a rocking style mechanism much like an office chair and a handle to lock and unlock this feature.
- iv). Dimensions
 - (1) A minimum seat width between inside surfaces of armrests should be a minimum of 22" (see Figure 11-90 on page 11-349).
- v). Integrated Armrest
 - (1) A full and cushioned armrest of 2.5" width shall be provided on each side of the chair.
 - (2) The armrest should be of a suitable length for a 5th percentile female and a 95th percentile male seated passenger to rest their forearm on the cushioned section.
 - (3) Moving armrest shall be considered to accommodate larger passengers.
- vi). Cushions
 - (1) Seat cushions should be contoured to aid seat comfort.
 - (2) Seat cushions shall provide ergonomic support in the following locations:
 - (a) lumbar,
 - (b) side bolsters,
 - (c) back support,
 - (d) seat back and
 - (e) seat pan pillowing.
 - (3) Dimensions shall match those of the associated seat.
 - (4) Cushioning, seat trim, and detailing will be evaluated during the design review process.

- (5) Final seat configuration and comfort shall be subject to Amtrak approval based on documentation and mockup information presented by the Contractor.
- c). Seats - Tip Up
 - i). Applicability: Accessible Twin, Accessible Double, and Accessible Premium Bedroom
 - ii). Tip up seat should fold up flush with the side wall to provide a clear and unobstructed space for wheeled mobility devices.
 - iii). Spaces when folded should be durable and suitable to back a wheeled mobility device against.
 - iv). When deployed the seat should reveal a soft cushioned seat back and headrest so when deployed should have similar comfort levels as the other seats in the room.
 - v). The seat should be positioned to have good access to the fold out table with a minimum seat width of 21" and minimum seat pan depth of 19".
- d). Arm Rest - Standard Sleeper Cabin
 - i). Applicability: This shall be used in all sleeper cabins except the Premium Bedroom. This includes the: Roomette, SoloSuite, Club Bedroom, Accessible Twin, Accessible Double, Accessible Premium Bedroom, and Crew Sleeper Cabin.
 - ii). A full and cushioned armrest of 3.5" width shall be provided on the window side.
 - iii). The armrest should be of a suitable length for a 5th percentile female and a 95th percentile male seated passenger to rest their forearm on the cushioned section.
 - iv). It is acceptable for the armrest to be integrated or wrap over a sidewall shelf.
 - v). In SoloSuite only: An armrest shall be provided on both sides of the seat (window and interior sides) as this seat does not have a side pad.
- e). Armrest - Center
 - i). Applicability: Accessible Twin, Accessible Double, Accessible Premium Bedroom
 - ii). An additional full and cushioned armrest of 8" minimum should be provided between the two seats.
 - iii). The armrest should be of a suitable length for seated passengers to rest their forearm on the cushioned section.
 - iv). The armrest should be provision for two cup holders.

- (1) The through hole diameter should be a minimum of 3.5".
 - (2) The cup holders and surrounding area should be hardwearing and spill proof.
- f). Headboard - Standard Sleeper Cabin
- i). Applicability: This shall be used in all sleeper cabins except the Premium Bedroom. This includes the: Roomette, SoloSuite, Club Bedroom, Accessible Twin, Accessible Double, Accessible Premium Bedroom, and Crew Sleeper Cabin.
 - ii). The armrest and seat side pad should continue and connect to form a thin, soft headboard around the back of the seat when the bed for the lower berth is down.
 - iii). In SoloSuite only: The headboard shall be the same as the Standard Headboard, except that it shall be formed by the two armrests rather than an armrest and a side pad.
- g). Headboard - Premium Sleeper Cabin
- i). Applicability: Premium Bedroom only
 - ii). There should be a soft headboard positioned behind the bed extending up to a height of 47.5" above floor or so that there is 6" showing when the bed is in its lounge position.
- h). Ottoman - Crew Sleeper Cabin
- i). Applicability: Crew Sleeper Cabin
 - ii). A fixed ottoman should be provided opposite the seat.
 - iii). A foldable portion of the ottoman should fold up to complete the bed surface.
- i). Ottoman - SoloSuite
- i). Applicability: SoloSuite
 - ii). A fixed ottoman should be provided inside the SoloSuite foot-box.
 - iii). A foldable portion of the ottoman should fold up to complete the bed surface and down to provide some standing space when the main part of the bed is deployed.
 - iv). Cushions for the ottoman shall be supplied and match the comfort and quality of the seat cushions.
 - v). The area below the ottoman cushion shall also function as an area for trash storage. Please refer to the flip out trash bin for more information.
- j). Ottoman Table

- i). Applicability: SoloSuite
 - ii). The ottoman table should be large enough for face-to-face dining when the seat is tracked forward.
 - iii). This workstation table shall be 8.5" x 37.5" and include a fold out component to extend the table by 7.5" wide for a total extended measurement of 16" x 37.5".
 - iv). The folding leaf shall create extra knee and turnover space for sleeping passengers.
 - v). The leaf must not interfere with divider mechanism when folded back.
 - vi). The leaf should be easy to deploy and stow with an intuitive handle.
 - vii). This table shall conform to APTA PR-CS-S-018-13.
- k). Adjustable Bed / Lounger
- i). Applicability: Premium Bedroom
 - ii). An adjustable Queen size bed shall be provided in the center of the room.
 - iii). This bed should be able to transition between states when fully loaded with two passengers.
 - iv). The motorized queen bed controller shall report alerts and faults to the car diagnostic system. See Chapter 24 for additional information.
 - v). In the day configuration, the power assisted adjustable bed shall gently bend the mattress to a reclined position to create a 'lounger'.
 - vi). In the night configuration, the power assisted adjustable bed shall lay perfectly flat for a sleeping surface.
- l). Cup Holder
- i). Applicability: All sleeper cabins
 - ii). Cup holders shall be accessible from a seated positioning, easy to deploy, and intuitive to use.
 - iii). Cup holders should be able to fold out when in use and fold away discreetly.
 - iv). They should be made from stainless-steel, be self-supporting, and structurally sound.
 - v). The through hole diameter should be a minimum of 3.5" and with a landing area for the cup to sit of at least 4".
- m). Bottle Holder

- i). Applicability: SoloSuite, Club Bedroom, Accessible Twin, Accessible Double, Accessible Premium Double, and Crew Sleeper Cabin.
 - ii). A small cubby should be built into the side wall by the window.
 - iii). The bottle holding cubby should be suitable to house a 17-ounce water bottle with a diameter of 3".
 - iv). Bottle holders should have an open bottom or a clip out part so the bottom of the pockets can be easily cleaned if filled with trash.
 - v). Dimensions, position, and usability is subject to Amtrak approval during the mockup review.
- n). **Fold Out Table - Single Leaf**
- i). Applicability: This shall be used in all sleeper cabins except the Crew Sleeper Cabin. This includes the: Roomette, SoloSuite, Club Bedroom, the Premium Bedroom, Accessible Twin, Accessible Double, and Accessible Premium Bedroom.
 - ii). Table height should provide adequate knee clearance for seated passengers.
 - iii). The height from the floor to the surface of the table shall be between 27" and 29".
 - iv). The table should be easy to deploy and stow with an intuitive handle.
 - v). The table shall slide out to rest in a position that is usable from the seated position.
 - vi). The table in its stored position should not prevent the conversion of the seat to a bed or impact bed length.
 - vii). A single leaf table shall be stored and deployed from the side wall.
 - viii). The table shall support a 50lbf point load on the end of the table without damage.
 - ix). Table dimensions vary by sideboard, as listed in Figure 11-31.
 - x). Each table shall operate independently of the other.

Figure 11-31: Single Leaf Fold Out Table Dimensions

Sleeper Cabin Type	Minimum Usable Surface	Extends from Sidewall
Roomette	18" x 18"	20"
SoloSuite	12.5" x 22"	24"
Club Bedroom	18" x 26"	28"

Premium Bedroom	20" x 26"	28"
Accessible Twin	12" x 22"	24"
Accessible Double	12" x 22"	24"
Accessible Premium Bedroom	12" x 22"	24"

- o). Fold Out Table - Double Leaf Sliding
 - i). Applicability: Crew Sleeper Cabin
 - ii). Table height should provide adequate knee clearance for seated passengers.
 - iii). The height from the floor to the surface of the table shall be between 27" and 29".
 - iv). The table should be easy to deploy and stow with an intuitive handle.
 - v). The table shall slide out to rest in a position that is usable from the seated position.
 - vi). The table in its stored position should not prevent the conversion of the seat to a bed or impact bed length.
 - vii). A sliding table shall be provided that when stored is located above the ottoman.
 - viii). The table should have two leaves that fold on top of each other to reduce the length of the table in its stored position.
 - (1) This is so the table can easily be pushed away while still in use leaving space for a person to leave the room.
 - ix). The minimum dimensions of usable surface should be 28" x 20" and the table shall extend from the sidewall 20".
 - x). The stored table and table mechanism should not interfere with a person's legs, foot clearance while sleeping or using the ottoman.
 - xi). The table should lock in both stored and deployed position to prevent accidental movement and injury.
 - xii). There should be no finger traps.
 - xiii). The top leaf should be able to fold open and closed in any position (i.e. even when slid back over the ottoman)
 - xiv). The table shall have an intuitive locking mechanism integrated appropriately.

11.61 Sleeper Cabin Key Features - Upper Sleeping Berth

- a). Upper Berth

- i). Applicability: Roomette, Club Bedroom, Accessible Twin, Accessible Premium Bedroom.
 - ii). A pull-down upper berth with safety restraint shall be provided. The upper berth shall latch into the stored position and also be able to latch into the deployed position.
 - iii). This berth shall be stored in the horizontal position against the ceiling lining and shall be pulled down along a wall-mounted, stainless-steel track to be used as a sleeping berth.
 - iv). The berth height when deployed will be evaluated and judged carefully during the design review process.
 - v). The distance between the top of the mattress surface and the underside of the ceiling should be a minimum of 24".
 - vi). The seated area below the berth should still be usable by seated passengers when the upper berth is deployed.
 - vii). While restricted access to the area is expected, the area should still be well lit and tables and other amenities should not be restricted by a deployed berth bed.
 - viii). The access to the upper berth should be free from obstructions and snagging points to allow a person to climb onto the upper bunk freely and safely.
 - ix). There should be a minimum distance of 14" between the side of the bunk when deployed and the outer wall of the room to allow a clear route to the upper bunk.
 - x). Key dimensions and access to the upper berth will be subject to mockup testing and Amtrak approval.
 - xi). Upper berth restraint straps, that engage with the upper berth and the ceiling restraint shall be attached to module structure for strength.
 - xii). These should retract into the ceiling and be easily pulled down and click into place using an automatic locking retractor belt system (similar to a car seat belt system).
 - xiii). The upper berth shall be counter-balanced so that the total force to lift or lower the berth shall be 10 lbf. maximum.
 - xiv). The berth shall be subject to full design review and testing at the mockup review.
- b). Upper Berth Grab Bar
- i). Applicability: Roomette, Club Bedroom, Accessible Twin, Accessible Premium Bedroom

- ii). An upper berth grab bar, secured to module structure, shall be provided as a grab point for steadying passengers entering/ exiting the upper berth.
 - iii). Grab bar positioning will be subject to mockup testing and Amtrak approval.
 - iv). Grab bar shall meet the requirements in 49 CFR 38.115.
- c). Upper Berth Steps
- i). Applicability: Roomette, Club Bedroom
 - ii). Built-in steps shall be provided to allow passengers to enter/ exit the upper berth.
 - iii). Integrated steps should be built into the area beside the seat to allow people to safely transit to the upper berth.
 - (1) Roomette shall have at least two (2) steps
 - (2) Club Bedroom shall have at least three (3) steps.
 - iv). Step surfaces shall be free from trip hazards and have an anti-slip finish to the tread surfaces.
 - v). Steps shall be designed in such a way that the seat cushions, armrests, or any soft furnishings are protected and clear of tread surfaces.
 - vi). Design of this function shall be part of the mockup and be part of the preliminary design review.
- d). Upper Berth Ladder
- i). Applicability: Accessible Twin, Accessible Premium Bedroom
 - ii). The ladder shall be provided with an identified storage location.
 - iii). It should be durable and lightweight.
 - iv). It should not have any sharp corners or edges.
 - v). It must be intuitive to use and locate.
 - vi). The fixation method should be robust and easy to lock and unlock.
 - vii). Successful locking should be visually indicated, and safety measures should be put in place to prevent accidental unlatching and prevent misuse.
 - viii). The ladder should be usable in multiple positions based on user specific needs and preference.
 - ix). Each step should clearly contrast the floor and it should also have integrated battery powered lights for safe use during low level light conditions.

11.62 Sleeper Cabin Key Features - Personal Care

CONFIDENTIAL — DO NOT DISTRIBUTE

- a). Drink Station
 - i). Applicability: Premium Bedroom, Accessible Premium Bedroom
 - ii). An area should be provided for a hot drinks station with appropriate water and power supplies.
 - iii). Space should also be provided for coffee pods, tea, sugar, and other associated amenities.
 - iv). Electrical, water, and mechanical provisions shall be provided in this location for mounting of a small coffee maker.

- b). Sink - Fold Out Style
 - i). Applicability: Roomette, SoloSuite, and Crew Sleeper Cabin
 - ii). General
 - (1) A fold-down stainless-steel sink with hot and cold water shall be provided for roomette passengers.
 - (2) The retractable pins on which the sink pivots shall engage stainless steel "keepers", securely fastened to the recess housing, and remain secure for the life of the car.
 - (3) When not in use, the sink shall be retained in the up position through the use of an approved ¼ turn tab-type latch, pressing against a metal area of the sink.
 - (4) An easy to clean, captive stainless-steel screen shall be provided over the sink drain cavity behind/ below the sink to catch items that might be inadvertently left on the sink surface before closing and would otherwise be lost down the drain.
 - (5) The design of the sink hinge shall allow removal of the sink and its re-installation to be done in a maximum of one minute.
 - (6) The ability to do this, as well as interchangeability of 3 replacement sinks shall be demonstrated in room FAI.
 - iii). Fold Out Sink Basin
 - (1) The sink basin shall have the minimum internal dimensions shown in Figure 11-32.
 - (a) The sink shall be lipped to prevent splashing from train motion.
 - (b) The sink shall have a 1/2 to 1 gallon capacity, be equipped with an overflow and shall be easily removable, without tools, for cleaning.
 - (c) The sink is drained through a nominal 1-1/4" diameter drain by the user by closing it back into its alcove.

Figure 11-32: Fold Out Sink Basin Minimum Internal Dimensions

Sleeper Cabin Type	Minimum Dimension		
	W	L	D
Roomette	8"	9.5"	3.7"
SoloSuite	14"	8"	3.7"
Crew Sleeper Cabin	8"	9.5"	3.7"

- iv). Fold Out Sink Faucet
 - (1) The faucet shall be mounted behind the sink in the sink alcove.
 - (2) The faucet shall use IR sensor to control water dispensing.
 - (3) Water flow from the faucet shall be directed into the sink and not splash the user.
- v). Fold Out Sink Open Indicator Light
 - (1) A red, wide viewing angle LED "Sink Open" indicator light shall illuminate when the sink is open, as sensed by a limit switch located in the sink alcove housing.
 - (2) This is to encourage the user to close the sink when it is left open.
 - (3) The switch shall be accessible for replacement.
- c). Sink - Solid Surface Style
 - i). Applicability: Club Bedroom, Premium Bedroom Accessible Twin, Accessible Double, Accessible Premium Bedroom, Sleeper Cabin Shower Room
 - ii). General
 - (1) A solid surface sink with hot and cold water faucet shall be provided.
 - (2) The sink countertop shall be made from solid surface material and shall include a marine edge, 6" backsplash, and 3/4" radius for cleanability.
 - (3) Note that all sink countertops shall be sloped toward the basin and drain.
 - iii). Sink Basin
 - (1) The sink basin shall have minimum internal dimensions of as shown in Figure 11-33.

Figure 11-33: Solid Surface Sink Basin Minimum Internal

Dimensions

Sleeper Cabin Type	Minimum Dimension		
	W	L	D
Club Bedroom	8"	11"	5"
Premium Bedroom	8"	11"	5"
Accessible Twin	15"	11"	5"
Accessible Double	15"	11"	5"
Accessible Premium Bedroom	15"	11"	5"
Sleeper Cabin Shower Room	18"	10"	5"

- (2) The sink shall have a 1/2 to 1 gallon capacity, be equipped with an overflow.
- (3) The sink is drained through a nominal 1-1/4" diameter drain.
- iv). Faucet
 - (1) The faucet shall be mounted behind the sink.
 - (2) The faucet shall use IR sensor to control water dispensing.
 - (3) Water flow from the faucet shall be directed into the sink and not splash the user.
- d). Sink Vanity Cabinet - Standard
 - i). Applicability: Roomette, SoloSuite, Club Bedroom, Premium Bedroom, and Crew Sleeper Cabin
 - ii). A vanity cabinet shall be located as shown in Figure 11-34.

Figure 11-34: Sink Vanity Cabinet Locations

Sleeper Cabin Type	Vanity Location
Roomette	Above sink, directly behind the mirror
SoloSuite	To be determined in design review
Club Bedroom	Above sink, directly behind the mirror
Premium Bedroom	Above sink, directly behind the mirror
Crew Sleeper Cabin	directly behind the mirror, in door of wardrobe

- iii). Contents
 - (1) Premium Bedroom
 - (a) The space within this cabinet shall be reserved for equipment for hand dryer and soap dispenser.

- (b) Any remaining volume should be accessible for customers.
- (2) Roomette, SoloSuite, Club Bedroom and Crew Sleeper Cabin
 - (a) The vanity shall provide a place for a passenger to place small toiletries.
 - (b) Additionally, Amtrak supplied towels and facecloths shall be provided and stored in this location as shown in Figure 11-35.

Figure 11-35: Compact Vanity Towel Capacity

Sleeper Cabin Type	Towel Storage Capacity
Roomette	2 hand towels 2 facecloths
SoloSuite	1 hand towel 1 facecloth
Club Bedroom	4 hand towels 4 facecloths
Crew Sleeper Cabin	1 hand towel 1 facecloth

- (c) This requires a shelf with retaining bar and a space for towels within the vanity cabinet with the minimum dimensions listed in Figure 11-36.

Figure 11-36: Compact Vanity Towel Shelf Minimum Dimensions

Sleeper Cabin Type	Minimum Dimensions
Roomette	7" x 11" x 14"
SoloSuite	5" x 12" x 10"
Club Bedroom	13" x 28" x 5"
Crew Sleeper Cabin	TBD in design review

- e). Sink Vanity Cabinet - Accessible
 - i). Applicability: Accessible Twin, Accessible Double, Accessible Premium Bedroom.
 - ii). A storage shelf with retaining bars within ADA accessible reach dimensions shall be included in the sink area.
- f). Sink Vanity Mirror

- i). The following described the over-sink mirror that shall be installed above the sink. This applies to mirrors over the fold-out sink (Roomette, SoloSuite and Crew Sleeper Cabin) and mirrors over the fixed sink in the restrooms (Club Bedroom, Premium Bedroom, Accessible Twin, Accessible Double, and Accessible Premium Bedroom)
- ii). A mirror constructed from safety glass shall be located above the sink.
- iii). This mirror on the front of the vanity unit should extend higher as a separate panel suitable for people to see their reflection while standing.
- iv). Minimum dimensions are as shown in Figure 11-37.

Figure 11-37: Over-Sink Mirror Minimum Dimensions

Sleeper Cabin Type	Minimum Mirror Dimensions
Roomette	10.5" x 30"
SoloSuite	12" x 39"
Club Bedroom	13" x 28"
Premium Bedroom	25" x 27.5"
Accessible Twin	25.5" x 25.5"
Accessible Double	26" x 26"
Accessible Premium Bedroom	design review
Sleeper Cabin Shower Room	18" x 33"
Crew Sleeper Cabin	design review

- v). The mirror area should be suitably lit and two concepts shall be presented at PDR, lighted perimeter and backlighted mirror.
- vi). Amtrak shall give guidance at the PDR and Mockup review for final mirror configuration.
- g). Sink Vanity Shelves - Standard
 - i). Applicability: Premium Bedroom
 - ii). Shelving shall be provided with suitable size to store a minimum of Amtrak supplied towels:
 - (1) 2 bath towels,
 - (2) 2 face cloths, and
 - (3) 2 hand towels.
 - iii). Space on the lower shelf should also be reserved for customer toiletries.
 - iv). These shelves shall be equipped with a retaining bar.
- h). Sink Vanity Shelves - Accessible

- i). Applicability: Accessible Premium Bedroom
- ii). A storage shelf with retaining bars within ADA accessible reach dimensions in shall be provided in the sink area.
- i). Under Sink Cover
 - i). Applicability: Sleeper Cabin Shower Room
 - ii). Sink pipe work and waster should be covered with a panel that is accessible for maintenance behind the towel bin.
- j). Hand soap Dispenser
 - i). Applicability: All sleeper cabins
 - ii). An automatic liquid soap dispenser which will accept a Celeste Industries liquid soap refill shall be installed and shall be located adjacent to the over-sink mirror.
- k). Lotion Bottle
 - i). A lotion bottle shall be provided near the sink.
- l). Towel Ring
 - i). Applicability: All sleeper cabins
 - ii). A stainless-steel combination towel ring/coat hook shall be provided.
 - iii). It shall be capable of supporting up to 25lbs each.
- m). Hand Dryer
 - i). Applicability: Club Bedroom, Premium Bedroom, Accessible Twin, Accessible Double, Accessible Premium Bedroom, Sleeper Cabin Showers
 - ii). A high velocity motion-activated hand dryer shall be mounted on the wall of near the sink in an easily accessible location.
- n). Restroom Wall Mirror
 - i). Applicability: Accessible Twin, Accessible Double
 - ii). A mirror constructed from Safety Glass shall be located on the restroom wall to the side of the sink.
 - iii). The mirror shall be suitable for people to see their reflection while standing.
 - iv). The mirror area shall be suitably lit; two concepts shall be presented at PDR: lighted perimeter and backlighted mirror.
 - v). Amtrak shall give guidance at the PDR and Mockup Review for final mirror configuration.

- o). Shower Door
 - i). Applicability: Premium Bedroom, Sleeper Cabin Showers
 - ii). The shower door shall be made from safety glass and shall be a bi-folding door.
 - iii). Sleeper Cabin Showers:
 - (1) The door should be sealed to prevent shower water escaping into the changing space of the room, even when water is sprayed directly onto the back surface of the door.

- p). Shower Curtain
 - i). Applicability: Accessible Twin, Accessible Double, Accessible Premium Bedroom
 - ii). A shower curtain should be provided to control water spread in the room while the shower is on.
 - iii). It should also provide a modesty screen for users.
 - iv). The curtain should be easy to deploy and stow with an intuitive handle.
 - v). The mechanism should be durable, free from jamming and racking.
 - vi). The design should meet abuse loads. Dimensions, position, and usability will be subject to Amtrak approval at the mockup review.

- q). Shower Seat
 - i). Applicability: Accessible Twin, Accessible Double, Accessible Premium Bedroom, Sleeper Cabin Showers
 - ii). A fold down shower seat shall be provided.
 - iii). Sleeper Cabin Shower Room:
 - (1) A fixed cantilevered shower seat should be provided inside the shower with an anti-slip finish with a minimum depth of 11.5" running the full width of the shower enclosure.

- r). Rain Shower
 - i). Applicability: Club Bedroom, Premium Bedroom, Accessible Twin, Accessible Double, Accessible Premium Bedroom, Sleeper Cabin Showers
 - ii). A rain shower in the ceiling provides a shower above head height.
 - iii). Rain shower should be seamlessly integrated into the ceiling in order to maximize head room in the restroom.

- s). Adjustable Shower Head
 - i). Applicability: Club Bedroom, Premium Bedroom, Accessible Twin, Accessible Double, Accessible Premium Bedroom, Sleeper Cabin Showers
 - ii). A commercial grade shower with hose-mounted wand and controls shall be provided.
 - iii). A shower hose clip shall also be provided.
- t). Shower Control
 - i). Applicability: Club Bedroom, Premium Bedroom, Accessible Twin, Accessible Double, Accessible Premium Bedroom, Sleeper Cabin Showers
 - ii). An on/off button and temperature control are located on the restroom wall close to the door.
 - iii). The shower control should prevent any accidental activation when using the toilet.
- u). Shower Drain
 - i). Applicability: Club Bedroom, Premium Bedroom, Accessible Twin, Accessible Double, Accessible Premium Bedroom, Sleeper Cabin Showers
 - ii). A round drain shall be provided in the shower stall to collect shower water.
 - iii). Shower water shall drain to the ground.
 - iv). The drain strainer shall be easily removable for cleaning.
 - v). Fasteners, if required shall be captive.
 - vi). The shower tray should be designed to prevent water from escaping into the main area of the room during train movement.
 - vii). Club Bedroom and Sleeper Cabin Showers:
 - (1) The restroom floor shall have a built-in shower tray with a raised lip.
 - (2) A slatted platform finishes flush with the top of the tray to allow the shower water to drain out underneath and prevent the floor remaining wet after use as a shower.
- v). Shower Exhaust
 - i). Applicability: Club Bedroom, Premium Bedroom, Accessible Twin, Accessible Double, Accessible Premium Bedroom, Sleeper Cabin Showers
 - ii). An exhaust grille shall be provided in the ceiling.
 - iii). Negative pressure in the restroom shall be provided by the HVAC system.

- w). Soap Dish
 - i). Applicability: Club Bedroom, Premium Bedroom, Accessible Twin, Accessible Double, Accessible Premium Bedroom, Sleeper Cabin Showers
 - ii). A self-draining soap dish with lip shall be provided in a convenient location to a seated or standing passenger in the shower.
- x). Soap Dispensing Bottles
 - i). Applicability: Club Bedroom, Premium Bedroom, Accessible Twin, Accessible Double, Accessible Premium Bedroom, Sleeper Cabin Showers
 - ii). Three refillable Amtrak bottles dispensing shampoo, conditioner and body wash shall be provided in the restroom.
- y). Towel Hook
 - i). Applicability: All sleeper cabins, Sleeper Cabin Showers
 - ii). Towel hooks shall be capable of supporting up to 25lbs each.
- z). Towel Rail
 - i). Applicability: Roomette, Premium Bedroom, Accessible Twin, Accessible Double, Accessible Premium Double
 - ii). A towel rail shall be made available for drying used towels.
 - iii). In the Premium Bedroom: The handrail adjacent to the toilet shall double as a grab handle and a towel rail.
- aa). Towel Storage - Standard
 - i). Applicability: Club Bedroom, Premium Bedroom, Accessible Twin, Accessible Double, Accessible Premium Bedroom
 - ii). A wall mounted formed towel holder of hotel quality shall be provided.
 - iii). The holder shall be stainless steel with capacity as shown in Figure 11-38.

Figure 11-38: Towel Storage Capacity by Cabin Type

Sleeper Cabin Type	Towel Storage Capacity
Roomette	n/a
SoloSuite	n/a
Club Bedroom	4 folded towels
Premium Bedroom	4 folded towels
Accessible Twin	2 of each type
Accessible Double	2 of each type
Accessible Premium Bedroom	2 of each type

Crew Sleeper Cabin	n/a
--------------------	-----

- iv). The shelf and towels are to be placed out of the direction of any shower water when the shower is in use.
- v). The shelf should be free from any potential head strike while using the shower or toilet.
- bb). Towel Storage - High Capacity Bath Towels
 - i). Applicability: Sleeper Cabin Shower Room
 - ii). A cupboard for storing a minimum of 15 clean Amtrak bath towels shall be provided.
- cc). Towel Storage - High Capacity Hand Towels
 - i). Applicability: Sleeper Cabin Shower Room
 - ii). Space should be provided on the vanity unit to stack hand towels and wash cloths.
- dd). High Capacity Towel Bin
 - i). Applicability: Sleeper Cabin Shower Room
 - ii). The space under the sink should be maximized for storing used towels with a minimum volume of 30 Gal.
 - iii). The bin should be lined, prevent water ingress and buildup of mold.
- ee). Changing Area
 - i). Applicability: Sleeper Cabin Shower Room
 - ii). The standing changing area in front of the changing bench should be a minimum of 24" x 30"
- ff). Changing Area Bench
 - i). Applicability: Sleeper Cabin Shower Room
 - ii). A cantilevered bench should be provided in the changing area with space kept free under the seat for a bag.
 - iii). The bench should have a minimum depth of 11.5" running the full width of the changing area.
- gg). Changing Area Mirror
 - i). Applicability: Sleeper Cabin Shower Room

- ii). A mirror constructed from safety glass shall be located above the changing bench.
 - iii). The mirror on the front of the vanity unit should extend higher as a separate panel suitable for people to see their reflection while standing.
 - iv). The mirror area should be suitably lit and two concepts shall be presented at PDR, lighted perimeter and backlighted mirror.
 - v). Amtrak shall give guidance at the PDR and Mockup review for final mirror configuration.
- hh). Toilet
- i). Applicability: Club Bedroom, Premium Bedroom, Accessible Twin, Accessible Double, Accessible Premium Double
 - ii). A toilet, complete with toilet bowl assembly, shroud, and overflow pan shall be provided in the restroom.
 - iii). Toilet Bowl Assembly
 - (1) A toilet stand with shroud assembly shall be located in the toilet room.
 - (2) Each restroom shall be equipped with a toilet bowl assembly, encased in the toilet shroud.
 - iv). Toilet Shroud
 - (1) The shape of the toilet shroud housing shall locate the toilet seat ergonomically for ease of use and comfort.
 - (2) The toilet shroud shall be constructed of FRP with gel coat color to match the restroom shell or of stainless steel, with brushed finish or approved alternate.
 - (3) Standard Shroud:
 - (a) Applicability: Club Bedroom, Premium Bedroom
 - (b) Sufficient foot room shall be provided. When seated, the user's legs shall not contact the shroud.
 - (4) Accessible Shroud
 - (a) Applicability: Accessible Twin, Accessible Double, Accessible Premium Double
 - (b) The form of the toilet is undercut at the bottom to maximize wheeled mobility device clearance.
 - v). Toilet Overflow Pan

- (1) The toilet bowl assembly shall be mounted on a stainless-steel overflow pan, which shall contain flooding should the toilet outlet become blocked or system leak.
 - (2) The overflow pan shall:
 - (a) be watertight with raised edges of ~2 inches height
 - (b) have the attachment points exterior to the pan
 - (c) Have all exposed edges folded for safety and to provide stiffness
 - (d) be equipped with an overflow tube
- ii). Toilet Seat
- i). Applicability: Club Bedroom, Premium Bedroom, Accessible Twin, Accessible Double, Accessible Premium Double
 - ii). A standard toilet seat and toilet lid shall be provided.
 - iii). Toilet seat and seat lid should all have soft close mechanisms.
 - iv). A white toilet seat with lid, meeting Amtrak specification # 352, shall be provided.
 - v). The toilet seat and cover shall be constructed of reinforced fiberglass or approved alternate.
 - vi). The lid and seat shall be stable in the up position regardless of train motion, including braking, to prevent it from slamming down suddenly against the shroud.
- jj). Toilet Flush Mechanism
- i). Applicability: Club Bedroom, Premium Bedroom, Accessible Twin, Accessible Double, Accessible Premium Double
 - ii). A two-button push flush shall be located on the back wall of the restroom above the toilet.
 - iii). This shall provide standard and eco flush options for the passenger.
 - iv). The flush mechanism shall also incorporate an automatic flushing feature when the passenger is done using the toilet.
- kk). Toilet Paper Dispenser
- i). Applicability: Club Bedroom, Premium Bedroom, Accessible Twin, Accessible Double, Accessible Premium Double
 - ii). A toilet paper dispenser shall be provided adjacent to the toilet.

- iii). This dispenser shall protect the toilet paper from getting wet when the restroom is used as a shower.
- ll). Toilet Seat Cover Dispenser
- i). Applicability: Club Bedroom, Premium Bedroom, Accessible Twin, Accessible Double, Accessible Premium Double
 - ii). A dispenser for paper toilet seat covers should be located by the toilet.
 - iii). This dispenser shall protect the toilet seat covers from getting wet when the restroom is used as a shower.
- mm). Shower Seat Cover
- i). Applicability: Club Bedroom
 - ii). The toilet seat shall be covered by a lid that covers the toilet seat and acts as a shower seat.
 - iii). The shower seat cover shall have a slow close mechanism.
 - iv). While the restroom is being used as a shower, the lid should disguise the toilet seat forming a bench across the width of the room.
 - v). The form of the toilet shall be undercut at the bottom to maximize standing space in the shower area.
 - vi). The design of the toilet, access and lid design will be subject to Amtrak approval during the mockup review.
- nn). Baby Changing Table
- i). Applicability: Accessible Twin, Accessible Double, Accessible Premium Double
 - ii). A baby changing table should be provided with an RVAAC compliant clear space in front of it.
 - iii). The changing table should be easy to deploy and stow with an intuitive handle.
 - iv). The mechanism should be durable, free from jamming and racking.
 - v). The design should meet abuse loads.
 - vi). It should have a soft opening mechanism.
- oo). Seating Area Vanity
- i). Applicability: Accessible Twin, Accessible Double, Accessible Premium Bedroom

- ii). Vanity Desk
 - (1) The desk shall include a slide out drawer mechanism to expand the workspace.
 - (2) The desk when extended shall provide a minimum workspace of 24" x 14".
- iii). Vanity Desk Mirror
 - (1) A 20" diameter, large circular mirror constructed from safety glass shall be located above the desk.
 - (2) The mirror shall have integrated lighting.
 - (3) The bottom of the reflective surface shall be a maximum of 40" above the finish floor.
 - (4) Dimensions, position, and usability will be subject to Amtrak approval during the mockup review.
- iv). Vanity Shelf
 - (1) A fold out storage shelf with a retention bar shall be supplied in the vanity area.
 - (2) This should be separate from the main desk.
 - (3) When deployed, the shelf should be a minimum of 6" deep.
 - (4) A portion of the shelf should be able to store containers or bottles with a minimum dimension of 3" x 10".
- pp). Premium Restroom Mirror
 - i). Applicability: Premium Bedroom
 - ii). A large mirror shall be wall mounted and positioned opposite to the door.
 - iii). The mirror shall be at least 25" x 27.5" or otherwise approved by Amtrak.
 - iv). The mirror area should be suitably lit and two concepts shall be presented at PDR, lighted perimeter and backlighted mirror.
 - v). Amtrak shall give guidance at the PDR and Mockup review for final mirror configuration.
- qq). Full Length Mirror
 - i). Applicability: Premium Bedroom, Accessible Twin, Accessible Double, Accessible Premium Bedroom
 - ii). A full-length mirror shall be provided in addition to the over-sink mirror.

- iii). The bottom edge of the reflective surface shall be a maximum of 40" from the floor.

11.63 Sleeper Cabin Key Features - Trash

a). Trash Bin - Seating Area

- i). Applicability: Roomette, SoloSuite, Accessible Twin, Accessible Double, Accessible Premium Bedroom, Crew Sleeper Cabin
- ii). A "flip out" Trash Receptacle shall be provided in the room, at an Amtrak approved location.
- iii). The trash receptacle shall have a spring-loaded hinged door and be clearly labeled.
- iv). The operation and maintenance of the bin should not result in any snagging or finger traps.
- v). The bin should be watertight in case of a spill and shall prevent any water escapement.
- vi). The trash bin shall meet the requirements of Section 11.17: Trash and Recycling Storage

b). Trash Bin - Drink Station

- i). Applicability: Premium Bedroom
- ii). A trash bin should be provided below the drinks station.
- iii). The opening should be a minimum of 8" x 8" and closed with push flap or similar.
- iv). Access to the bin should be provided via a self-closing hinged door.
- v). The operation and maintenance of the bin should not result in any snagging or finger traps.
- vi). The bin should be watertight in case of a spill preventing any water escapement.
- vii). The trash bin shall meet the requirements of Section 11.17: Trash and Recycling Storage

c). Trash Bin - Restroom

- i). Applicability: Club Bedroom, Premium Bedroom, Accessible Twin, Accessible Double, Accessible Premium Bedroom
- ii). A trash storage area with accompanying trash bin shall be provided below the sink.

- iii). The trash bin shall meet the requirements of 0, and accommodate the volume indicated in Figure 11-1.
 - iv). The operation and maintenance of the trash flaps and bin should not result in any snagging or finger traps.
 - v). The bin should be watertight in case of a spill preventing any water escapement.
 - vi). for more information.
- d). Trash Bin - Sleeper Cabin Showers
- i). Applicability: Sleeper Cabin Showers
 - ii). A trash bin shall be provided under the sink with push flap cover.
 - iii). The minimum volume of trash for this receptacle shall be 14 gallons.
 - iv). The trash flap for this receptacle shall be a minimum of 10" x10".
- e). Sanitary Waste
- i). Applicability: Premium Bedroom, Accessible Twin, Accessible Double, Accessible Premium Bedroom
 - ii). A sanitary waste bin shall be provided to the right of the toilet complete with modesty flap.
- f). Sharps Bin
- i). Applicability: Premium Bedroom, Accessible Twin, Accessible Double, Accessible Premium Bedroom
 - ii). Provision for a sharps bin should be provided within the restroom.
 - iii). The size, position, and method of removal of sharps should be agreed and instructed by Amtrak.

11.64 Sleeper Cabin Key Features - Storage

- a). Cabinet
- i). Applicability: Roomette, Club Bedroom, Accessible Double
 - ii). A cabinet shall be provided for passenger personal item storage with dimensions no less than the minimum dimensions shown in Figure 11-39.

Figure 11-39: Cabinet Minimum Dimensions

Sleeper Cabin Type	Minimum Dimensions	Minimum Storage
Roomette	7" x 11" x 27.5"	
Club Bedroom	TBD in design review	
Accessible Double	9" x 29" x 39"	45 gallons

- iii). The cabinet shall include one shelf with retaining bars for clothes and personal items.
 - iv). An internal light shall be activated as the cabinet is opened.
 - v). The cabinet handle should be easy and intuitive to use.
 - vi). The lower portion of the cabinet within ADA compliant reach of a person in a seated position.
- b). Open Cabinet
- i). Applicability: Premium Bedroom
 - ii). A 3.5" x 33.5" x 22.5" (or similar volume as approved by Amtrak) open cabinet shall be provided for passenger personal item storage.
 - iii). The cabinet shall include at least two shelves with retaining bars for clothes and personal items.
 - iv). Outlets shall be provided in this location at the bottom shelf.
- c). Upper Cabinet
- i). Applicability: Accessible Twin, Accessible Premium Bedroom
 - ii). A cabinet shall be provided for passenger personal item storage.
 - (1) Accessible Twin Sleeper Cabin: The cabinet shall be 9" x 16" x 40" and offer a minimum of 26 gallons of storage.
 - iii). The cabinet shall include one shelf with retaining bars for clothes and personal items.
 - iv). An internal light shall be activated as cabinet is opened.
 - v). The cabinet handle should be easy and intuitive to use.
 - vi). The lower portion of the cabinet shall be within ADA compliant reach of a person in a seated position.
- d). Lower Cabinet

- i). Applicability: Accessible Twin, Accessible Premium Bedroom
 - ii). A cabinet shall be provided for passenger personal item storage.
 - (1) Accessible Twin Sleeper Cabin: The cabinet shall be 9" x 16" x 16"
 - iii). The cabinet shall include one shelf with retaining bars for clothes and personal items.
 - iv). An internal light shall be activated as cabinet is opened.
 - v). The cabinet shall provide storage volumes as follows:
 - (1) Accessible Twin Sleeper Cabin: 11 gallons of storage
 - (2) Accessible Premium Bedroom: 55 gallons of storage
 - vi). The cabinet handle should be easy and intuitive to use.
 - vii). The lower portion of the cabinet within ADA compliant reach of a person in a seated position.
- e). Wardrobe
- i). Applicability: Premium Bedroom, Crew Sleeper Cabin
 - ii). A shelved cabinet with retaining bars for clothes and personal items shall be provided as a wardrobe.
 - iii). The wardrobe should have provision for hanging clothes and be large enough to hang clothes on coat hangers.
 - iv). It should provide a minimum of 55 gallons of storage.
 - v). The cabinet door handle should be easy and intuitive to use.
 - vi). An internal light shall be activated as the door is opened.
- f). Open Wardrobe
- i). Applicability: Club Bedroom, Accessible Twin, Accessible Double, Accessible Premium Bedroom
 - ii). A dedicated space shall be allocated for an open wardrobe.
 - (1) Club Bedroom: It shall be located between the seat and the restroom, directly above the carryon storage cabinet.
 - iii). This area shall have a coat rod for hanging items and a retaining bar to hold personal items in the open wardrobe area.
- g). Crew Sleeper Cabin Wardrobe
- i). Applicability: Crew Sleeper Cabin

- ii). A large 12" x 43" x 25" wardrobe with a door should be provided with space to hang clothes on coat hangers.
- iii). It shall include coat hooks, a vanity, and mirror.
- iv). The vanity and mirror shall be integrated into the door of the wardrobe
- v). Coat Hooks
 - (1) Two coat hooks shall be provided in the open wardrobe area.
 - (2) Coat hooks shall have the same features as coat hooks in the roomette.
- vi). Vanity
 - (1) Directly behind the mirror shall be a vanity cabinet for a passenger to place small toiletries.
 - (2) Additionally, Amtrak supplied towels shall be provided and stored in this location: two hand towels and two facecloths.
- vii). Mirror
 - (1) A mirror constructed from safety glass shall be located above the sink.
 - (2) The mirror on the front of the vanity unit should extend higher as a separate panel suitable for people to see their reflection while standing.
 - (3) The mirror area should be suitably lit and two concepts shall be presented at PDR, lighted perimeter and backlighted mirror.
 - (4) Amtrak shall give guidance at the PDR and Mockup review for final mirror configuration.
- h). Coat Hooks
 - i). Applicability: All sleeper cabins, Sleeper Cabin Showers
 - ii). Coat hooks shall be capable of supporting up to 25lbs each.
 - iii). In accessible cabins the coat hooks shall be installed no more than 48" from the floor.
- i). Carryon Luggage Storage
 - i). Applicability: All sleeper cabins
 - ii). A space shall be dedicated for carryon-sized luggage storage.
 - iii). The space shall be located as follows:

Sleeper Cabin Type	Carryon Luggage Storage Location
Roomette	between seat and aisle partition wall
SoloSuite	overhead rack
Club Bedroom	between seat and restroom
Premium Bedroom	In shower partition wall
Accessible Twin	between seat and aisle partition wall
Accessible Double	between seat and aisle partition wall
Accessible Premium Bedroom	between seat and aisle partition wall
Crew Sleeper Cabin	between seat and aisle partition wall

- iv). Carryon luggage is defined as a bag with dimensions: 22" x 14" x 9".
- v). This area shall be protected from the seat area so luggage can be stored discretely.
- vi). This area shall be free from structure or protrusions that may interfere with luggage storage.
- vii). This area shall also be easy to clean.
- viii). In SoloSuite:
 - (1) The rack should be within easy reach for 5th percentile female passengers.
 - (2) The rack should be designed to prevent luggage falling off in typical railroad conditions i.e. with lip or retention strap.
 - (3) Skylight and blinds shall not be damaged from luggage that is placed in the overhead storage area.
- j). Underseat Storage
 - i). Applicability: All sleeper cabins, except Premium Bedroom
 - ii). Unobstructed luggage storage space for carryon sized luggage shall be provided under the seat, regardless of seat recline or seat/ berth mode.
 - iii). This area shall be free from structure or protrusions, including seat operating mechanisms, that may interfere with luggage storage.
 - iv). This area shall also be easy to clean.

- k). Seat Shelf
 - i). Applicability: Accessible Twin, Accessible Double, Accessible Premium Bedroom
 - ii). A shelf above the ottoman offers storage for the aisle partition wall side seat.
 - iii). The shelf should work when the berth is deployed.
 - iv). Usable dimensions of the shelf shall be 7" x 28".
 - v). The shelf should be ADA compliant when passengers are seated.
 - vi). A duplex outlet shall be mounted to the wall below the shelf.
- l). Upper Cubby
 - i). Applicability: Roomette, Club Bedroom, Accessible Twin, Accessible Premium Bedroom
 - ii). Two alcove cubbies shall be provided for storage of personal items - one on each side of the room.
 - iii). These cubbies shall be usable when the upper berth is stored and when it is deployed.
 - iv). Cubbies shall include lighting and act as a light well.
 - v). In addition, each cubby shall be equipped with duplex sockets and two USB sockets.
- m). Seat Cubby
 - i). Applicability: Accessible Double, Accessible Premium Bedroom
 - ii). On either side of the seats, 3-shelf cubbies shall be provided.
 - iii). Seat cubbies shall provide storage for personal items and shall be usable when the seat is used as a seat or deployed into a bed configuration.
 - iv). The lower-level cubbies shall be supplied with room lighting controls.
 - v). Cubbies shall be lit and acts as a light well with integrated lighting and equipped with 120 V duplex convenience outlets that include USB ports.
- n). Sidewall Cubby
 - i). Applicability: SoloSuite, Club Bedroom, Accessible Twin, Accessible Double, Accessible Premium Bedroom, Crew Sleeper Cabin
 - ii). One cubby in each arm rest shall be provided for personal items.
 - (1) In the Accessible Twin, Accessible Double, and Accessible Premium Bedroom, this shall be located next to the tip up seat.

- iii). This cubby shall include integrated low-level lighting.
 - iv). The cubby should be easy to clean and safe and intuitive to use.
 - v). Dimensions, position, and usability is subject to Amtrak approval during the mockup review.
- o). Bedside Cubby
- i). Applicability: Premium Bedroom
 - ii). On either side of the bed, 3-shelf cubbies shall be provided.
 - iii). Bedside cubbies shall provide storage for personal items and shall be usable when the adjustable bed is in either configuration.
 - iv). The lower-level cubbies shall be supplied with room lighting controls.
 - v). Cubbies shall be lit and acts as a light well with integrated lighting and equipped with 120 V duplex convenience outlets that include USB ports.
- p). High Storage Shelf
- i). Applicability: Accessible Twin, Accessible Double, Accessible Premium Bedroom
 - ii). A high level personal storage shelf for small items.
 - iii). A retention bar that prevents items from falling off shall be provided.
 - iv). Note: Currently the position is above 48" from floor so this is not ADA reach compliant but could be accessed by a passenger accompanying a passenger using a wheeled mobility device.
- q). Seating Area Crew Storage
- i). Applicability: Premium Bedroom, Accessible Double
 - ii). Crew storage spaces should be provided at tall heights in the room.
 - iii). These storage spaces shall include cabinets suitable for storage of toilet and shower amenities, spare towels, and face cloths.
 - iv). Crew storage shall be lockable with a square key.
- r). Restroom Crew Storage
- i). Applicability: Accessible Twin, Accessible Premium Bedroom, Sleeper Cabin Showers
 - ii). A crew storage cabinet shall be provided at high elevations in the restroom for storage of restroom, shower, and cleaning supplies.
 - iii). Crew storage shall be lockable with a square key.

- s). Safe Storage
 - i). Applicability: Premium Bedroom
 - ii). Below the wardrobe, a hotel style safe shall be provided for personal items.
 - iii). Electrical and mechanical provisions shall be provided in this location for mounting of a hotel-style storage safe.
- t). Linen Cabinet
 - i). Applicability: Crew Sleeper Cabin
 - ii). A 7" x 26" x 17" minimum cabinet shall be provided for passenger personal item storage.
 - iii). The cabinet shall include one shelf with retaining bars for bedding, towels, and clean linen.
 - iv). An internal light shall be activated as the cabinet is opened.
- u). Jacket Closet
 - i). Applicability: Crew Sleeper Cabin
 - ii). A 11" x 28" x 8" closet with a hanging space should be provided for outdoor jackets and coats.
 - iii). This cabinet shall be lined at the bottom with a base pan so that wet items can be stored in this area if necessary and it will be easy to wipe out and clean.
- v). Clothing Cabinet
 - i). Applicability: Crew Sleeper Cabin
 - ii). A 26" x 32" x 13" clothing cabinet shall be provided for crew members to store clothing and other personal items.
 - iii). This cabinet shall come with shelving and retaining bars to keep items in place while the train is in motion.
 - iv). The doors should be able to lock open and have a soft close mechanism.
 - v). The door that opens to the window should be able to be opened when the wardrobe is open as well.
- w). Drawers
 - i). Applicability: Crew Sleeper Cabin
 - ii). Two 12" x 6" x 25" drawers should be provided for crew clothing and other personal items.

- iii). The drawers should be a minimum of 6" deep. Drawers should be free from rattle and have a smooth sliding operation.
- iv). Drawers should have a soft closing mechanism; they should lock in stored position to prevent accidental opening and prevent injury.

11.65 Sleeper Cabin Integrated Systems

a). HVAC

- i). Supply air diffusers- Conditioned air is delivered to the room via 2 supply air diffusers with adjustable air flow control and located on the windowsill of the outside window.
- ii). Exhaust grille- Exhaust air is removed from the room via the exhaust air grille which is located at the upper portion of the module.
- iii). Air circulation fans- Air circulation fans with controls shall be provided at the head of each sleeping berth. The purpose is to stir room air and decrease the potential for temperature differential between upper and lower areas of the room especially when the upper berth is down. The air circulation fans shall have manual adjustment of the airflow direction.

b). Communications

i). Speaker

- (1) PA speaker shall be located on the central ceiling panel.
- (2) The PA speaker shall have an associated mute button.
- (3) The PA speaker shall have an associated mute button.
- (4) The speaker used in this location shall be identical to PA speakers used in other locations in the trainset for ease of maintenance and replacement.

ii). Master Control Panel

- (1) A 9" touchscreen control panel shall be provided in each sleeper cabin. The purpose of this control panel is to adjust lighting, temperatures, and other settings within the sleeper cabin. In addition, the features for this control panel may extend into the ability to set notifications, text announcements, or page the attendant.
- (2) The details of the master control panel are located in Chapter 14.

iii). Attendant Call Button

- (1) An attendant call button shall be located within each room.
- (2) The intention of this call button is to direct non-emergency crew to a given location.

- iv). Passenger Emergency Intercom
 - (1) A PEI shall be located in every bathroom floor and wall within a sleeper cabin and shall be located in each accessible sleeper cabin as well.
 - (2) The intention of this button is to notify the conductor and flag the entire train that there is an onboard emergency.
 - (3) All communications equipment shall meet the requirements in Chapter 14.
- c). Electrical System
 - i). Electrical equipment information is shared in detail for each room.
 - ii). All electrical equipment in the sleeper cabins shall meet the requirements in Chapter 15.
 - iii). Junction Box
 - (1) The junction box shall be located where practical and shall be presented during the design phase.
 - (2) It shall be easily accessible by the maintenance group.
- d). Lighting System
 - i). Lighting general information is shared in detail for each room. Detailed lighting information can be found in Chapter 13.
 - ii). Note that all lighting part numbers, manufacturers, and temperatures shall be proposed by the Contractor and approved at Amtrak after the lighting simulation during the design review process.
- e). Emergency Equipment
 - i). Chapter 18 details emergency equipment requirements. Generally, the following items shall be included in each room.
 - (1) Smoke Detector
 - (a) Smoke Detectors shall be mounted on the central ceiling panel.
 - (b) The smoke detector used in this location shall be identical to the smoke detectors used in other locations in the trainset for ease of maintenance and replacement.
 - (2) Window Egress
 - (a) Each window on the carshell in a sleeper cabin shall be considered an emergency egress window and shall comply with 49 CFR 238.113.

- f). Security
 - i). Many items within the sleeper cabin area will need to be secured.
 - ii). The following items are identified with specific locking preferences.
 - iii). Any other locking or security items will be discussed with Amtrak during design reviews.
 - (1) Door Locking Mechanism
 - (a) There shall be an automatic door locking system in place for each sleeper cabin.
 - (b) This locking mechanism shall default to locked when the power is on in the car and default to unlocked when no power is provided on the car.
 - (c) Additionally, this locking mechanism shall be unlocked/activated by the keycard and keyless entry feature that is described in Section 11.12.
 - (2) Door Locking Mechanism
 - (a) There shall also be a manual locking system for a passenger to maintain privacy and block inadvertent access into their sleeper cabin.
 - (b) This shall be in the form of a deadbolt type lock or latch.

11.66 Additional Storage in Sleeper Cars

- a). General
 - i). See Chapter 1 for quantity of storage units desired across the trainset and suggested layouts.
 - ii). Storage lockers shall be locked with crew keys or as otherwise approved by Amtrak.
- b). Required Storage Types
 - i). Electrical Cabinets
 - (1) See Chapter 15 for electrical storage requirements.
 - ii). Linen Storage Closets
 - (1) See Section 11.18 for requirements.
 - iii). Consumable Supply Storage
 - (1) See Section 11.19 for requirements.

- iv). Cleaning Supply Storage
 - (1) See Section 11.20 for requirements.
- c). CMF
 - i). General
 - (1) Storage lockers shall match the CMF of the adjacent wall paneling and countertop surfaces.
 - (2) Please refer to the attached CMF document (Exhibit F-2) for exact color, material, and finishes desired in each storage area. Please also refer to Chapter 19.
 - ii). Wall Panels
 - (1) Sidewall Panels along the carshell wall shall be made from molded thermoplastic or melamine resin composite with an easy to clean surface finish.
 - (2) Partition Walls shall be created from a composite structure such as aluminum honeycomb, melamine resin, or HPL skinned honeycomb panels.
 - (3) The finish of the wall and material of the outside skin shall be inspired by the CMF document (Exhibit F-2) and meet all structural requirements for crashworthiness based on mounting and attached loads to the panel.

Part X: Common Use Areas

11.67 Beverage Stations

a). General Requirements

- i). Beverage stations shall be incorporated in storage areas within sleeper cars.
- ii). The beverage station shall utilize the same amenities and appliances in the first-class bar self service area- refer to Chapter 16 for complete requirements and information.
- iii). To the extent possible equipment, parts, and features in the beverage station shall be identical to equipment, parts, and features in the first-class bar self service area.
- iv). The intent of this clause is to minimize spares and maintenance techniques.
- v). Please refer to Chapter 1 for information regarding quantity of this accommodation type desired across the trainset and suggested layouts.
- vi). Beverage stations in cars with accessible sleeper cabins shall be ADA accessible.
- vii). To the extent possible, the Contractor shall adhere to the general arrangement images for the beverage station as shown below.

b). Proposed layout

- i). The layout in Figure 11-121 on page 11-379 shows the proposed approximate locations and relative footprints for each element of the beverage station from an ergonomic and preparation flow perspective.
- ii). The Contractor shall use this layout as the basis for the beverage station design and make adjustments as necessary to provide complete functionality.
- iii). The final layouts will be approved by Amtrak during the design review process.

c). Appliances

- i). The table below lists the desired appliances along with an example part number and the quantity required within the beverage station area.
- ii). Note that example part numbers are given to establish a starting place for appliance performance and will be finalized during the design reviews.
- iii). The car builder will propose the exact manufacturer and part number for each appliance based on functionality, shock and vibration, service history, power requirements, and ability to meet crashworthiness requirements for mounting.

Figure 11-40: Beverage Station Appliances

Appliance	Description	Example Part Number	Quantity Desired
Refrigerated Cabinets	Insulated refrigerator cabinet with ability to keep food goods between 32 and 40 degrees F	-	1
Countertop Workspace	Clear available workspace for food preparation with 6" backsplash and 0.25" radii.	-	As space allows
Coffee Maker	Twin coffee brewer with 1.5 gallon satellite servers,	Wilbur Curtis GEMTS16A-1000	1
Ice Maker	590 lb, 26" wide water cooled, cublet-nugget style ice machine and waster dispenser with bin, countertop mounting, 40lb bin ice storage	Hoshizaki DCM-500BWH	1
Storage	Stainless steel storage space with built in condiment storage compartments	-	1

iv). Detailed functional requirements for each appliance is listed below.

(1) Refrigerated Cabinet

- (a) All features for the refrigerated cabinet shall be identical to the refrigerated cabinet described in the kitchen Chapter 16.
- (b) With the following exception: In this food service area, the cumulative minimum internal volume for the refrigerated cabinets required is 2.875 cu ft. (23 in horizontal x 27 in tall x 8 in deep).
- (c) With the following exception: safety glass clear doors shall be used for this refrigerated cabinet as it may be used as a display or to see the number of beverages stored in the beverage station.
- (d) In addition to the safety glass clear doors, lighting shall be included to illuminate the items inside the display.
- (e) With the following exception: shelving shall be static and spaced 12 inches apart to create space for approximately 30 soda cans.

(2) Countertop Workspace

- (a) All features for the countertop workspace shall be identical to the countertop workspace described in the kitchen Chapter 16.
 - (b) With the following exception: In this food service area, the minimum surface area for workspace required is 1 sq ft.
- (3) Coffee Maker
- (a) A purchased off the shelf item that meets or exceeds the features from the example part number.
 - (b) Example part number listed as Wilbur Curtis GEMTS16A-1000.
 - (c) Twin coffee brewer
 - (d) 1.5 gallon satellite servers,
 - (e) Coffee maker drain shall handle both warmers emptying at the same time with no liquid splashing outside of the drain channel
- (4) Ice Maker
- (a) A purchased off the shelf item that meets or exceeds the features from the example part number.
 - (b) Example part number listed as Hoshizaki DCM-500BWH.
 - (c) 590 lb production capacity in 24 hour period
 - (d) 26" wide
 - (e) water cooled, cublet-nugget style ice machine
 - (f) waster dispenser
 - (g) countertop mounting,
 - (h) 40lb bin ice storage
- (5) Storage Cabinets
- (a) Storage cabinets shall be constructed from stainless-steel.
 - (b) These modules shall be designed to retain goods while the train is in motion.
 - (c) Storage in this location shall be open shelving with retaining bars and include built in condiment storage compartments.
 - (d) This will depend on the item stored in each location and shall be determined with Amtrak during the design reviews.
 - (e) Option for adjustable shelving to accommodate varying products.

- (f) Stainless steel retention bars to prevent items from sliding off the shelf while the train is in motion.
 - (g) Built in condiment storage shall include but not be limited to cups, lids, creamers, stirrers, and sweeteners.
- d). Evaluation Criteria
- i). Sanitary Design
 - (1) Sanitary design shall be evaluated with the following criteria:
 - (a) Appropriate cleaning radii of at least 0.25" on worksurfaces and 0.75" on sink areas.
 - (b) Backsplashes of at least 6" on worksurfaces and sink areas.
 - (c) Appropriate cleaning clearances around appliances such that a 95th percentile male can fit their hand and a rag easily between objects for cleaning.
 - (d) All edges and seams are sealed with silicone sealant and gaps greater than 1/32" are sealed.
 - (e) Floor drains are provided for locations prone to spills and leaks, especially near water piping.
 - (f) Openings are protected from allowing pests and vermin to congregate
 - (g) Proper sealing methods are used to prevent moisture from corroding or otherwise damaging the food service area
 - (h) All drain pans and catches are accessible for cleaning
 - (i) No tools are required to move objects subject to daily cleaning rituals
 - ii). Refrigeration and Freezer Equipment
 - (1) Refrigeration and Freezer Equipment shall be evaluated with the following criteria:
 - (a) Temperature monitoring system functionality
 - (i) Temperature monitoring shall be accomplished through a set of redundant sensors.
 - (ii) The refrigeration controller shall relay temperatures for each of the refrigerated modules locally and in one location on a panel in the kitchen.

- (iii) Additionally, temperatures shall be reported to wayside through the use of a PT100 sensor.
 - 1. The PT100 sensor and the controllers for the equipment shall be calibrated to ensure they are reporting the same temperature.
 - (iv) Temperatures shall be logged and accessible for at least a 6-month period of time after the date of data collection.
 - (v) Temperatures for refrigerated cabinets shall be monitored directly in the refrigeration cabinet at the warmest temperature location and shall inform the setpoint and need for temperature adjustment.
- (b) Yoghurt Test
- (i) Presently, Amtrak monitors the temperature of a refrigerated food cart by placing a yoghurt in the center of the cart and manually records the temperature of the yoghurt on an interval.
 - (ii) If the yoghurt is out of temperature the food in the cart is considered out of temperature and therefore spoiled.
 - (iii) The Contractor shall provide a system that consistently functions without allowing the yoghurt to test out of temperature and cause loss of revenue from spoiled goods.
- (2) Type Tests for refrigeration and freezer systems shall be evaluated using ISO 23953-2 to determine the temperature probe location and validate performance of the system and produce a test report for Amtrak's evaluation and approval as specified in ISO 23953-2:
- (a) The elements of design validation listed in the Section 16.3.d) shall be followed for the refrigerated cabinets in the beverage station and are of particular interest to Amtrak and shall be performed as type tests if information is not included in the ISO 23953-2 test report.

11.68 Lounge

a). General

- i). The lounge shall include all of the elements listed in this Chapter; however, the arrangement of these elements can be modified by the Contractor to best meet the design requirements for the car as a whole.
- ii). If the final layout for the lounge area differs from the suggested layout, the Contractor shall propose the new layout at the PDR with the justification for differences in design and layout.

- iii). The suggested layout for the lounge area shown in Figure 11-122 on page 11-380 shall be used as a reference when designing this area of the car.
- b). Key Features
 - i). A comprehensive list of expected features in the Lounge is provided in Figure 11-41 and described in detail below.
 - (1) Detailed functional requirements for each feature is listed below.
 - (2) In addition to these requirements, the Contractor shall factor in safety, crashworthiness, materials and workmanship, FDA cleaning clearances, radii, and sanitary design.
 - (3) All mechanisms described below should be durable, free from jamming, and racking.
 - (4) The design should meet abuse, load, and crash criteria.
 - (5) Dimensions, position, and usability will be subject to Amtrak approval during the mockup review.

Figure 11-41: Key Features - Lounge

Feature	Short Description	Qty
First Class Bar	Food service Area described in Chapter 16	1
Folded Wheeled mobility device Storage	Open storage location for wheeled mobility devices	1
Accessible Space	Location for someone using a wheeled mobility device to dine and remain using device	1
Accessible Path	32" continuous aisle through portion of the car for ADA regulated aisle	1
60" Turning Circle	60" diameter turning circle for accessibility	3
Skylight Windows	Window mounted on ceiling	Qty to be determined by Contractor, Option to be exercised by Amtrak
Skylight Blinds	Automated blinds for skylight	2 per skylight window
Windows	Includes emergency egress features	Qty to be determined by Contractor
Blinds	Light filtering and black out blind	2 per window
Side Rail	Decorative strip under windows to conceal lighting	As needed
Lower Sidewall Panel	HPL panels and Tedlar style sidewall liners	As needed
Kick Strips	9" stainless steel strips	As needed
Handholds	Meets grab bar requirements in 49 CFR 38.115.	As needed
Window Pillars	Structural member between windows	As needed
HVAC Gondola	HVAC air path through the center of the car	1
Wall Lamps	Light fixtures mounted to window pillars	1 per window pillar
Modular Seat	Square Rounded seat with diamond orientation, two sides exposed and two sides with seatback	26
Power Outlets	Duplex outlets with USB	One per seat
Coffee Table	Central low height table for resting beverages	3
Side Tables	Elbow and beverage rest corners between modular seating	11
Privacy Dividers	Safety glass divider between booths with hand grab features	4
Trash Storage		5

- ii). First Class Bar
 - (1) Please refer to Chapter 16 for information regarding the food service modules and appliances to be placed within the bar.
 - (2) The following features shall be incorporated into the bar:
 - (a) Recessed Handrail
 - (i) A recessed handrail shall be incorporated into the wall for the outside of the coach café.
 - (ii) This handrail shall meet the requirements in 49 CFR 38.115.
 - (b) Toe Rail
 - (i) Footrest around the lower rim of the bar wall shall be aesthetically similar to the handrail and shall not bend, break, or damage the area if a 500 lb point load were given to the surface of the rail.
- iii). Folded Wheeled mobility device Storage
 - (1) A storage space for one folded wheeled mobility device shall be located at the end of the coach café car for passengers wishing to transfer to another seat.
- iv). Accessible Space
 - (1) An accessible space with RVAAC compliant dimensions shall be provided at the accessible table.
 - (2) The accessible space shall also include a fold out seat from the side wall in this location so that if a person using a wheeled mobility device is not occupying the space, another passenger can opt to utilize the area instead.
- v). Accessible Path
 - (1) The lounge car should be fully accessible end to end.
 - (2) There should be a 32" wide accessible path between seating booths and down the side of the café.
 - (3) Where a 90° turn is required across the car, the aisle should be 44" wide.
- vi). 60" Turning Circle
 - (1) There should be a 60" accessible turning space at the end of the lounge.

vii). Skylight Windows

- (1) Options for skylight windows shall be included for all lounge areas.
- (2) Design should incorporate an option to install a luggage shelf and a valance without a luggage shelf, that contains only blinds, hooks, and a seat reservation system.
- (3) Please refer to Section 11.13 for more information regarding window requirements.

viii). Skylight Blinds

- (1) Option for Skylight blinds to be automatic with a crew control switch per car shall be provided.
- (2) Blinds shall be stored in a valance so that they can easily be accessed for maintenance.
- (3) Blinds should cover the entirety of the window.
- (4) Please refer to Section 11.15 for more information regarding window blind requirements.

ix). Window

- (1) Window size should be maximized with an equal pitch where possible.
- (2) All seating positions and accessible spaces should have a view out of the window.
- (3) Please refer to Section 11.13 for more information regarding window requirements.

x). Blinds

- (1) Blinds shall be stored in a valance so that they can easily be accessed for maintenance.
- (2) Blinds should cover the entirety of the window.
- (3) Lower blind handle should be easy to use and accessible with no racking or jamming.
- (4) Please refer to Section 11.15 for more information regarding window requirements.

xi). Side Rails

- (1) Side rails under each window shall include a tideline with integrated lighting to wash lower side wall panel.

xii). Lower Sidewall Panels

- (1) Lower side wall panels shall be provided such that the trim panel has minimized thickness to take advantage of full width of the car body.
 - (2) These should be designed to have well fitted clean panels with a high tolerance build to manage split lines and cabinet edging.
 - (3) There should be no protruding equipment, snag point, or dirt traps.
- xiii). Kick Strips
- (1) Stainless steel kick strips at 9" high should be used in all coach areas.
- xiv). Hand Grab
- (1) Where possible, a compliant accessible grab for passenger navigation shall be available.
 - (2) Grab bar positioning will be subject to mockup testing and Amtrak approval. Grab bar shall meet the requirements in 49 CFR 38.115.
- xv). Window Pillar
- (1) Window pillar width should be minimized.
 - (2) In the case of a car with skylights the pillar trim should continue over the side ceiling to create an arched aesthetic.
- xvi). HVAC Gondola
- (1) Gondola shall be designed to maximize headroom and be suitable to accommodate skylight options.
 - (2) Lighting washes both centrally into gondola and across side ceilings shall be provided.
 - (3) The gondola should terminate and transition to a separate lower ceiling section if any equipment or junction in the interior architecture prevents the gondola from completing a full uninterrupted run. For example - where the ceiling moves around the bar.
 - (4) At these junctions the gondola should terminate in a straight line with architecture that creates a visual ring at the termination point.
 - (5) The transition between ceiling profiles should be treated with clean and well considered intersections.
 - (6) These lower ceilings should have their own lighting light wells and HVAC vents.
- xvii). Wall lamps
- (1) Wall lamps should be provided on every window pillar.

xviii). Modular Seat

- (1) Seat structures of larger modules should be designed so that they can be repeated to house individual seat modules.
- (2) These structures should allow for creation of bays of seats that create a mix of private and convivial settings.
- (3) The furniture system should be simple to maintain and repair, with robust detailing designed for heavy usage.
- (4) The system shall allow seats to be arranged in a variety of seating positions to provide a full range of viewing experiences.
- (5) All individual seat modules should have the same dimensions but can be orientated differently either by rotating them through 90 or 180 degrees.
- (6) Creating a mirrored instance is also acceptable.
- (7) Twin seats should be arranged to form couches for two in combination with single seats for one.
- (8) Seating orientations should be created so that passengers can be seated in positions that look out both sides on the train.
- (9) Lounge seats should have a minimum seat pan depth of 20" and a minimum seat width of 20". Seat pan height should be a minimum of 18".

xix). Outlets

- (1) Duplex outlets with two USB sockets shall be provided for each seated passenger.
- (2) The outlets shall be located in easy reach of people while seated.

xx). Coffee Table

- (1) Coffee tables should be provided within lounge booths.
- (2) Coffee tables should have marine edge milled into the solid surface material.
- (3) Crew only access to trunk storage should be provided for additional and emergency storage.

xxi). Side Tables

- (1) Lounge modules should provide integrated side tables - side tables should have marine edges built into the top surface or created using a trim edge.

xxii). Privacy Dividers

- (1) Privacy dividers should be included where seating is back-to-back or where passengers' heads are in close proximity.
- (2) The height of the divider will need to be managed carefully as to be low enough not to obstruct view out of the windows, yet high enough to provide some level of privacy for seated passengers.
- (3) Dividers should include different levels of transparency and material selections to break up volumes and to allow spread of light.
- (4) Divider edges are protected by a trim detail which should be strong enough to acts as a proxy handhold.
- (5) Purposeful and compliant handhold integrated with the divider should be located on entry and exit points to lounge booths.
- (6) Divider heights should range between 42" and 47".
- (7) Divider heights should vary to provide depth and layering to the interior aesthetic.

xxiii). Trash Bin

- (1) Trash bins shall be provided with stainless steel push flaps.
- (2) Please refer to section 11.17 for more information on trash and recycling requirements.

c). CMF

- i). Please refer to the attached CMF document (Exhibit F-2) for exact color, material, and finishes desired in this lounge area.
- ii). Please also refer to Chapter 19.
- iii). Wall Panels
 - (1) Sidewall Panels along the carshell wall shall be made from molded thermoplastic with an easy to clean surface finish.
 - (2) Partition Walls shall be created from a composite structure such as aluminum honeycomb or HPL skinned honeycomb panels.
 - (3) The finish of the wall and material of the outside skin shall be inspired by the CMF document (Exhibit F-2) and meet all structural requirements for crashworthiness based on mounting and attached loads to the panel.
- iv). Ceiling

- (1) Ceiling shall be created from a composite structure such as aluminum honeycomb or HPL skinned honeycomb panels.
 - (2) The finish of the passenger facing side of the ceiling panel and material of the outside skin shall be inspired by the CMF document (Exhibit F-2) and meet all structural requirements for crashworthiness based on mounting and attached loads to the panel.
 - (3) The finish of the material on the non-passenger facing side shall be coated such that there is no risk of corrosion from moisture from steam or humidity within the car.
- v). Flooring
- (1) Flooring within the lounge area shall be carpet flooring as listed in section 11.35.
 - (2) Flooring shall be durable to withstand spills, leaks, and all methods of cleaning. Flooring shall also not become frequently damaged or worn.
 - (3) Flooring shall have enough give to prevent fatigue from standing.
- vi). Lighting
- (1) General
 - (a) Lighting general information is shared in detail for each room.
 - (b) Detailed lighting information can be found in Section 13, Lighting System.
 - (c) Note that all lighting part numbers, manufacturers, and temperatures shall be proposed by the Contractor and approved at Amtrak after the lighting simulation during the design review process.
 - (d) Ceiling lighting shall match the ceiling lighting in the coach cars.
 - (2) Wash Lights (RGB Lights)
 - (a) Dado Lighting Wash
 - (i) Indirect wash lighting that shines down the entire length of the side wall under the windows.
 - (3) Compartment Lighting (RGB Lights)
 - (a) Under Table and Seat Lighting
 - (i) Wash lighting under the table or under the seats shall provide indirect light.
 - (b) Divider Wash Lighting

- (i) Upward wash lighting should be provided on dividers.
 - (ii) This should be recessed into a pocket to wash light onto the divider while the direct light source hidden from passenger view.
- (c) Wall Lamp
 - (i) On each window pillar a wall lamp shall be provided that casts indirect light onto the pillar.
 - (ii) The lamp is intended to be a premium design feature that contributes to the overall lighting levels of the space.
 - (iii) Lamp design, spread of light, lamp shade material and detail design will be subject to Amtrak's approval.
- (4) Bar Area Lighting (RGB Lights)
 - (a) LED Strip Accent Light
 - (i) Feature strip light celebrates architecture of space highlighting the shape of the bar.
 - (b) LED Panel Spot Lights
 - (i) LED panel spots light the inside of the bar area. Placement number and position subject to Amtrak approval.
 - (c) Kick Strip and Toe Kick Wash
 - (i) Indirect mood lighting that washes down the kick plates.
 - (d) Counter Wash
 - (i) Indirect wash light from the counter edge down into the entire edge of the servery counter.
 - (e) Back Wall Panel Wash
 - (i) Back bar wall illuminated to provide standout of liquor and glass ware.
 - (f) Brand Light
 - (i) Amtrak 3D Logo backlighting
 - (g) Bar Counter Back Light
 - (i) Back of house light under counter top
 - (h) Pendant Feature Lights

- (i) Pendent feature lights create ambient lighting that mirror the server station bench.

11.69 Diner

a). General

- i). The diner shall include all of the elements listed in this section; however, the arrangement of these elements can be modified by the Contractor to best meet the design requirements for the car as a whole.
- ii). If the final layout for the diner area differs from the suggested layout, the Contractor shall propose the new layout at the PDR with the justification for differences in design and layout.
- iii). The suggested layout for the diner area shown in Figure 11-123 on page 11-381 shall be used as a reference when designing this area of the car.

b). Key Features

- i). A comprehensive list of expected features in the diner is provided in Figure 11-42 and described in detail below.

Figure 11-42: Key Features - Diner

Feature	Short Description	Qty
Table Module	Repeatable dining table for 4 passengers	13
Servery	Food service Area described in Chapter 16	1
Booth Seating	Repeatable and modular bench seating for 2 passengers each	28
Accessible Table	Modified version of table module with flip up portion	2
Folded Wheeled mobility device Storage	Open storage location for wheeled mobility devices	2
Accessible Space	Location for someone using a wheeled mobility device to dine and remain using device	2
Accessible Path	32" continuous aisle through portion of the car for ADA regulated aisle	1
60" Turning Circle	60" diameter turning circle for accessibility	1
Service Station	Convenience station for LSA in the diner	1
Skylight Windows	Window mounted on ceiling	Qty determined by Contractor if option exercised by Amtrak.
Skylight Blinds	Automated blinds for skylight	2 per skylight window
Windows	Includes emergency egress features	Qty determined by Contractor
Blinds	Light filtering and black out blind	2 per window
Wall Lamps	Light fixtures mounted to window pillars	1 between each booth
Table Lamps	Light fixtures mounted to tables	1 per table
Privacy Divider	Safety glass divider between booths with hand grab features	1 between each booth

- (1) Detailed functional requirements for each feature is listed below.
- ii). Table Module
 - (1) A repeatable 'workstation' table module shall be used in the diner.
 - (2) A high-quality table surface should be used and shall have a protective edge trim detail.
 - (3) Split lines should be managed to a high tolerance and sealed to create a flush finish and prevent any potential dirt build up in edges.
 - (4) A minimum usable table length of 32" shall be provided.
 - (5) Access in and out of the seat should be evaluated carefully. A tapered leading edge may be required to aid access to the seat.
 - (6) Top of table surface should be between 27" and 28" while also allowing 3" clearances in height for the legs for a 95th percentile male.
 - (7) Table leg location shall be positioned as to not provide a knee clash for passengers.
 - (8) All table dimensions will be subject to mock-up review, testing and approval by Amtrak.
 - (9) A fixed workstation table shall be provided compliant with APTA Standard PR-CS-S-018-13.
 - (10) Energy absorption features shall be built into the workstation table and/or its attachments such that human injury criteria for the 50th percentile HIII male ATDs are not exceeded during dynamic sled testing, per the requirements specified in APTA Standard PR-CS-S-018-13, Section 5.2.1, modified for testing with a workstation table installed.
 - (11) The table must meet the performance requirements specified in Section 5.2.1.3 of APTA Standard SS-C&S 016-99.
 - (12) The table must not become detached from its mountings and the ATDs must remain compartmentalized between the table and the launch seat.
 - (13) Workstation tables shall be attached to the carbody via the wall seat track and to the floor seat track.
 - iii). Servery
 - (1) Please refer to Chapter 16 for information regarding the food service modules and appliances to be placed within the servery.

- (2) The following features shall be incorporated into the Servery:
 - (a) Digital Menus
 - (i) Qty 2 shall be provided.
 - (ii) Please refer to digital displays Section 11.25 for more information on these requirements.
 - (iii) One menu display shall be located near the point of sale.
 - (iv) One menu display shall be located along the aisle side of the servery.
 - (b) Recessed Handrail
 - (i) A recessed handrail shall be incorporated into the side wall of the carshell along the servery in the diner.
 - (ii) This handrail shall meet the requirements in 49 CFR 38.115.
- iv). Booth Seating
 - (1) Arrangement and Dimensions
 - (a) A repeatable booth module of back-to-back seating shall be provided in the diner.
 - (b) Booths should be 2x2 across the aisle.
 - (c) Seats shall be mounted to the seat tracks in accordance with the strength and crashworthiness requirements of 49 CFR Section 238.233 (a) and APTA standard PR-CS-S-016-99 as applicable.
 - (d) Seat width shall be maximized with a minimum acceptable dimension of 40" wide for a seat suitable for two passengers.
 - (e) To achieve a 32" accessible path between diner seats the side wall detail/clearance will need to be minimized and tolerances will need to be tightly controlled.
 - (f) Seat pan height shall be between 18" and 19" with a seat pan depth of no less than 18".
 - (g) Seat back height from finished floor should be a minimum of 38" with a higher divider no lower than 44".
 - (h) All seat dimensions, cushion density/ shore hardness will be subject to mock-up review, testing and approval by Amtrak.
 - (i) Booths shall be located on either side of a table in the diner.

- (j) The table shall be centered in the window alignment.
- (k) The privacy dividers in each booth shall align with the window pillars in a repeating 81" pitch.
- (2) Under-Seat Storage
 - (a) Each booth seat shall be designed such that under the seat cushion there is a storage compartment for crew and diner emergency storage items.
 - (b) The access to these seats should not impact the seat comfort or aesthetic.
 - (c) The actions required to access to the storage location should take the average person under 1 min.
- (3) Seat Cushions
 - (a) Booth seat cushions should be contoured to aid seat comfort.
 - (b) Seat cushions shall provide ergonomic support in the following locations: back support, seat back and seat pan pillowing.
 - (c) Cushioning, seat trim, and detailing will be evaluated during the design review process.
- (4) Pedestals
 - (a) Booth seats shall be mounted on a pedestal that is seamless with the floor, with no dirt traps, or protruding edges.
 - (b) Pedestals shall be undercut from the seat base to provide a floating seat aesthetic.
- (5) Materials
 - (a) The seat structure should be finished with high-quality, hard-wearing laminates and veneers.
 - (b) Laminate edges shall be protected with delicate trim details.
- (6) Amtrak Approval
 - (a) Booth seating details shall be presented for Amtrak approval during the PDR.
 - (b) Final seat configuration and comfort shall be subject to Amtrak approval based on documentation and mockup information presented by the Contractor.
- v). Accessible Table

- (1) The booth table at the accessible space location shall differ from the standard booth table but shall meet the same strength requirements.
 - (2) In order to utilize the space to its full extent, fold down seats may be incorporated.
 - (3) In this instance, the accessible space shall also include a fold out seat from the side wall in this location so that if a person using a wheeled mobility device is not occupying the space, another passenger can opt to utilize the area instead.
- vi). Folded Wheeled mobility device Storage
- (1) A storage space for two folded wheeled mobility devices shall be located at the end of the diner car for passengers wishing to transfer to another seat.
- vii). Accessible Space
- (1) An accessible space with RVAAC compliant dimensions shall be provided at the accessible table.
 - (2) The accessible space shall also include a fold out seat from the side wall in this location so that if a person using a wheeled mobility device is not occupying the space, another passenger can opt to utilize the area instead.
- viii). Accessible Path
- (1) The diner car should be fully accessible end to end. There should be a 32" wide accessible path between seating booths and down the side of the servery. Where a 90° turn is required across the car, the aisle should be 44" wide.
- ix). 60" Turning Circle
- (1) There should be a 60" accessible turning space at the middle point of the diner.
- x). Service Station
- (1) A service station should be provided within the Diner.
 - (2) The purpose of this station is to assist crew with performing an efficient food service.
 - (3) Crew will use the station to replenish the tables so should be designed to store provisions needed for table settings including cutlery, napkins (standard and small beverage) menus and items to support coffee service.
 - (4) It should have open storage and closed storage and may also require a trash bin.

- (5) The detailed design and service strategy will be defined further during PDR.
- (6) The exact design, use, and purpose of the cubbies in the service station shall be developed with Amtrak during the PDR.
- (7) A single large opening in the solid surface countertop where smaller bins, trays, or tubs can be stored shall function as the starting place.

xi). Skylight Windows

- (1) Skylight windows shall be included in the offering from the Contractor for Amtrak to exercise as an option.
- (2) Skylight windows shall line up with the coach sidewall windows on the upper level of the car and will be of the same width along the car.
- (3) Skylight windows shall be mounted at an angle on the roof of the car.
- (4) The depth that the window extends inward along the roof of the car shall be determined by the Contractor but shall be no less than 26" x 24" so that the skylight window can serve a dual purpose of providing emergency roof access according to 49 CFR 238.123 as a rescue access window according to 49 CFR 238.114.

xii). Skylight Blinds

- (1) Two types of pull-down blinds shall be provided.
- (2) Each blind should work individually or in combination, so they provide two layers of shade.
- (3) An outside sunshade shall provide daytime protection and a second inside black out blind shall cut out all light and provides complete privacy.
- (4) These blinds shall be automated so that the conductor can deploy or retract the blinds at the push of a button.

xiii). Windows

- (1) Each window shall be an emergency exit window and rescue access window. Windows shall comply with 49 CFR 238.113 and 238.114.

xiv). Blinds

- (1) Two types of pull-down blinds shall be provided.
- (2) Each blind should work individually or in combination, so they provide two layers of shade.

- (3) An outside sunshade shall provide daytime protection and a second inside black out blind shall cut out all light and provides complete privacy.
 - (4) The blinds in this location shall be operated manually by a passenger.
 - xv). Wall lamps
 - (1) Wall lamps should be provided on every window pillar.
 - xvi). Table lamps
 - (1) A table lamp shall be provided at every table against the side wall.
 - (2) An integrated condiment basket or rail shall be provided on the base of the lamp suitable to store a varied arrangement of condiments to be defined during PDR.
 - xvii). Privacy dividers
 - (1) A glazed privacy divider shall be provided between back-to-back booth seats. The divider frame shall be integrated with handholds.
 - (2) Handholds complying with 49 CFR 38.115 shall be provided as part of the privacy divider on the aisle side of every booth seat.
- c). Diner Interior Structures
 - i). Side Rails
 - (1) Side rails shall be included under the windows along the side walls. The side rails shall include a tideline features with integrated lighting to wash lower side wall panel.
 - ii). Lighting and HVAC Gondola
 - (1) The lighting and HVAC gondola features should match the coach interior structure specification from Section 11.38.
 - (2) Ceiling profiles should transition to an alternate section to accommodate the Servery architecture.
 - (3) It is acceptable that skylight windows also transition to a standard window arrangement along the aisle of the Servery.
 - (4) Ceiling profiles should transition to an alternate section to accommodate electrical cupboard, plenum chambers or crew cupboards.
 - (5) It is acceptable that skylight and windows also terminate at these junctions.
 - iii). Window Pillars

- (1) Window pillar width should be minimized. The pillar trim should continue over the side ceiling to create an arched aesthetic.
- iv). Kick Strips
 - (1) 9" tall stainless steel kick strips shall be mounted along the length of the diner.
- v). Side Wall Panels
 - (1) Side wall panels shall include trim panels as categorized in Section 11.33 with minimized thickness to take advantage of full width of the car body.
- vi). OPTION- Crew Utility Office
 - (1) Crew Utility office designed as a dedicated crew work space, centrally located within the upper level of the diner shall be provided as an option.
 - (2) In the same footprint as a single diner table/booth module, the office should provide a tabletop workstation and seating for one to two crew members to support crew responsibilities during and/or between meal service.
 - (3) The office will serve as a staging area for table clothes, linens, cutlery roll-ups, table ware or similar.
 - (4) The office should be enclosed with full height walls and a pocket door.
 - (5) The office should maximize available space for additional storage via shelving and/or cabinet space. Spatial allowance for storage of up to two additional service carts is preferred.
- d). CMF
 - i). Please refer to the attached CMF document (Exhibit F-2) for exact color, material, and finishes desired in this coach café area. Please also refer to Chapter 19.
 - ii). Wall Panels
 - (1) Sidewall Panels along the carshell wall shall be made from molded thermoplastic with an easy to clean surface finish.
 - (2) Partition Walls shall be created from a composite structure such as aluminum honeycomb or HPL skinned honeycomb panels.
 - (3) The finish of the wall and material of the outside skin shall be inspired by the CMF document (Exhibit F-2) and meet all structural requirements for crashworthiness based on mounting and attached loads to the panel.

iii). Ceiling

- (1) Ceiling shall be created from a composite structure such as aluminum honeycomb or HPL skinned honeycomb panels.
- (2) The finish of the passenger facing side of the ceiling panel and material of the outside skin shall be inspired by the CMF document (Exhibit F-2) and meet all structural requirements for crashworthiness based on mounting and attached loads to the panel.
- (3) The finish of the material on the non-passenger facing side shall be coated such that there is no risk of corrosion from moisture from steam or humidity within the car.

iv). Flooring

- (1) Flooring within the diner area shall be anti-slip flooring under the tables and high traffic carpet along the aisle as listed in Section 11.35.
- (2) Flooring shall be durable to withstand spills, leaks, and all methods of cleaning. Flooring shall also not become frequently damaged or worn.
- (3) Flooring shall have enough give to prevent fatigue from standing.

v). Lighting

(1) General

- (a) Lighting general information is shared in detail for each room.
- (b) Detailed lighting information can be found in Chapter 13.
- (c) Note that all lighting part numbers, manufacturers, and temperatures shall be proposed by the Contractor and approved at Amtrak after the lighting simulation during the design review process.

(2) Ceiling Lighting

- (a) Ceiling lighting shall match the ceiling lighting in the coach cars.

(3) Wash Lights (RGB Lights)

- (a) Dado Lighting Wash – indirect wash lighting that shines down the entire length of the side wall under the windows.

(4) Compartment Lighting (RGB Lights)

(i) Under Table Lighting

1. Wash lighting under the table or under the seats shall provide indirect light.

- (ii) Table Booth Lamp
 - 1. At each table position a table lamp shall be provided.
 - 2. The lamp is intended to be a premium design feature that contributes to the overall lighting levels of the space.
 - 3. Lamp design, spread of light, lamp shade material and detail design will be subject to Amtrak's approval.
- (iii) Wall Lamp
 - 1. On each window pillar a wall lamp shall be provided that casts indirect light onto the pillar.
 - 2. The lamp is intended to be a premium design feature that contributes to the overall lighting levels of the space.
 - 3. Lamp design, spread of light, lamp shade material and detail design will be subject to Amtrak's approval.
- (5) Servery Area Lighting (RGB Lights)
 - (a) Kick Strip Wash
 - (i) Indirect mood lighting that washes down the kick plates.
 - (b) Counter Wash
 - (i) Indirect wash light from the counter edge down into the entire edge of the servery counter.
 - (c) Vertical Wash
 - (i) Indirect wash lights that frame entry monuments
 - (d) Brand Light
 - (i) Amtrak 3D Logo backlighting
 - (e) Pendant Feature Lights
 - (i) pendent feature lights create ambient lighting that mirror the server station bench.

11.70 Café

a). General

- i). The coach café shall include all of the elements listed in this section; however, the arrangement of these elements can be modified by the Contractor to best meet the design requirements for the car as a whole.

- ii). If the final layout for the coach café area differs from the suggested layout, the Contractor shall propose the new layout at the PDR with the justification for differences in design and layout.
 - iii). The suggested layout for the coach café area shown in Figure 11-124 on page 11-382 shall be used as a reference when designing this area of the car.
- b). Key Features
- i). A comprehensive list of expected features in the café is provided in 11-276 and described in detail below.
 - ii). Table Shelves
 - (1) Small shelves on bulkhead/partition walls suitable to provide a place to rest a drink or snack.
 - (2) Space for trash should be maximized below.
 - (3) The table shelves shall be at least 8" deep.
 - (4) The trash and recycling bins below should provide the trash volume required for this area and listed in Section 11.17.
 - (5) The top table of the table shelves shall be made from solid surface material and shall include a marine edge.
 - iii). Side Loading Doors
 - (1) Side access doors on the second level shall be included for loading and unloading the food service items from the café.
 - (2) The doors are described in Chapter 12.

Figure 11-43: Key Features - Café

Feature	Short Description	Qty
Table Shelves	Trash modules with marine edge solid surface countertop	2
Side Loading Doors	Access doors for loading and unloading food service goods	2
Coach Café	Food service area described in Chapter 16	1
Booth Seating	Repeatable and modular bench seating for 2 passengers each	7
Accessible Table	Modified version of table module with flip up portion	1
Folded Wheeled mobility device Storage	Open storage location for wheeled mobility devices	1
Accessible Space	Location for someone using a wheeled mobility device to dine and remain using device	1
Accessible Path	32" continuous aisle through portion of the car for ADA regulated aisle	1
60" Turning Circle	60" diameter turning circle for accessibility	1
Kick Plates	9" stainless-steel replaceable plates	As needed

- iv). Coach Café
 - (1) Please refer to Section 16.4. for information regarding the food service modules and appliances to be placed within the coach café.
 - (2) The following features shall be incorporated into the coach café:
 - (a) Digital Menus
 - (i) Qty 3 shall be provided.
 - (ii) Please refer to Section 11.25 for more information on these requirements.
 - (iii) One menu display shall be located near the point of sale and the dry display.
 - (iv) One menu display shall be located along the aisle side of the coach café.
 - (v) One menu display shall be located perpendicular to the aisle on the wall where the service counter ends.
 - (b) Recessed Handrail
 - (i) A recessed handrail shall be incorporated into the wall for the outside of the coach café. This handrail shall meet the requirements in 49 CFR 38.115.
- v). Booth Seating
 - (1) Booth and table seating modules should be provided to the same design and specification as the Diner booth seats
 - (2) Seats shall be mounted to the seat tracks in accordance with the strength and crashworthiness requirements of 49 CFR Section 238.233 (a) and APTA standard PR-CS-S-016-99.
 - (3) A simplified CMF palette may also be required for booth seating in this location
 - (4) Booth seating details shall be presented for Amtrak approval during the PDR.
- vi). Accessible Table
 - (1) The booth table at the accessible space location shall differ from the standard booth table.
 - (2) The accessible table should have a fold up leaf to allow for large mobility devices and aid in wheeled mobility device maneuverability when a passenger is dining in this location.

- vii). Folded Wheeled mobility device Storage
 - (1) A storage space for one folded wheeled mobility device shall be located at the end of the coach café car for passengers wishing to transfer to another seat.
- viii). Accessible Space
 - (1) An accessible space with RVAAC compliant dimensions shall be provided at the accessible table.
 - (2) In order to utilize the space to its full extent, fold down seats may be incorporated.
 - (3) In this instance, the accessible space shall also include a fold out seat from the side wall in this location so that if a person using a wheeled mobility device is not occupying the space, another passenger can opt to utilize the area instead.
- ix). Accessible Path
 - (1) The cafe car should be fully accessible end to end. There should be a 32" wide accessible path between seating booths and down the side of the cafe.
 - (2) Where a 90° turn is required across the car, the aisle should be 44" wide.
- x). 60" Turning Circle
 - (1) There should be a 60" accessible turning space at the end of the cafe.
- xi). Kick plates
 - (1) 9" stainless steel kickplates shall be used in the coach café car.
- xii). Optional Enhancements
 - (1) The following enhancements to the façade of the coach café shall be provided as options for Amtrak to exercise:
 - (a) Cart Access Hatch
 - (i) An access hatch shall be incorporated in the short side of the curved wall of the coach café for refrigerated carts to pass through.
 - (ii) This is intended to ease loading of carts from the side loading door into the refrigerated docking stations in the coach café.
 - (iii) This hatch requires a break in the wall and solid surface with a hinged and locking partition door.

- (iv) This shall not prevent any item listed in Section 16.4. from being provided within the Café.
 - (v) The hatch shall not create any pinch points or locations for debris, dirt, or bacteria accumulation according to the FDA guidelines.
 - (b) Pass Through Customer Trash
 - (i) Trash flaps shall be provided along the aisle side of the trash container in the coach café so that passengers walking down the aisle can use the galley trash bins.
 - (ii) These trash flaps shall not restrict the trash storage requirements for the Café in Chapter 16.
 - (iii) They shall be easily cleanable and not provide any pinch point hazards.
- c). CMF
 - i). Please refer to the attached CMF document (Exhibit F-2) for exact color, material, and finishes desired in this coach café area. Please also refer to Chapter 19.
 - ii). Wall Panels
 - (1) Sidewall Panels along the carshell wall shall be made from molded thermoplastic with an easy to clean surface finish.
 - (2) Partition Walls shall be created from a composite structure such as aluminum honeycomb or HPL skinned honeycomb panels.
 - (3) The finish of the wall and material of the outside skin shall be inspired by the CMF document (Exhibit F-2) and meet all structural requirements for crashworthiness based on mounting and attached loads to the panel.
 - iii). Ceiling
 - (1) Ceiling shall be created from a composite structure such as aluminum honeycomb or HPL skinned honeycomb panels.
 - (2) The finish of the passenger facing side of the ceiling panel and material of the outside skin shall be inspired by the CMF document (Exhibit F-2) and meet all structural requirements for crashworthiness based on mounting and attached loads to the panel.
 - (3) The finish of the material on the non-passenger facing side shall be coated such that there is no risk of corrosion from moisture from steam or humidity within the car.

iv). Flooring

- (1) Flooring within the coach café area shall be anti-slip flooring as listed in section 11.35.
- (2) Flooring shall be durable to withstand spills, leaks, and all methods of cleaning. Flooring shall also not become frequently damaged or worn.
- (3) Flooring shall have enough give to prevent fatigue from standing.

v). Lighting

- (1) Lighting general information is shared in detail for each room.
- (2) Detailed lighting information can be found in Chapter 13.
- (3) Note that all lighting part numbers, manufacturers, and temperatures shall be proposed by the Contractor and approved at Amtrak after the lighting simulation during the design review process.

(4) Wash Lights

(a) Contour Wash Lightning

- (i) Indirect wash lighting that shines down from under the counter onto the wall outlining the entire front edge of the service counter and side wall.

(b) Kick Strip Wash Lighting

- (i) Indirect wash lighting that shines down the entire length of the kick strips along the cafe

(5) Featured Lighting

(a) Coach Café Framing Light

- (i) A feature strip light that celebrates architecture of space highlighting the wide-open counter and service area.

(b) Brand Light

- (i) Backlighting for the Amtrak 3D logo on the aisle side wall of the coach café.

(c) Moon Pool

- (i) Moon pool feature light central to the waiting area of the coach café that indirectly illuminates the central light well.

(a) Display Lighting

- (i) Strip lighting

1. Illuminate all display areas with indirect lighting.

(b) LED Spotlights

- (i) Spotlights cast down light on top of the service counter.
- (ii) Frames shall be color matched with the ceiling panel above the service counter.

11.71 Lactation Room (Option)

- a). A lactation room is defined as a hygienic place that is:
 - i). not part of a bathroom,
 - ii). shielded from view,
 - iii). free from intrusion,
 - iv). accessible to disabled individuals including wheeled mobility device users,
 - v). contains a chair and a working surface
 - vi). Is easy to locate
 - vii). Is clearly defined with signage
 - viii). Contains an electrical outlet
 - ix). Available to employees and passengers for expressing breast milk
- b). A lactation room shall be provided in each trainset in the same car as the Café. This room shall have the following features:
 - i). Lactation Compartment Door
 - (1) The door to the compartment shall be the same manually operated, sliding door as is used for a standard sleeper compartment. (see Section 11.58a) on page 11-201)
 - (2) The door latch, with a handle on both sides of the door, shall engage automatically when the door moves towards a closed position, but the lock requires definite action to engage.
 - (3) The door shall remain in the fully closed position at any permissible train speed.
 - (4) The lock shall be operable, in an emergency, from the outside with a standard Amtrak coach key.
 - (5) An instruction, in accordance with Amtrak Specification # 697, located on the interior side of the door, shall provide lock operating instructions.

- ii). Outlets
 - (1) Three duplex outlets with three USB sockets shall be provided in the lactation room.
 - (2) The outlets shall be located above the armrest height and in easy reach of passengers while seated.
- iii). Attendant Call Button
 - (1) A backlit button that pages the attendant assigned to this sleeper cabin. Please refer to Chapter 14 for complete information on this call button.
- iv). Premium Sleeper Cabin Seat
 - (1) The Contractor shall install a Premium Sleeper Cabin Seat, as described in Section 11.60b) on page 11-214.
 - (2) This includes cushions, headrests, armrests and side pads.
 - (3) The seat should rotate to aid ingress and egress and should rotate 180° to allow passengers to comfortably use the desk/table.
- v). Cup Holder
 - (1) A cup holder shall be provided as described in Section 11.60l) on page 11-218.
- vi). Bottle Holder
 - (1) A small cubby should be built into the side wall by the window.
 - (2) The bottle holding cubby should be suitable to house a 17-ounce water bottle with a diameter of 3".
 - (3) Bottle holders should have an open bottom or a clip out part so the bottom of the pockets can be easily cleaned if filled with trash.
 - (4) Dimensions, position, and usability is subject to Amtrak approval during the mockup review.
- vii). Seating Area Vanity
 - (1) Directly behind the second seat shall be a vanity that includes a mirror, a desk, and shelf.
 - (2) Vanity Mirror
 - (a) A mirror constructed from safety glass shall be located above the desk portion of the vanity.

- (b) A 20" diameter, large, circular mirror should be supplied with integrated lighting.
 - (c) The bottom edge of the reflective surface should be a maximum of 40" above the finish floor.
 - (d) Dimensions, position, and usability will be subject to Amtrak approval during the mockup review.
 - (3) Vanity Desk
 - (a) The desk shall include a slide out drawer mechanism to expand the workspace.
 - (b) The desk when extended shall provide a minimum workspace of 24" x 14".
 - (4) Vanity Shelf
 - (a) A fold out storage shelf with a retention bar shall be supplied in the vanity area.
 - (b) This should be separate from the main desk.
 - (c) When deployed, the shelf should be a minimum of 6" deep.
 - (d) A portion of the shelf should be able to store containers or bottles with a minimum dimension of 3" x 10".
- viii). Baby Cradle
 - (1) Cradle shall have 4 sides so that a baby can be retained within the cradle in a hands-free manner.
- ix). Facial Tissue Dispenser
 - (1) A facial tissue dispenser with a finished front plate shall be integrated into the vanity space.
- x). Hand Sanitizer Dispenser
 - (1) A base for a liquid hand sanitizer dispenser shall be installed adjacent to the mirror.
 - (2) The base shall one that will accept a Celeste Industries liquid hand sanitizer refill.
- xi). Small Luggage Storage Space
 - (1) Small luggage storage space shall be provided to keep baggage out of the way of egress and moving within the lactation room.

- xii). CMF
 - (1) Please refer to the attached CMF document (Exhibit F-2) for exact color, material, and finishes desired in this restroom area. Please also refer to Chapter 19.
- xiii). Lighting
 - (1) LED Panel Spot Lights (White Lights)
 - (a) Two small circular LED light panels shall act as spot lights above the entry door.
 - (b) The frame for the spot lights shall be color matched to the ceiling.
 - (2) Wash Lights in the Lactation Room- RGB Lights
 - (a) Wall wash lights for both carshell walls shall be provided along the length of each wall above the windows and shall illuminate the sidewall and blinds.
 - (3) Compartment Light in the Lactation Room- RGB Lights
 - (a) Upper Vanity shall be lit with indirect lighting and shall allow the entire vanity alcove to be illuminated.
 - (b) Lower Vanity shall be lit with indirect lighting and shall allow the entire vanity alcove to be illuminated.

11.72 Drinking Water Stations

- a). The Food Service car shall have a drinking water station in each trainset located in the cafe car. The drinking water station shall have the following features:
 - i). Recessed water dispenser with drain in accordance with the requirements listed in Chapter 17.
 - ii). An access side panel secured with quarter-turn fasteners for access to the water valves for maintenance
 - iii). ADA compliant design
 - iv). Shall operate with IR sensor
- b). The dispenser shall be arranged to permit passengers to easily refill a 1-quart water container.
- c). The design shall be in compliance with 21 CFR Part 1250 and US Public Health Service (USPHS) requirements, arranged for ease of sanitation, and approved by Amtrak.
- d). Alternative designs can be provided for review and approval by Amtrak.

- e). An option for a drinking water station shall be provided in each coach car for Amtrak to exercise during the design reviews.

Part XI: Utility Cars

11.73 Utility Car - Baggage Area

- a). General
 - i). Baggage cars will be used in Amtrak's long-distance passenger trains and will be loaded with a mix of baggage types, such as checked baggage, carry-on baggage, regular pallets, express pallets, bicycles, etc.
 - ii). The baggage volume shall be guided by the information presented in Chapter 1 as well as the compliance with the baggage analysis required in Section 11.22.
 - iii). Configuration of the interior shall provide flexibility to handle different baggage types with relative ease and not require tools to reconfigure.
 - iv). Functionality of various equipment within the car shall be intuitive and obvious. Design and assembly of the interior shall be clean and integrated with easy access for routine maintenance.
 - v). The car's interior shall be designed for safety, functionality, reliability, durability and require minimal maintenance.
- b). Location
 - i). A separate area shall be provided in the lower level of the utility car for storing checked baggage and passenger-loaded bicycles.
- c). Configuration
 - i). The Baggage car shall incorporate 18 luggage towers that run along the car sidewalls, 9 on each side of the central aisle running the length of the car.
 - ii). In each luggage tower, three robust tubular racks fold outward from the wall (similar to Surfliner) to accommodate luggage of varying sizes, or if retracted, to expose bicycle racks.
 - iii). All folding devices shall be secured by passive latches, which cannot be accidentally deployed.
 - iv). Dividers are included between the rack sections to compartmentalize cargo, so it does not shift.
 - v). The car interior shall be divided into three areas:
 - (1) A-End and B-End Sections
 - (a) The two end sections are divided from the loading door areas by bulkheads and are intended for smaller, more portable items, such as luggage and bicycles.

- (b) The cars shall be designed to tolerate extreme loading conditions, forklifts, pallet jacks, wear, exposure to severe weather conditions, salt, water, acidic fluids, etc.
- (2) Central Section
 - (a) The central section, comprising the area between the side loading doors, has an unrestricted floor area when the luggage racks are retracted, allowing the easy placement of large cargo items, such as pallets.
- d). CMF
 - i). Car interior walls, end sheets and ceiling shall be painted gloss white to improve visibility in the room.
 - ii). Interior ends and side walls as well as the ceiling of the Baggage car shall be austenitic stainless steel painted gloss white with a durable paint to enhance artificial and natural lighting within the car.
- e). Durability
 - i). The area around the side loading doors will be subject to considerable abuse from impact with luggage and forklifts during the loading and unloading process.
 - ii). Accordingly, the areas immediately surrounding them shall be constructed robustly and of tough materials which can tolerate these impacts for the life of the car without sustaining serious blemishes.
 - iii). Likewise, the side loading doors are heavy, and the associated stops and hold-open latches shall be designed to withstand this type of service for the life of the car.
 - iv). The approach to be taken to achieve these requirements shall be part of the design review process.
- f). Lighting
 - i). Lighting for the side loading doors areas shall be fluorescent type fixtures, designed and located to illuminate not only the area inside the car, but also to shine outward onto the station/ shop platform to facilitate the loading/unloading process during the trip.

11.74 Utility Car - Luggage Racks

- a). Quantity and location of luggage racks shall be guided by the information presented in Chapter 1 as well as the compliance with the baggage analysis required in Section 11.22.
- b). A luggage rack/tower shall be of robust tubular brushed stainless steel construction and include shelves.

- c). Bumper guards shall be mechanically attached to the wall panels within the luggage rack/tower to prevent damage to walls or luggage.
- d). The rack/tower shall incorporate suitable brackets for handling garment bags. Golf bags and other larger items shall be able to be stored in this area.
- e). This feature shall only be present in luggage racks located in the baggage car.
- f). The luggage rack/tower shall be a convertible unit that can be reconfigured to hold two bicycles.
 - i). This feature shall only be present in luggage racks located in the baggage car.
- g). All surfaces shall be smoothly finished to prevent damage to luggage or passenger injury.
- h). Each luggage tower shall be equipped with 3 tiers of folding, tubular luggage racks.
 - i). The racks shall pivot at the inner walls to allow them to be stowed to accommodate varying sizes of luggage/cargo.
- i). The load bearing surface shall be inclined upward at an angle of 3° to 4°.
- j). Steel cables enclosed in weather resistant jacket shall provide for each folding shelf as secondary support.
- k). The lowest rack keeps baggage off the floor, protecting it from water, dust, etc. on the room floor.
- l). Dividers are included between the luggage towers to compartmentalize cargo, so it does not shift.
- m). Luggage racks and supporting structure shall be made of stainless-steel transversal tubing, with a raised edge for luggage retention.
- n). The racks shall have sufficient strength to support a load of 250 pounds midway between adjacent supports with a deflection not to exceed 1/4 inch and without permanent deformation. This shall be demonstrated at FAI.
- o). Two passive ¼ turn latches shall be provided to stow each of the racks in the raised position. The luggage racks shall be easily moveable with one hand to stow or deploy.
- p). Rack design and shelf dimensions shall provide the flexibility of having:
 - i). all luggage racks lowered for luggage handling any rack lowered for luggage handling
 - ii). all the luggage racks stowed.
 - iii). enable bicycles to be secured when all luggage racks are stowed.

- iv). racks of different luggage towers function mutually independently of each other
- q). Rutland Industries, Mini-Mum model # MMW2XMHV or Amtrak approved equivalent for securing bicycles shall be provided along the inner walls folding out as needed to support a bicycle hung on it.
 - i). An instruction placard shall be provided on the wall adjacent these racks, giving instructions for proper rack use.
- r). The fully loaded luggage racks and bicycle rack, mounting hardware and associated structure shall meet the strength requirements per APTA SS-C&S-034-98 for equipment support as well as RP-C&S-006-98 for attachment strength.
- s). Due to anticipated harsh environment exposure, rough handling of luggage/cargo, the luggage racks, bicycle racks and associated support structure and mounting hardware shall be robust and corrosion resistant.
 - i). They shall be simple in design, operation, and maintenance without the need for springs, dampers, etc.
 - ii). Likewise, the interior walls, bulkheads and cargo nets shall be designed for durability in handling heavy luggage and various sizes of bicycles.
 - iii). The entire baggage room installation of racks shall be designed, manufactured, and installed to prevent rattles, etc, resulting from car movement at any speed.
 - iv). All exposed fasteners in the area shall be countersunk or flush mount types to preclude any damage to passengers' luggage.
 - v). All edges and corners shall be rounded with generous radii. Bump strips shall be incorporated along the sides of each of the spaces to avoid scuffing the wall finish or the luggage.
- t). Design of the luggage towers and bicycle racks shall be subject to design review. The final interior equipment, arrangement, dimensions, and locations shall be developed during design review, with the aid of mockups.

11.75 Utility Car - Gun Locker

- a). Gun Case Modules (GCM) shall be provided in the baggage section of the utility car. The GCM shall occupy half of one baggage module section and replace the shelves.
 - i). Two GCM shall be provided in the baggage area of the utility car.
 - ii). The top of the unit shall serve as a baggage shelf and must be configured so that items cannot fall between the unit and the car wall.
 - iii). The GCM shall be a substantial device of welded construction fabricated primarily of 0.25" boiler plate steel.

- iv). The GCM shall be fastened to the car utilizing the floor mounted and wall mounted Unistrut tracks.
- v). The bottom of the unit shall be configured so that it can be handled into position with a pallet jack.
- vi). All fastening to the car shall be located inside the GCM so that a locked case cannot be removed from the car.
- vii). The exterior of the case and the installation in the car shall be such that a chain or cable cannot be hooked or wrapped around the case or any part of the case.
- viii). The case shall have two hinged doors of 0.25 inch boiler plate steel sufficiently reinforced so as to prevent bending when attacked with a crow bar or railroad lining bar, A&K model 32A, 1.5" square or railroad claw bar A&K Model 80-A.
 - (1) The doors shall be inset into the case so that the edge of the door cannot be picked for prying.
 - (2) The doors shall be hung with heavy duty continuous hinges welded to the case and door. The hinge barrel shall be recessed so that it cannot be pried, and the pin welded or shielded from being driven out.
 - (3) One door shall use spring latches to the inside top and bottom, cabled together for unlocking.
 - (4) The same door shall include a single staple to receive a 7/16" shank padlock.
 - (5) The door shall include a 0.25" vertical bar welded to the face adjacent to the padlock staple to provide recess and prying prevention on the second door.
 - (6) The second door shall include an offset section to close over the first door and capture it. The overlap section shall include a lock pocket to hold a single Medeco controlled key hockey puck style padlock.
 - (7) The door shall have a panel latch to secure the upper and lower edges.
 - (8) The latch shall have sing fold down tee handle actuation.
- b). The interior of the case shall be configured to hold shotgun cases up to 60" long standing upright and shelf area for holding pistols and ammunition cases.
 - i). The shotgun area shall have sufficient padding, securement straps, and elastic cords to prevent the cases from moving during transit.
 - ii). The bottom of the case shall be lined with 1" closed cell silicone foam to cushion the cases and prevent their sliding during transit.

- c). The entire case shall be grit blasted to remove all slag and mill scale. All corners shall be ground smooth, and edges broken and deburred.
- d). The entire case, inside and out, shall be primed with DuPont Corlar epoxy to a dry film thickness of 3 mils and finished with DuPont Imron to match Federal Standard 13655 Yellow to a dry film thickness of 2 mils.
- e). The final arrangement of the GCMs and their application to the cars will be determined during the design review process.

11.76 Utility Car - Storage Areas

- a). General
 - i). The utility car baggage area shall also serve as a storage area for additional trash, electrical equipment, and as a location for supply storage to be distributed throughout the car.
 - ii). Please refer to Chapter 1 for information regarding quantity of storage units desired across the trainset and suggested layouts.
 - iii). Utility cars shall also include the electrical cabinets and storage lockers, as described below.
- b). Electrical Cabinets
 - i). See Chapter 15 for details.
- c). Storage Lockers/Closets
 - i). Storage lockers shall be locked with crew keys or as otherwise approved by Amtrak.
 - ii). Storage lockers shall match the CMF of the adjacent wall paneling and countertop surfaces.
 - iii). Please refer to the attached CMF document (Exhibit F-2) for exact color, material, and finishes desired in each storage area. Please also refer to Chapter 19.
 - iv). Storage Lockers/Closets include the following:
 - (1) Trash Storage
 - (a) See Section 11.17 for details.
 - (2) Linen Storage Closets
 - (a) See Section 11.18 for details.
 - (3) Consumable Supply Storage
 - (a) See Section 11.19 for details.

- (4) Cleaning Supply Storage
 - (a) See Section 11.20 for details.
- (5) Dirty Linen Storage
 - (a) Dirty or used linens shall be stored exclusively in the utility car for ease of unloading at designated laundry stops.
 - (b) Used linen storage shall come in the form of a large hamper that can be easily stored or carried off the car.
 - (c) The reserved area shall be large enough to store up to 6 days of used linens throughout the trainset. This includes tablecloths, napkins, pillowcases, sheets, etc.
 - (d) Exact dimensions and configuration for dirty linen storage shall be developed in conjunction with Amtrak during the design review process.

Part XII: Crew Areas

11.77 Crew Sleeper Cabin

a). General

- i). The general sleeper cabin information from Section 11.47 also applies in the crew sleeper section.
- ii). The crew sleeper provides comfortable daytime seating and night sleeping accommodations for one crew member.
- iii). In the crew sleeper, an ottoman and a seat face each other and share a window view.
- iv). The ottoman and seat adjust to create a sleeping area for one passenger. In addition to the seating and sleeping provisions, this accommodation includes a sink.
- v). A designated room for a mechanical rider shall be provided that identically resembles a crew room.
- vi). Please refer to Chapter 1 for information regarding quantity of this accommodation type desired across the trainset and suggested layouts.
- vii). To the extent possible, the Contractor shall adhere to the general arrangement images for Crew Sleeper Cabin as shown below.

b). Key Features

- i). A comprehensive list of expected features in this type of sleeper cabin is provided in Figure 11-44 and described on the following pages.

Figure 11-44: Key Features - Crew Sleeper Cabin

Feature	Short Description	Qty	Reference	Page
General Items				
Standard Sleeper Cabin Door	24" Sliding door that includes window, blind and door lock mechanism. Manual operation.	1	11.58a)	11-201
Side Window	Includes emergency egress features	1	11.58i)	11-206
Side Window Blinds	Light filtering and black out blind	2	11.58j)	11-206
Outlets	Duplex outlet with USB. See Figure 11-127 on page 11-385.	Figure 11-29	11.58o)	11-208
Master Light Switch	Light switch that can turn on or off all lights in a sleeper room	1	11.58p)	11-209
Master Control Screen	Touchscreen tablet for controlling room environment and opting into train experience features	1	11.58q)	11-209
Master Thermostat Control	Mechanical Interface control of temperature settings	1	11.58r)	11-209
Floor Heat	Heating mechanism for room	1	11.58s)	11-209
Standard Grab Bar	49 CFR 38.115 compliant handrails	1	11.58t)	11-210
Communications				
Attendant Call Button	LED Button to page Crew	1	11.59b)	11-210
Seating Area / Lower Sleeping Berth				
Standard Sleeper Cabin Seat	Seat includes fold down features to convert into bed	1	11.60a)	11-211
Standard Sleeper Arm Rest	Armrest built into sidewall	1	11.60d)	11-216
Standard Sleeper Headboard	A firmly cushioned panel behind the seat that serves as a headboard in the berth configuration.	1	11.60f)	11-217
Crew Sleeper Ottoman	Footrest that converts into portion of bed	1	11.60h)	11-217
Cup Holder	Cupholders built into side wall	1	11.60l)	11-218
Bottle Holder	Small storage location in carshell side wall	1	11.60m)	11-218
Double Leaf Sliding Fold Out Table	Table built into side wall	1	11.60o)	11-220

Figure 11-44: Key Features - Crew Sleeper Cabin (continued)

Feature	Short Description	Qty	Reference	Page
Personal Care				
Fold Out Sink	Includes sink basin, faucet, soap dispenser, 120 V outlet, sink open indicator light, towel ring, paper cup dispenser, facial tissue dispenser	1	11.62b)	11-223
Standard Sink Vanity Cabinet	Small storage cabinet above the sink, with a mirror on the front.	1	11.62f)	11-226
Sink Vanity Mirror	Mirror with boarder LED light or backlight	1	11.62f)	11-226
Handsoap Dispenser	Base for handsoap installed adjacent to the over-sink mirror.	1	11.62j)	11-228
Lotion Bottle	Lotion bottle next to sink	1	11.62k)	11-228
Towel Hook	Coat hooks that hold up to 25lbs	1	11.62y)	11-231
Towel Ring	Install near sink.	1	11.62z)	11-231
Trash				
Seating Area Trash Bin	Tip out storage for sleeper room trash.	1	11.63a)	11-237
Storage				
Wardrobe	Storage location with a door and coat rod	1	11.64g)	11-240
Coat Hooks	Coat hooks that hold up to 25lbs	2	11.64h)	11-241
Carryon Luggage Storage	Storage cubby for carryon sized luggage	1	11.64i)	11-241
Under Seat Storage	Open space for carryon sized luggage	1	11.64j)	11-242
Sidewall Cubby	Storage location in carshell side wall	1	11.64n)	11-243
Linen Cabinet	Storage location with a door	1	11.64t)	11-245
Jacket Closet	Storage location with a door and coat rod	1	11.64u)	11-245
Clothing Cabinet	Storage location with a door	1	11.64v)	11-245
Drawers	Storage drawers	1	11.64w)	11-245

c). Functional Elements

i). Seat to Berth Conversion

- (1) A simple unlatch mechanism is required to convert the seat and ottoman into a bed/berth.
- (2) This should be positioned in a place that is easy for people to use and designed in a way so that people can understand its purpose.
- (3) The latch should be free for jamming and free from any finger trap hazards.
- (4) Conversion of seat and ottoman to berth shall result in an entirely flat sleeping surface.
- (5) The mattress surface should be integral to the back of the seat.
- (6) A single seam between the bed surface is acceptable with a single thin topper to finish the bed surface.
- (7) There shall be no movement in the berth structure under full loading conditions when the berth is deployed.
- (8) Berth Dimensions: Minimum width 27" x Minimum length 77"

d). Lighting

i). General

- (1) Lighting general information is shared in the points below.
- (2) Approximate lighting locations and types are shown in the following Figures:
 - (a) Figure 11-128: Crew Sleeper Wash Light Locations
 - (b) Figure 11-129: Crew Sleeper Spot Light Locations
 - (c) Figure 11-130: Crew Sleeper Ceiling Pool Light Locations
 - (d) Figure 11-131: Crew Sleeper Compartment Light Locations
 - (e) Figure 11-132: Crew Sleeper Reading Light Locations

ii). Wash Lights (RGB Lights)

- (1) Wall wash lights for the aisle partition wall and the back walls behind the seats shall be provided along the length of each wall.
- (2) Ceiling wash lights shall run the length of the room along the window line. This light shall function to illuminate the ceiling.
- (3) See Figure 11-128 on page 11-386.

- iii). LED Panel Spot Lights (White Lights)
 - (1) Two small circular LED light panels shall act as spot lights at the entrance door (see Figure 11-129 on page 11-387).
 - (2) The frame for the spot lights shall be color matched to the ceiling.
- iv). Ceiling Lighting in the Crew Sleeper (RGB Light)
 - (1) A feature pool light shall be central to the ceiling (see Figure 11-130 on page 11-387). This shall provide indirect wall washing across the ceiling at the center of the room.
- v). Compartment Light (RGB Lights)
 - (1) Carryon Luggage Cubby shall have a strip of indirect lighting to illuminate this cubby and the inside of the luggage storage area.
 - (2) Linen Closet shall have a strip of indirect lighting to illuminate this closet and shall activate when the door is opened.
 - (3) Jacket Closet shall have a strip of indirect lighting to illuminate this closet and shall activate when the door is opened.
 - (4) Wardrobe shall have a strip of indirect lighting to illuminate this closet and shall activate when the door is opened.
 - (5) Clothes Cabinet shall have a strip of indirect lighting to illuminate this closet and shall activate when the door is opened.
 - (6) Under Seat lights shall be provided as indirect lighting that spills out across the floor under the seat.
 - (7) Sink- A wash light should be used to light the sink area that is automatically activated when the sink is deployed
 - (8) Vanity shall include an internal light source that activates when the door is opened.
 - (9) Light locations for the Crew Sleeper Compartment are illustrated in Figure 11-131 on page 11-388.
- vi). Reading Light (White Lights)
 - (1) Upper reading lights shall be embedded into the ceiling panel above the berth.
 - (2) These should be mini panel lights.
 - (3) Reading light switches should be located next to the reading light.
 - (4) Lower reading lights shall be provided at the seated position and the ottoman above the desk position.

- (5) The light itself shall be adjustable so that the passenger can adjust the direction to position the light over their reading material.
- (6) Reading light switches should be located next to the reading light.
- (7) Reading light locations for the Crew Sleeper Compartment are illustrated in Figure 11-132 on page 11-389.

11.78 Conductor Office

- a). Conductor office location shall be centrally located in the trainset.
- b). A conductor's office modular seating area with a workstation for one and/or two person(s) enclosed with full height wall and pocket door with window shall be provided for train crew to use as office space.
- c). A pair of duplex electrical outlets and USB ports shall be provided for the crew to use for charging of radios, cell phones and other equipment.
- d). A PA, crew IC and OTIS control station shall be provided in accordance with the requirements of Chapter 14.
- e). An overhead luggage bin may be included, fitted with a standard coach key lock.
- f). The conductor office module shall be reviewed and approved by Amtrak during Design Review.

11.79 Kitchenette

- a). General
 - i). A kitchenette area shall be provided for crew to use.
 - ii). The layout in Figure 11-133 on page 11-390 shows the desired approximate locations and relative footprints for each element of the kitchenette.
 - iii). The Contractor shall use this layout as the basis for the kitchen design and make adjustments as necessary to provide complete functionality using common elements found in the food service areas.
 - iv). The intention is to repeat identical food service modules used elsewhere in the train so that this area is not unique.
 - v). The Contractor shall submit layouts at each stage of the design review process for Amtrak's review and acceptance.
- b). Included Items
 - i). Microwave
 - (1) A purchased off the shelf item shall be provided by the Contractor that meets or exceeds the features from the example part number: Amana HDC212.

- (a) Countertop stackable microwave,
 - (b) 0.6 cu ft capacity, 2100 watts,
 - (c) heavy volume,
 - (d) 4 stage cooking,
 - (e) touchscreen
- ii). Refrigerated Cabinet
- (1) General
 - (a) This cabinet is identical to the refrigerator cabinet used in food service areas.
 - (b) Please refer to Chapter 16 for refrigeration evaluation criteria.
 - (2) Refrigerated Cabinet Temperature Control
 - (a) The temperature within the module shall be monitored and reported to wayside.
 - (b) There will be alarm annunciation to the train crew that the refrigerated display is malfunctioning if the temperature in the display case reaches 41°F for a continuous one hour period or if the temperature ever reaches 50 °F.
 - (c) The refrigerated display shall be suitably sized to bring room temperature stock down to 40 °F or lower within 90 min from startup.
 - (d) The refrigerated display shall be suitably insulated to maintain temperature within limits during a power loss of 60 min.
 - (e) The refrigerated display shall function to keep food at or below 40°F.
 - (3) Refrigerated Cabinet Condensation
 - (a) The display case will be suitably insulated to prevent all condensation from appearing on the outside of the module.
 - (b) Drainage for the refrigerated cabinet condensation shall take into account liquid spills and condensation generated by the evaporator.
 - (4) Refrigerated Cabinet Shelves
 - (a) Shelves in the refrigerated cabinet shall be mounted on drawer slides that allow ease of access and cleaning for each storage area within the refrigerated cabinet.

- (b) Shelves shall have sufficient strength to hold 30 lbs of goods.
 - (c) Shelves shall have sufficient perforations to allow for airflow within the refrigerated cabinet to maintain required temperatures.
 - (d) Shelves shall have a short raised, hemmed edge on all sides to prevent items from sliding off the shelf while the train is in motion.
 - (e) Shelf drawers shall only slide out when activated so that if the train lurches suddenly, the drawers do not slide out on their own.
 - (f) The shelf shall be mounted on sturdy, durable, cleanable drawer slides that allow for continuous cycles of opening and closing and operate smoothly.
- (5) Refrigerated Cabinet Doors
 - (a) Refrigeration cabinet doors shall be constructed from stainless-steel.
 - (b) They shall have sufficient insulation to help maintain temperatures within the cabinet and to prevent condensation on the outside of the doors.
- (6) Refrigerated Cabinet Maintainability
 - (a) Refrigeration equipment shall be easily accessible behind a plate with a grille for air flow and locked with square locks for maintenance or replacement of equipment.
 - (b) Refrigeration equipment shall be mounted on a removable skid for changeout that will constitute as the LRU for the refrigerated cabinet.
- (7) Refrigerated Cabinet Refrigerant
 - (a) Refrigerant used in the refrigeration equipment shall be presented and approved by Amtrak during PDR.
- iii). Trash and Recycling Storage
 - (1) Trash and recycling will be stored in a stainless-steel module with drawers for the trash and recycling bins to slide in and out of the module.
 - (2) The drawer shall be mounted on sturdy, durable, cleanable drawer slides that allow for continuous cycles of opening and closing and operate smoothly.
 - (3) The drawer shall operate with push to open, slam to close latches.

- (4) The stainless-steel or aluminum trash and recycling bins shall be completely sealed so that no liquid can escape the trash and recycling bin.
 - (5) These bins are intended to be removable for emptying the trash and recycling and for cleanability.
 - (6) In this food service area, the cumulative minimum internal volume for the trash and recycling required is 10 cu ft.
 - (7) The trash and recycling drawers shall be designed with cleanability features including 0.25" radii at the bottom of the drawer and there shall be no fastener protrusions into the base of the drawer.
- iv). Handwashing Sink
- (1) A sink shall be provided where the sink basin is at least (12" x 10" x 6").
 - (2) The basin and sink counterspace shall be made from welded stainless steel.
 - (3) Marine edges shall be included on the front edge of the handwashing sink area.
 - (4) A backsplash of at least 6" shall be included on the other edges of the utility sink area.
 - (5) The radius between the backsplash and the utility sink shall be at least $\frac{3}{4}$ ".
 - (6) The drain in the bottom of the sink basin shall be 1.25" in and shall be capable of being plugged with a ball valve attached to an L shaped rotational lever mechanism.
 - (7) The L shaped rotational mechanism shall extend to the front of the module so that it is easy to reach this lever.
 - (8) All requirements described in the water and waste section of this specification shall apply to the utility sink.
- v). Faucet
- (1) The faucet for the handwashing sink shall use an IR sensor to allow water to run through the faucet.
 - (2) The faucet shall be sized and shaped to allow the water to flow to the center of the handwashing sink basin.
- vi). Soap Dispenser
- (1) The soap dispenser used by Amtrak is manufactured by Celetse Industries Corporation.

- (2) The Contractor should supply the mounting base for the soap dispenser. The base is made of Delrin and is tapered.
- vii). Paper Towel Holder
 - (1) The paper towel holder shall be SanTRAL Plus PTU 31 E ST or similar.
 - (2) This shall have anti-fingerprint coating, have a filling volume of 500-600 sheets of folded paper towels, be lockable, and be wall mounted.
- viii). Countertop Workspace
 - (1) A stainless-steel workspace is required for food preparation.
 - (2) The workspace shall have 6" backsplash and 0.25" radius minimum for cleanability.
 - (3) The countertop shall be of a usable height between 36" and 38" tall.
 - (4) The countertop shall be attached to the adjacent modules with no holes for fasteners on the top of the workspace.
- ix). Crew Lockers
 - (1) Crew Storage Lockers shall be constructed from stainless-steel.
 - (2) These modules shall be designed to retain goods while the train is in motion.
 - (3) These lockers shall also include a padlock hasp for individual crew members to lock their personal items
 - (4) The crew locker cabinets shall have:
 - (a) hinged doors with stainless-steel hinges,
 - (b) push to open, slam to close latches,
 - (c) door swing limiting mechanism to prevent the doors from colliding and denting
 - (d) option for adjustable shelving to accommodate varying items
- x). Booths
 - (1) The kitchenette booths shall be identical to the standard booths used in the coach café.

11.80 Crew Restroom

- a). The restrooms for crew passengers shall be identical in every way to the STR restrooms in coach. (see Section 11.45)

11.81 Crew Shower

- a). The showers for crew passengers shall be identical in every way to the showers for sleeper cabin passengers. (see Section 11.56)

Part XIII: CDRLs

11.82 CDRLs

CDRL	Description	Due
CDRL 11-01	Human Factors Study Report	30 days prior to PDR
CDRL 11-02	Pinch Point Gap Analysis	30 days prior to FDR
CDRL 11-03	Luggage and Baggage Analysis	30 days prior to PDR

Part XIV: Figures

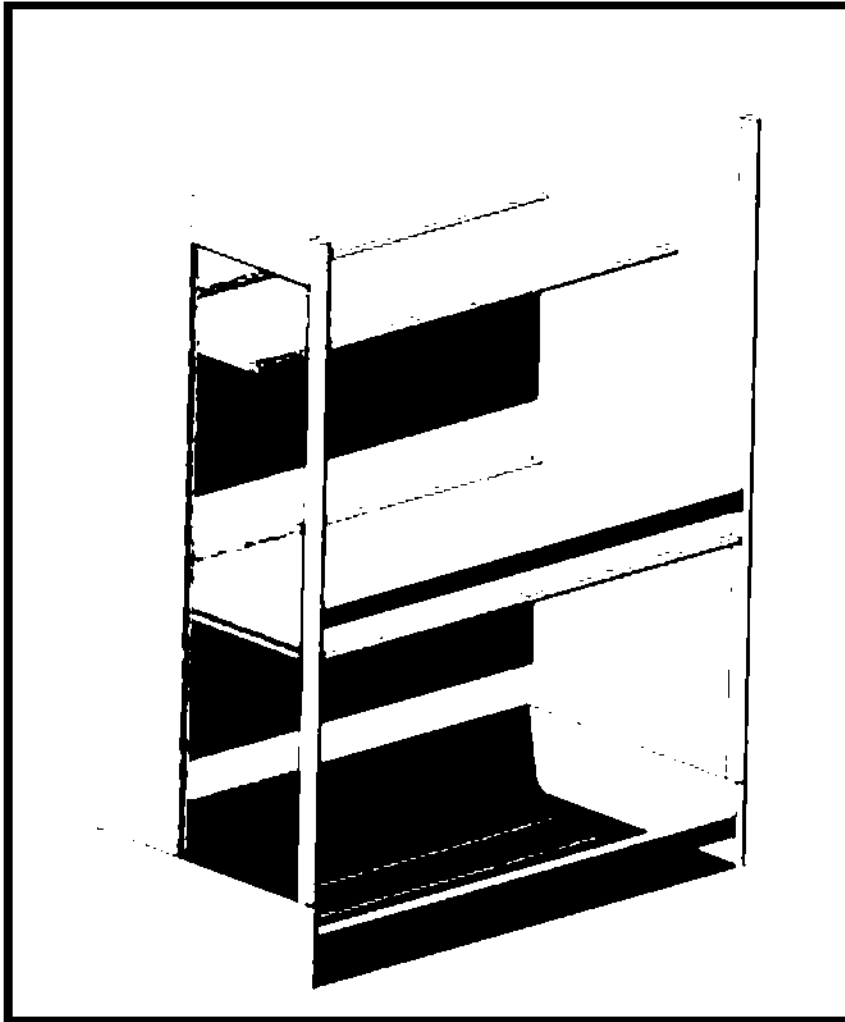

Figure 11-45: Luggage Tower 1

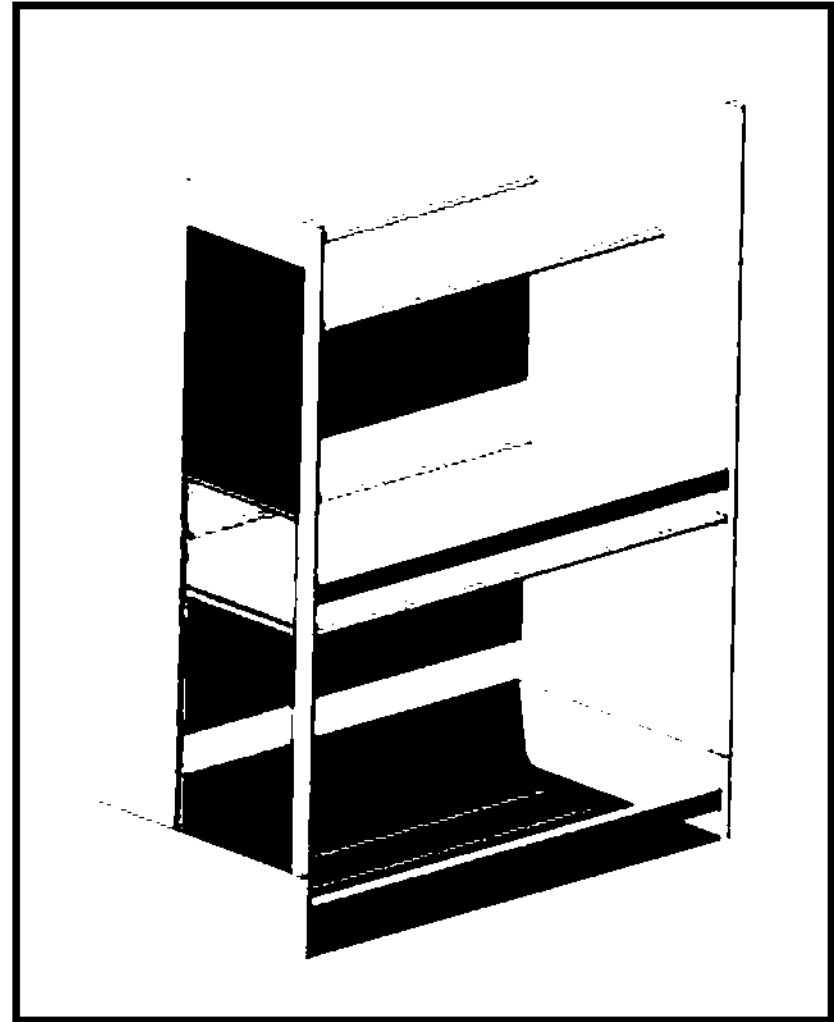

Figure 11-46: Luggage Tower 2

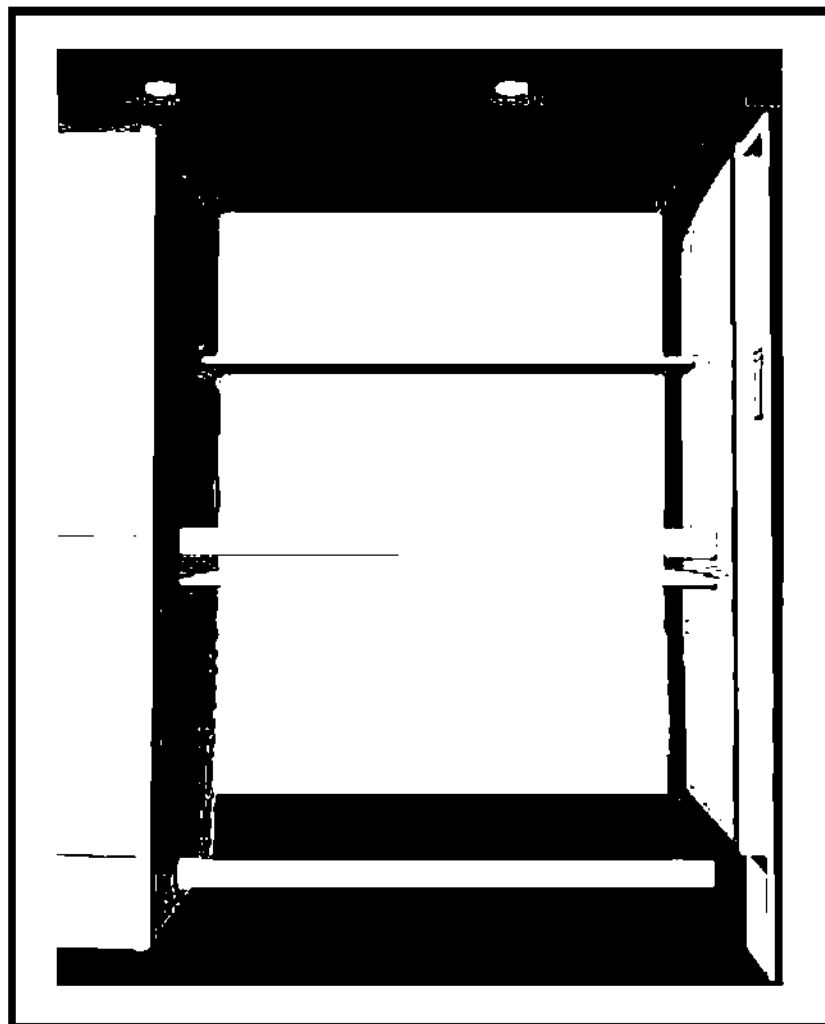

Figure 11-47: Alcove Luggage Tower

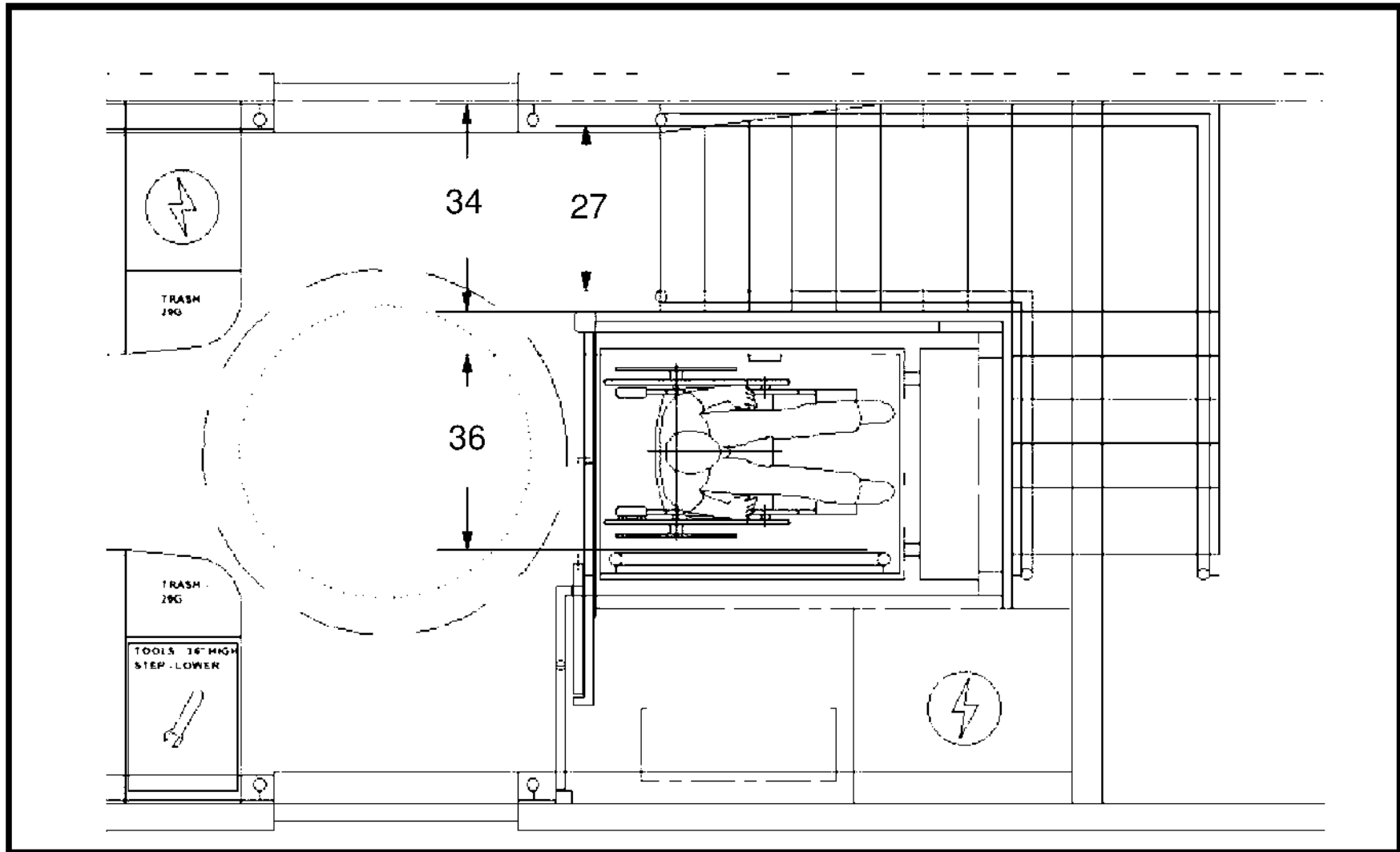

Figure 11-48: Stairway and Elevator Concept

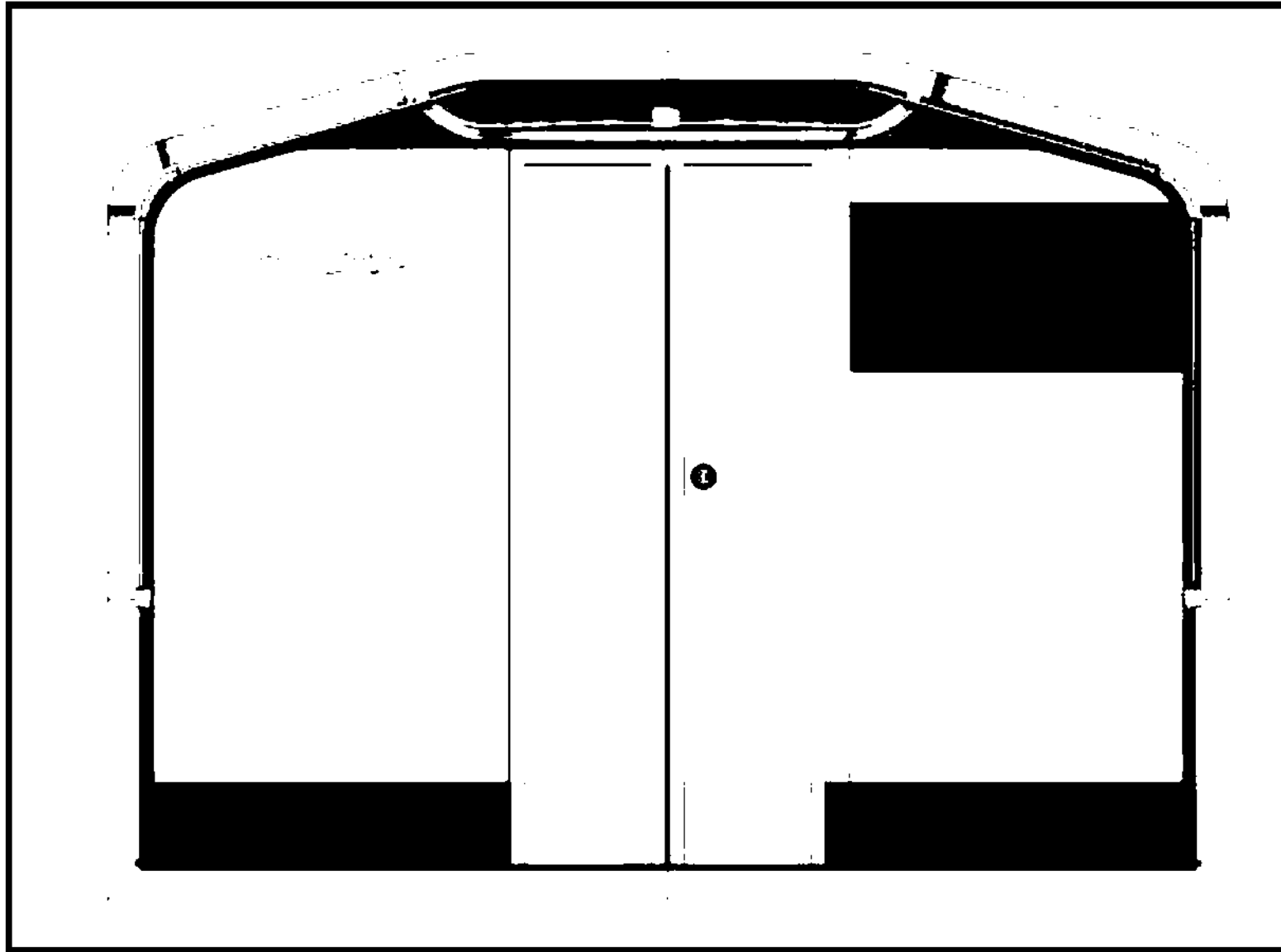

Figure 11-49: Bulkhead Walls with Doors

CONFIDENTIAL — DO NOT DISTRIBUTE

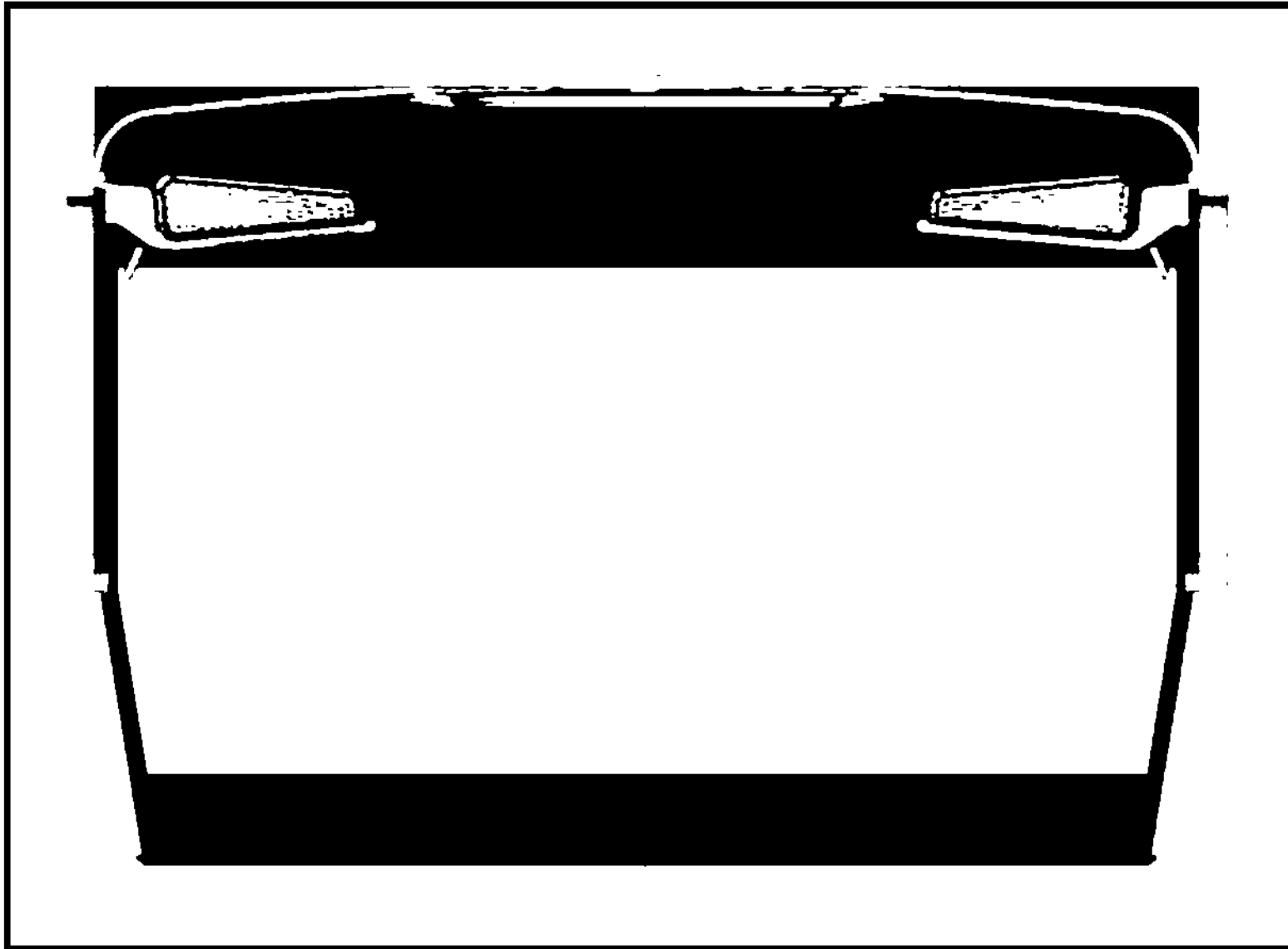

Figure 11-50: Bulkhead Walls without Doors

CONFIDENTIAL — DO NOT DISTRIBUTE



Figure 11-51: Hallways

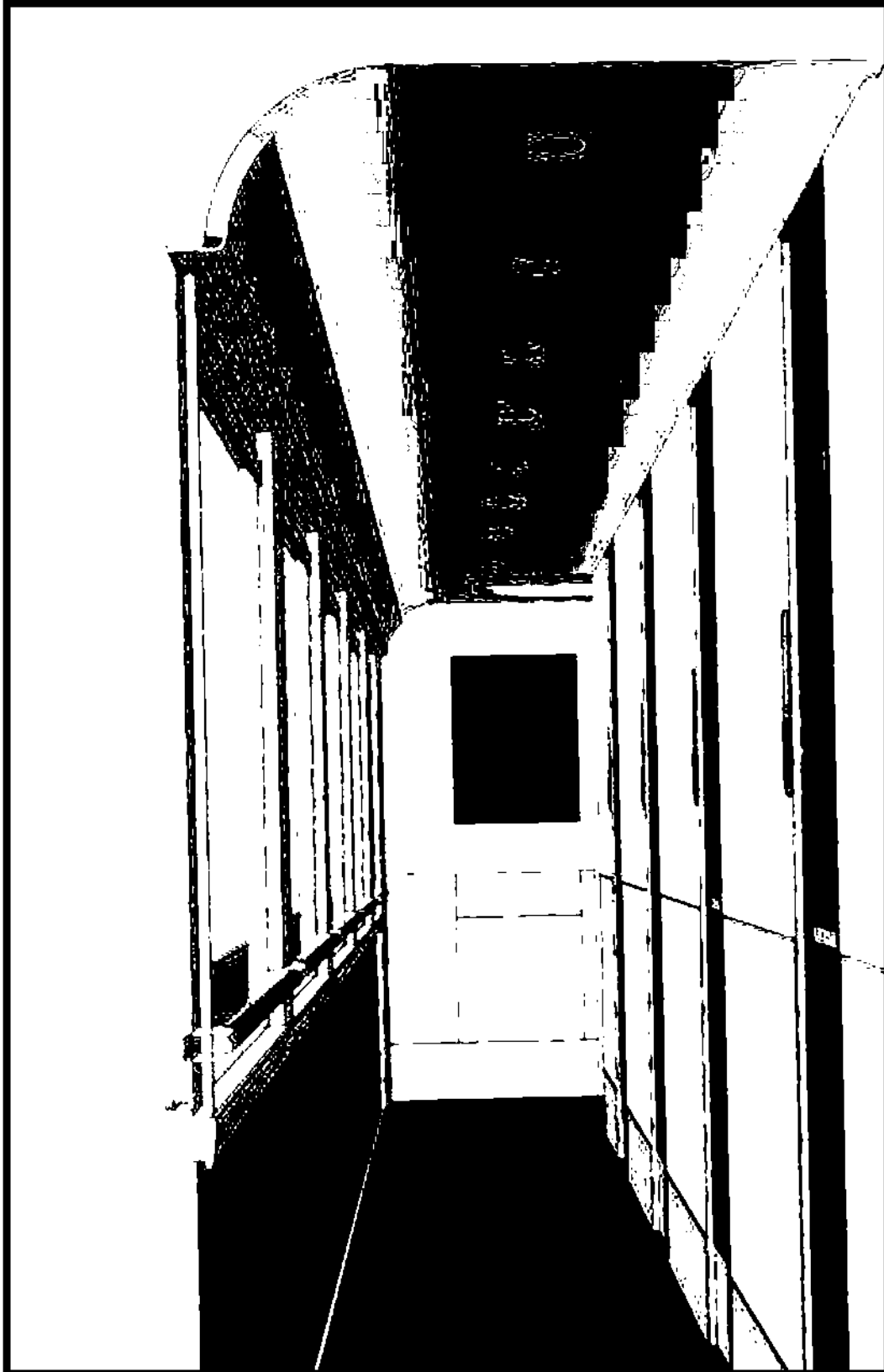

Figure 11-52: Hallway Light Locations

CONFIDENTIAL — DO NOT DISTRIBUTE



Figure 11-53: Entrance Areas

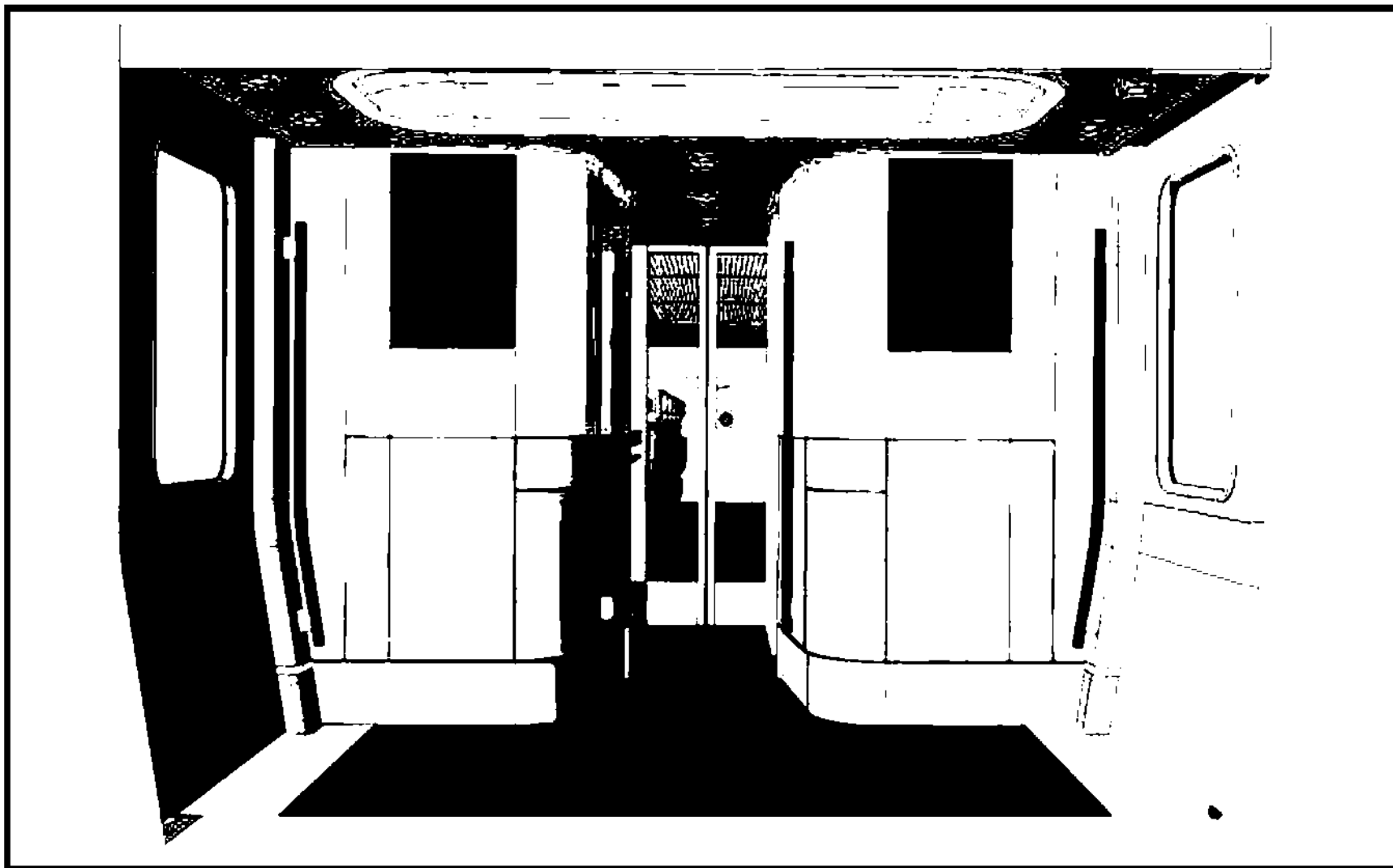

Figure 11-54: Entrance Area Light Locations

CONFIDENTIAL — DO NOT DISTRIBUTE

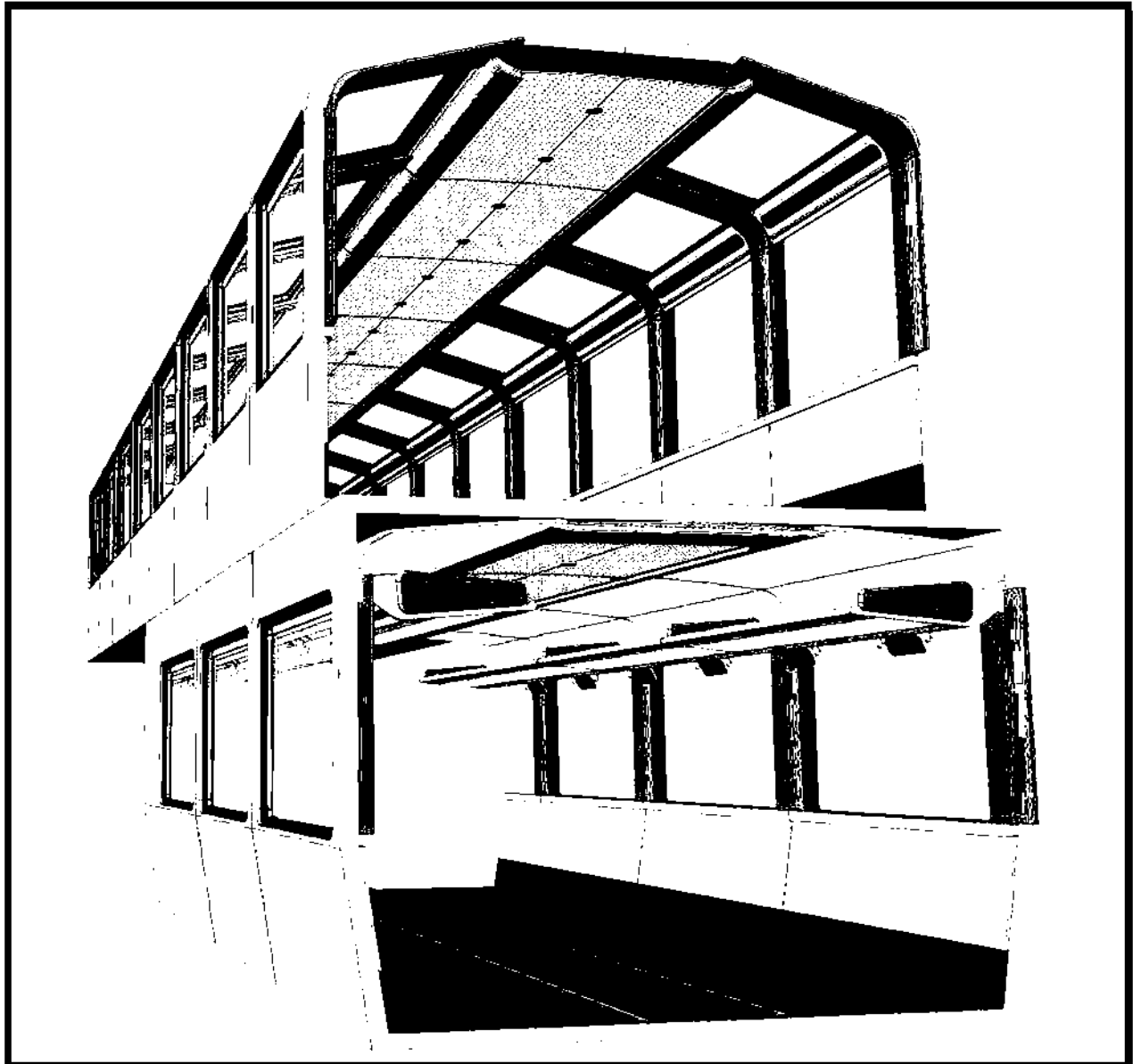

Figure 11-55: Coach Interior Structure

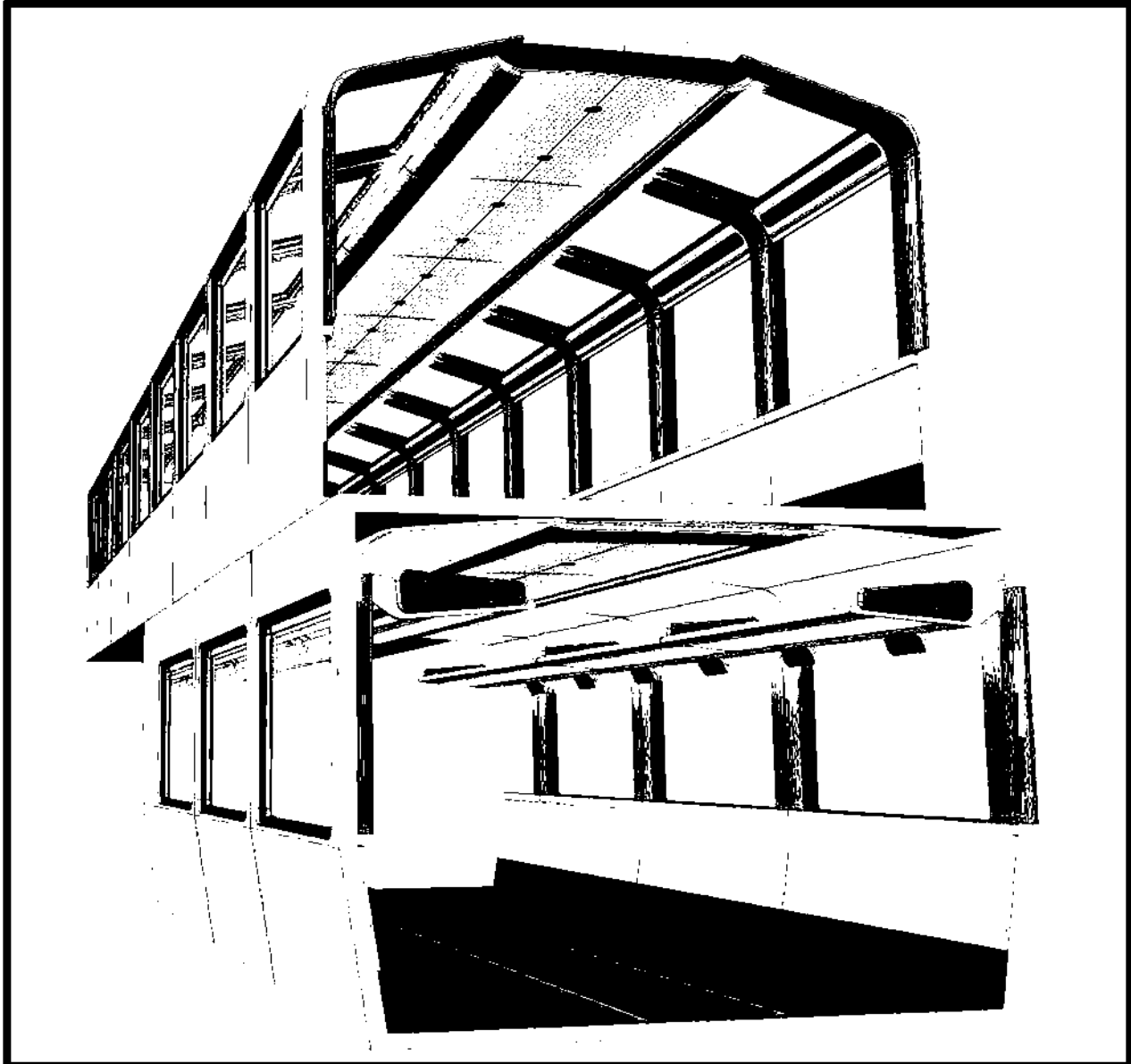

Figure 11-56: Coach Light Locations

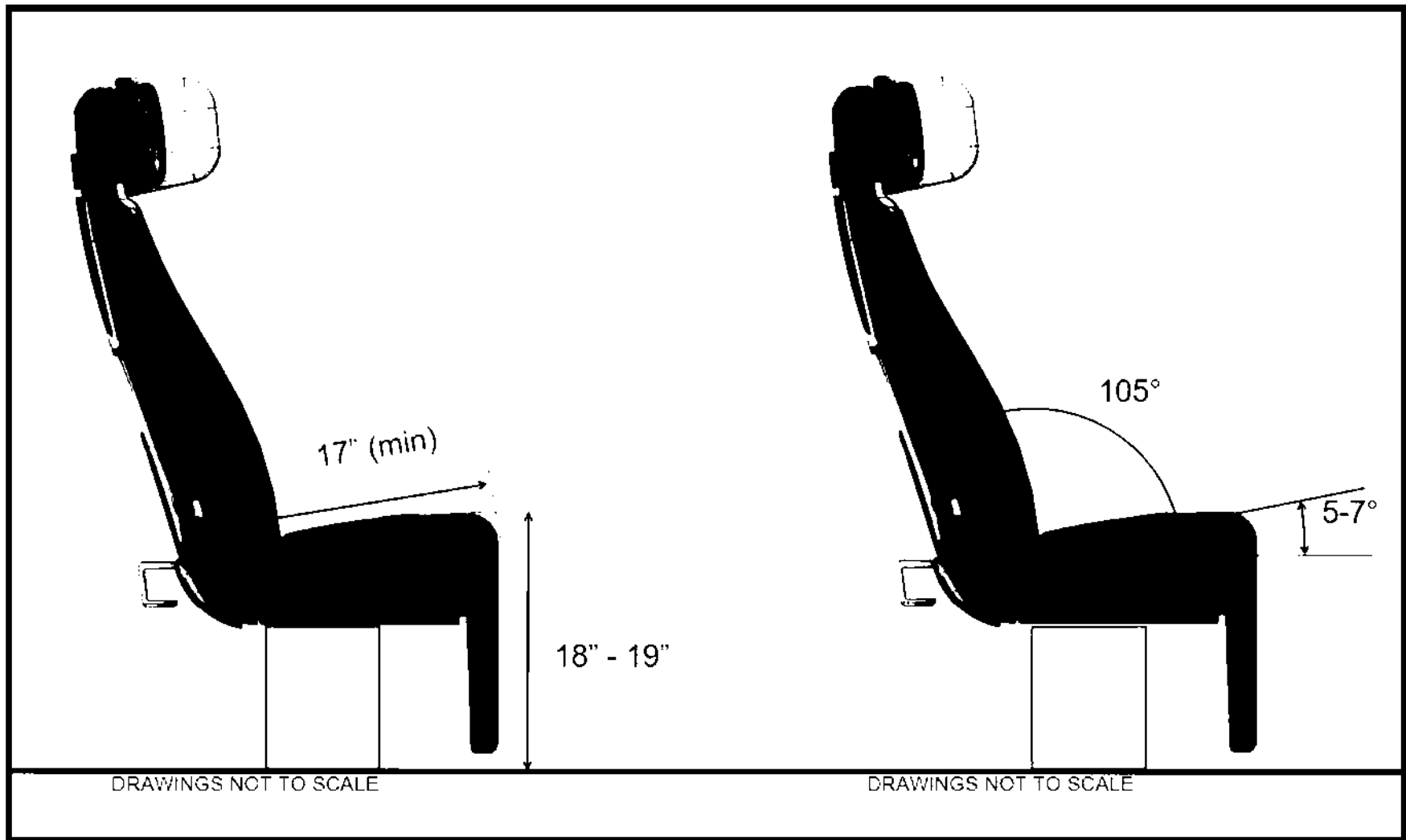

Figure 11-57: Standard Coach Seat Dimensions

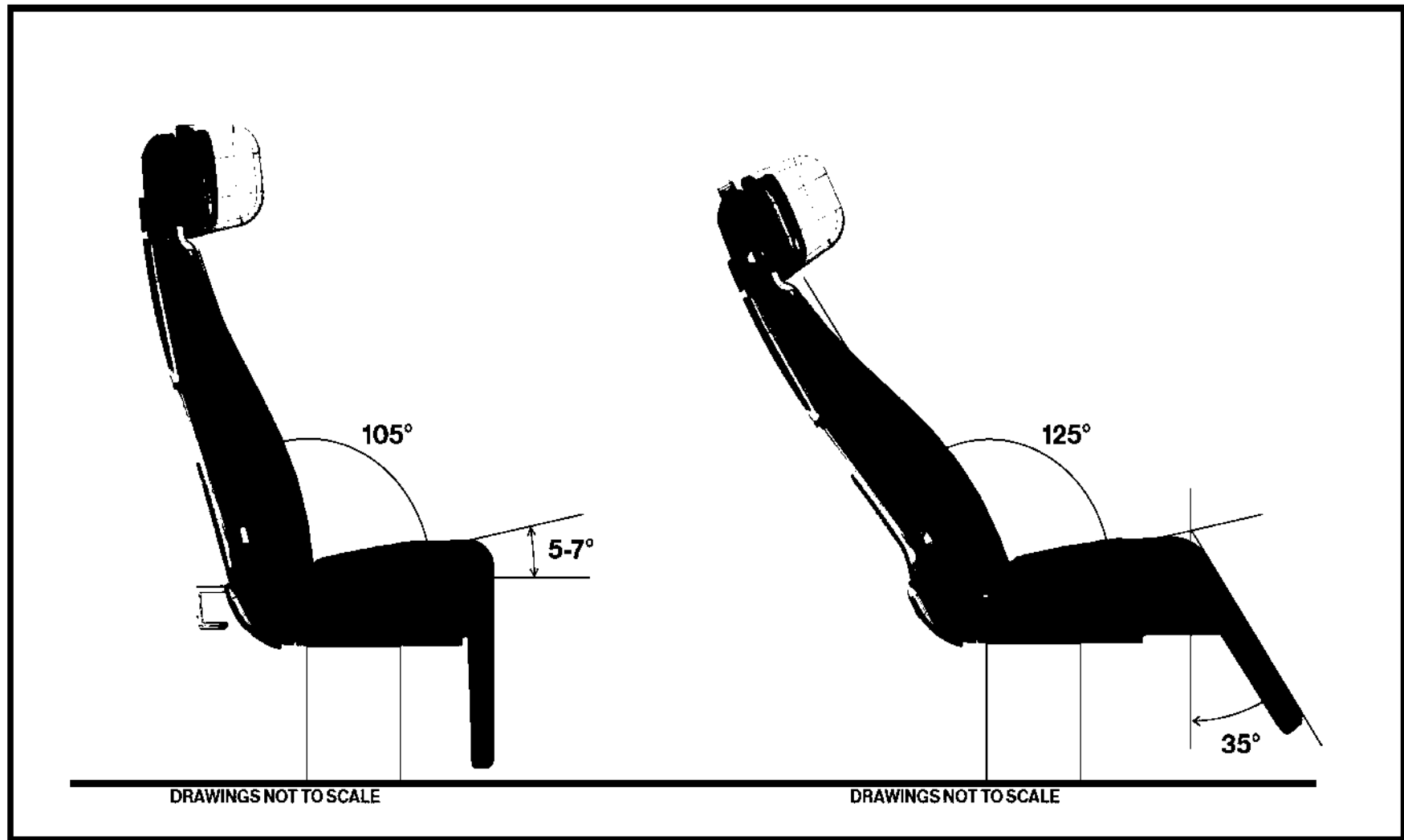

Figure 11-58: Standard Coach Seat Recline

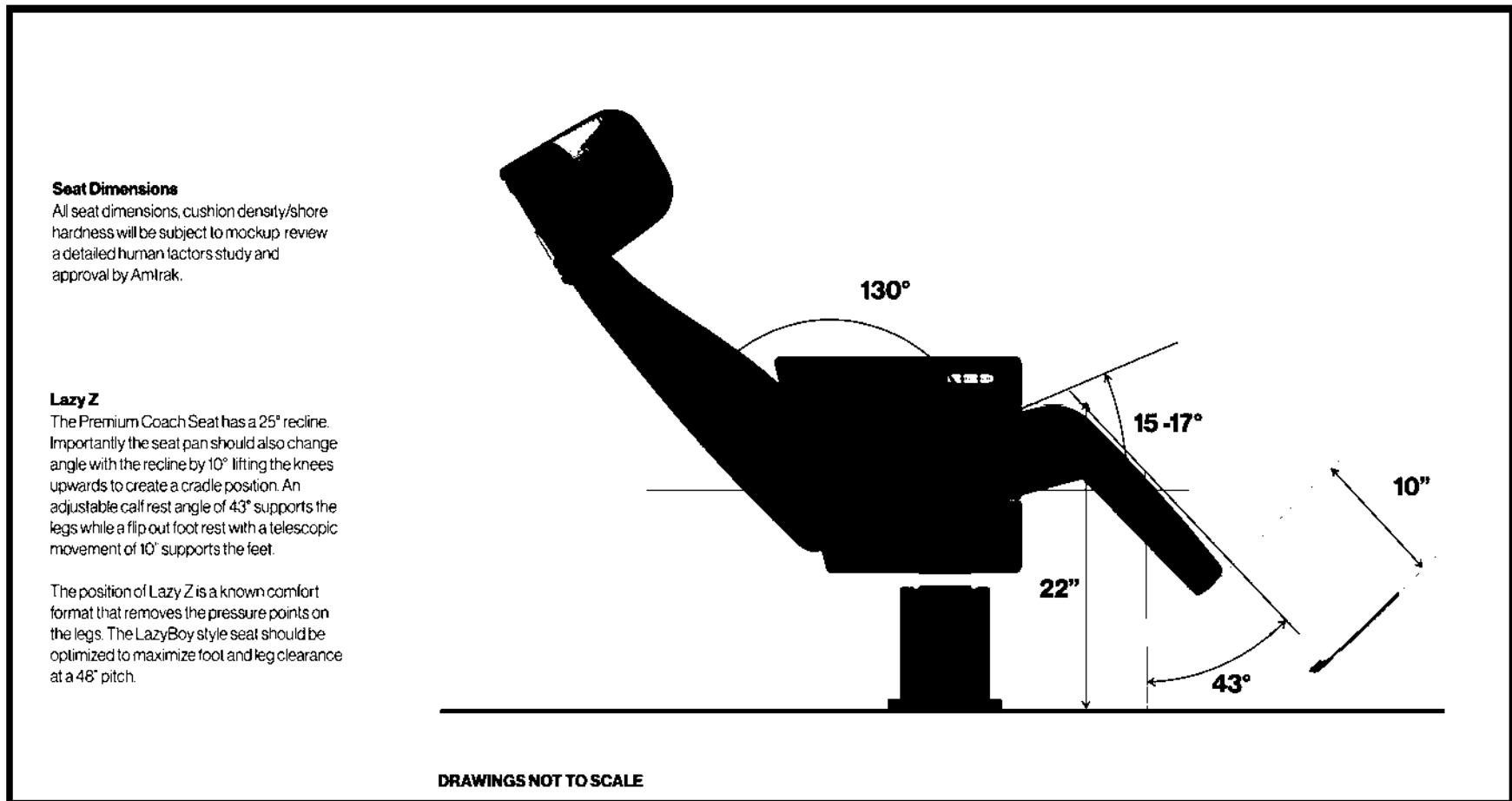

Figure 11-59: Premium Coach Seat Dimensions

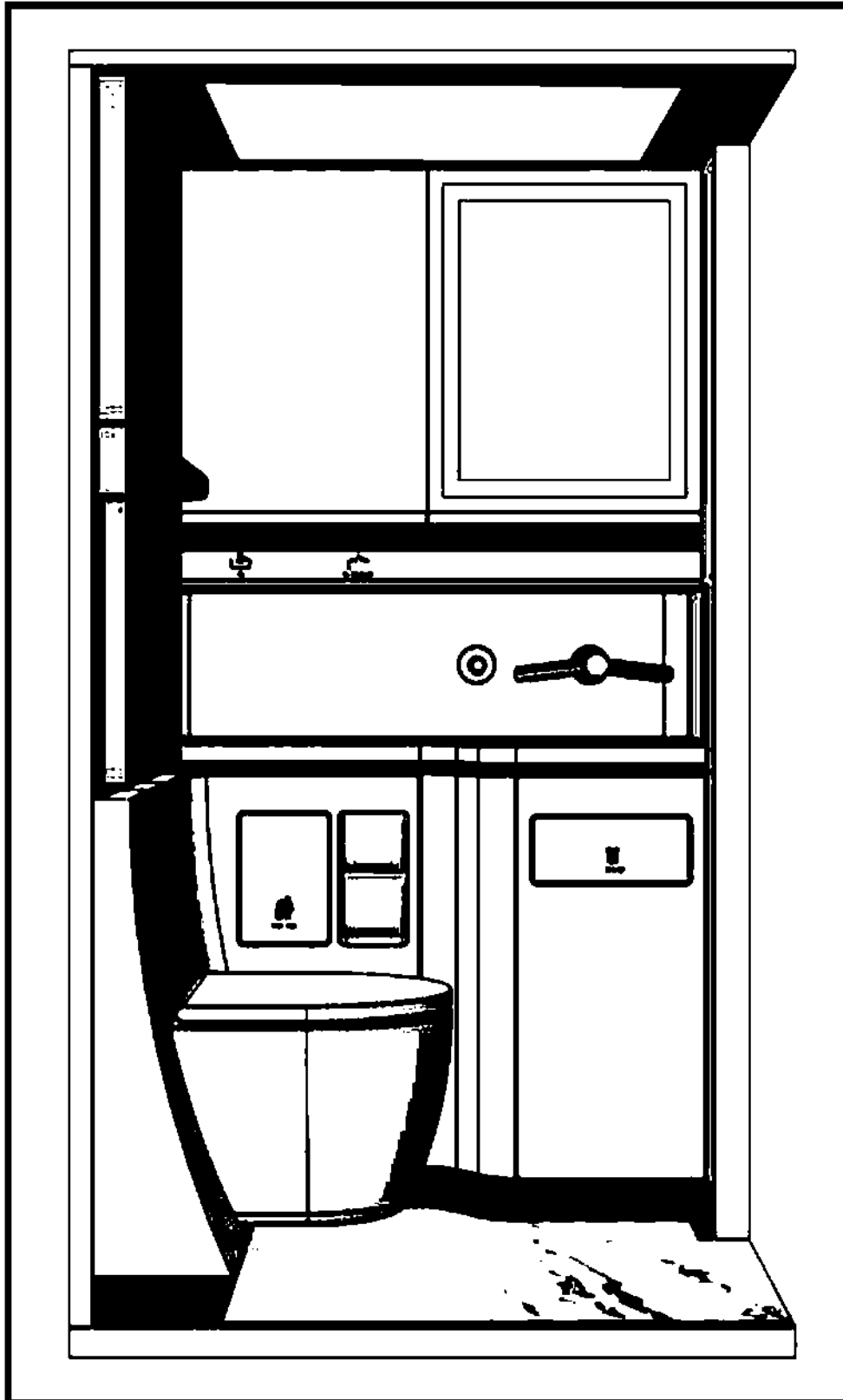

Figure 11-60: STR - Standard Toilet Room

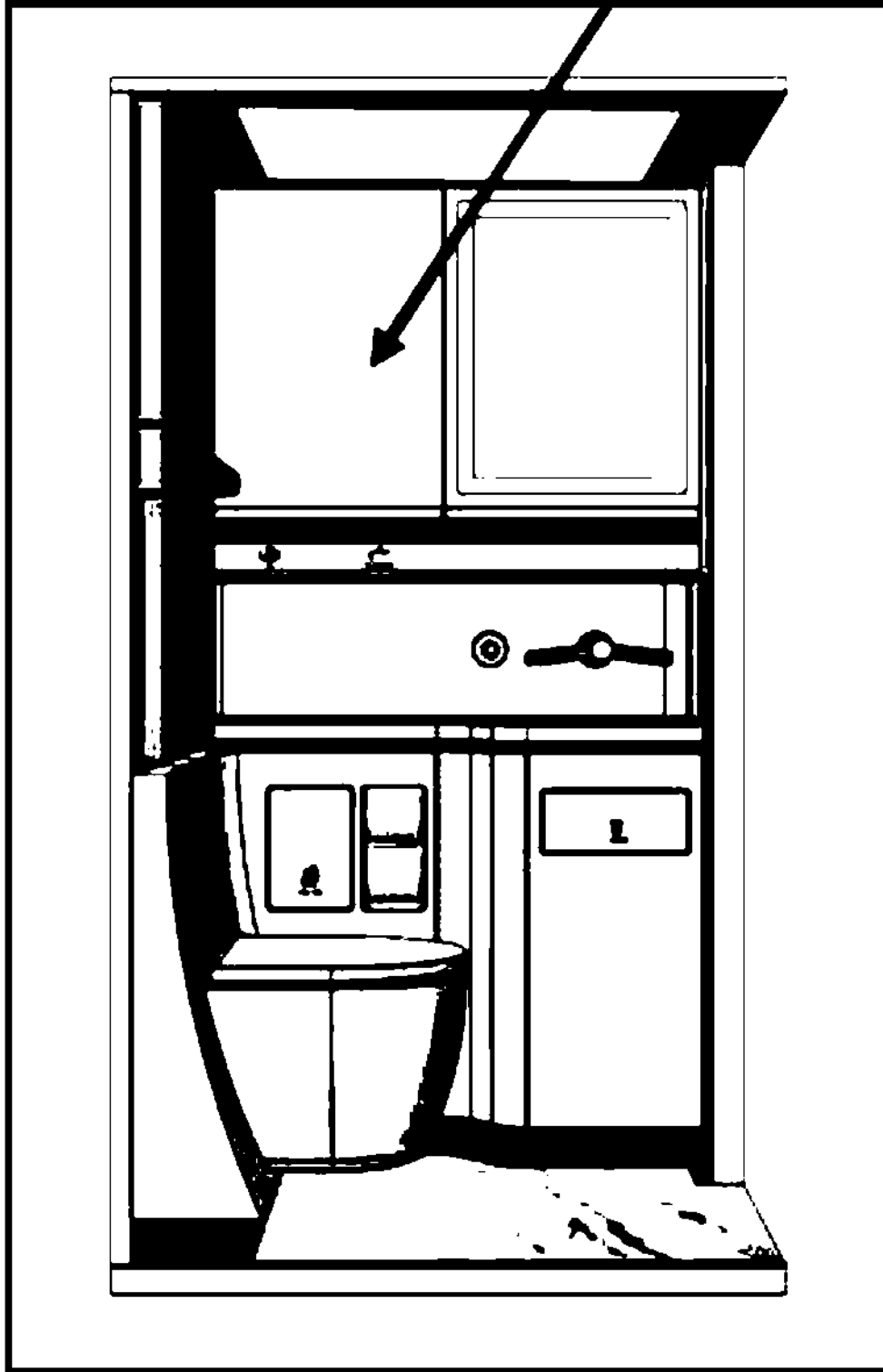

Figure 11-61: STR - Outlet Locations

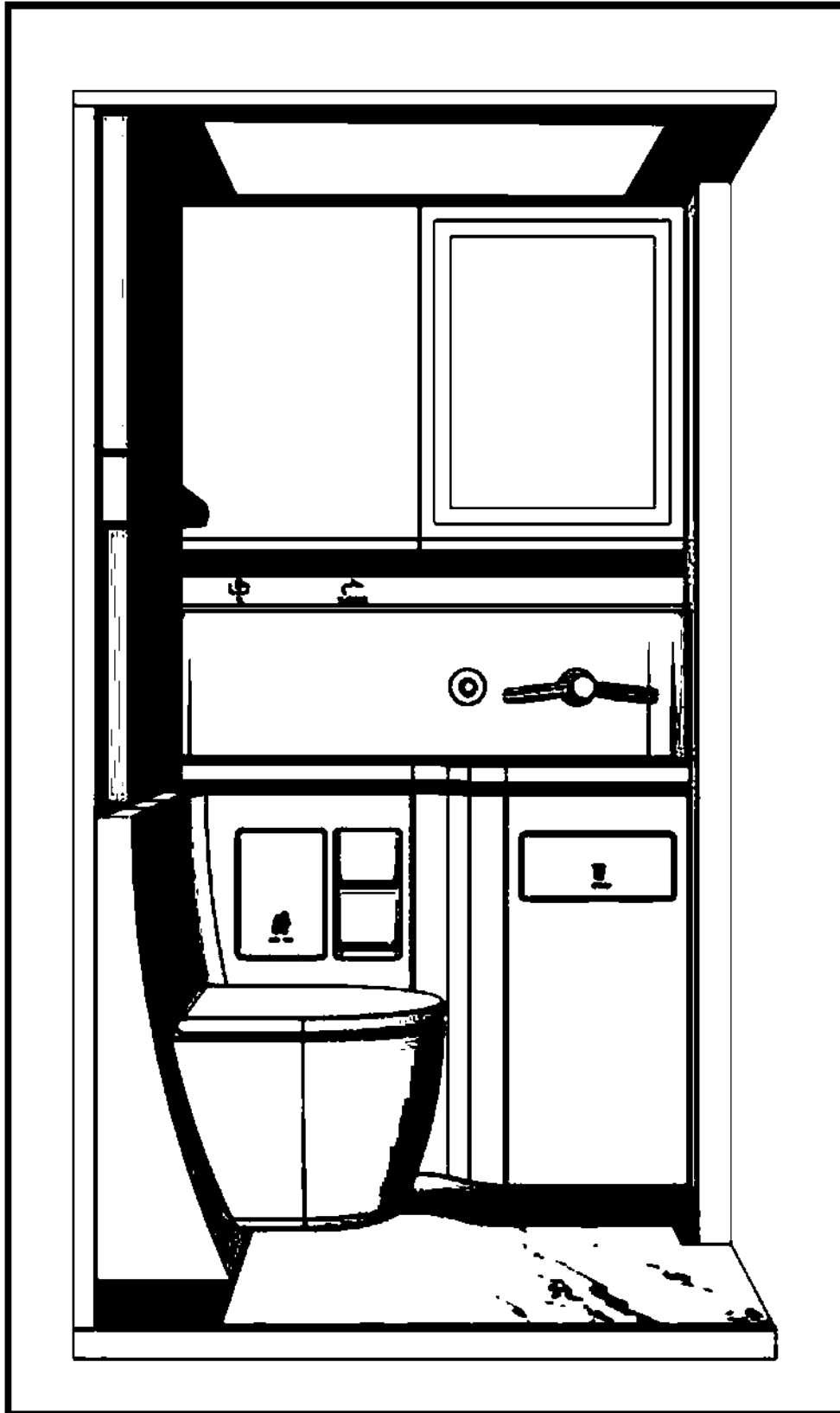

Figure 11-62: STR Light Locations

CONFIDENTIAL — DO NOT DISTRIBUTE

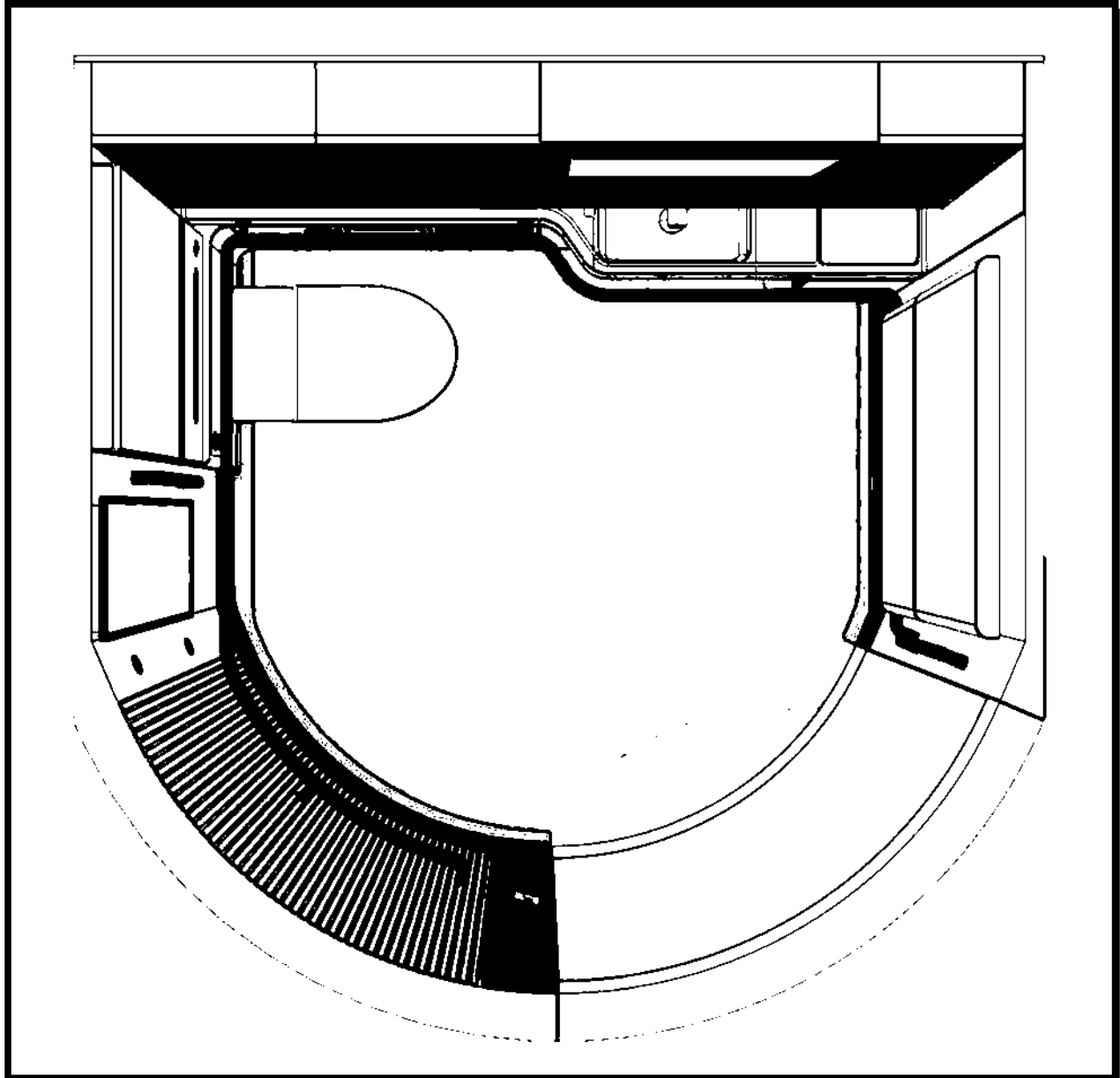

Figure 11-63: ATR - Accessible Toilet Room

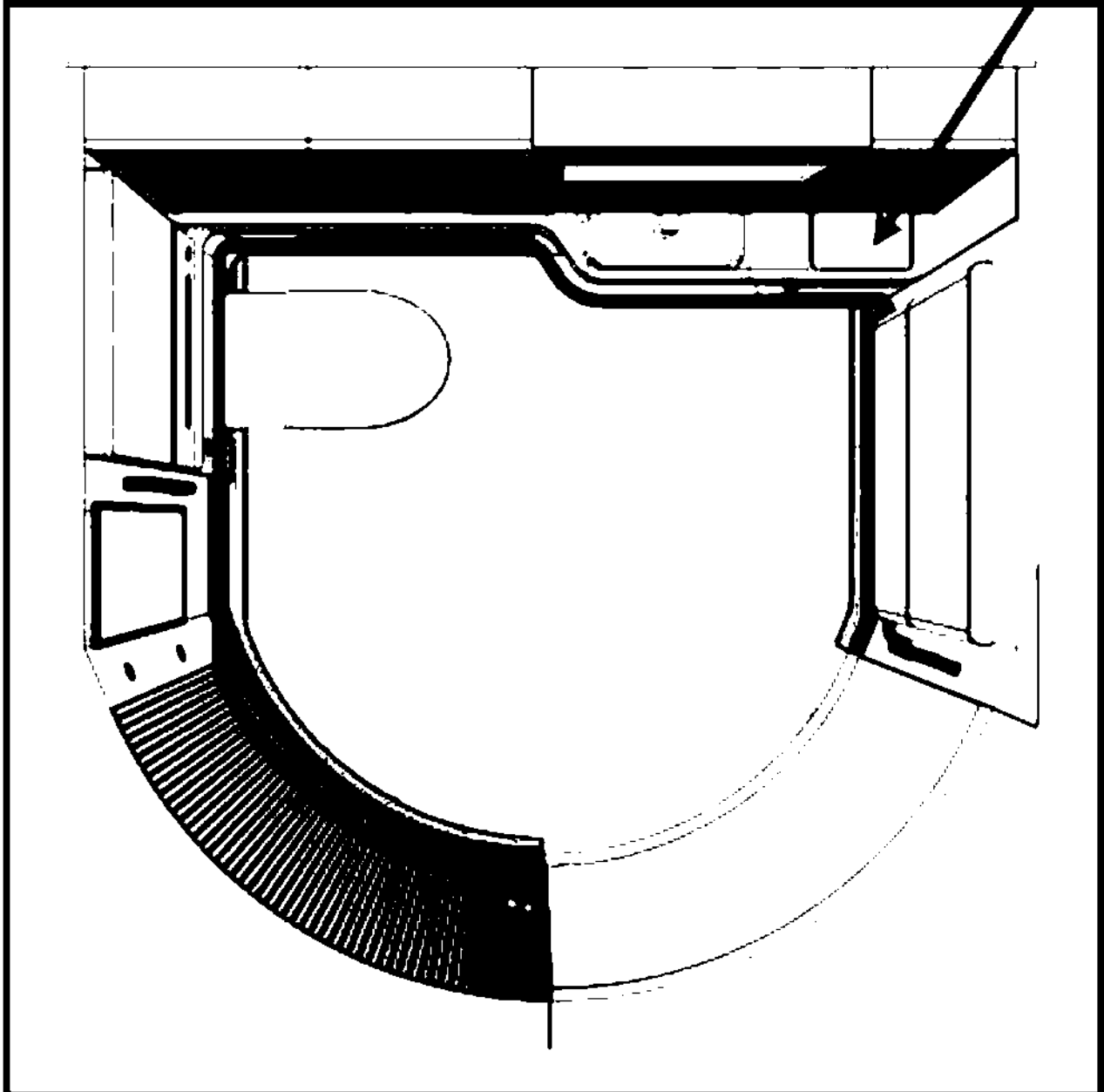

Figure 11-64: ATR Outlet Locations

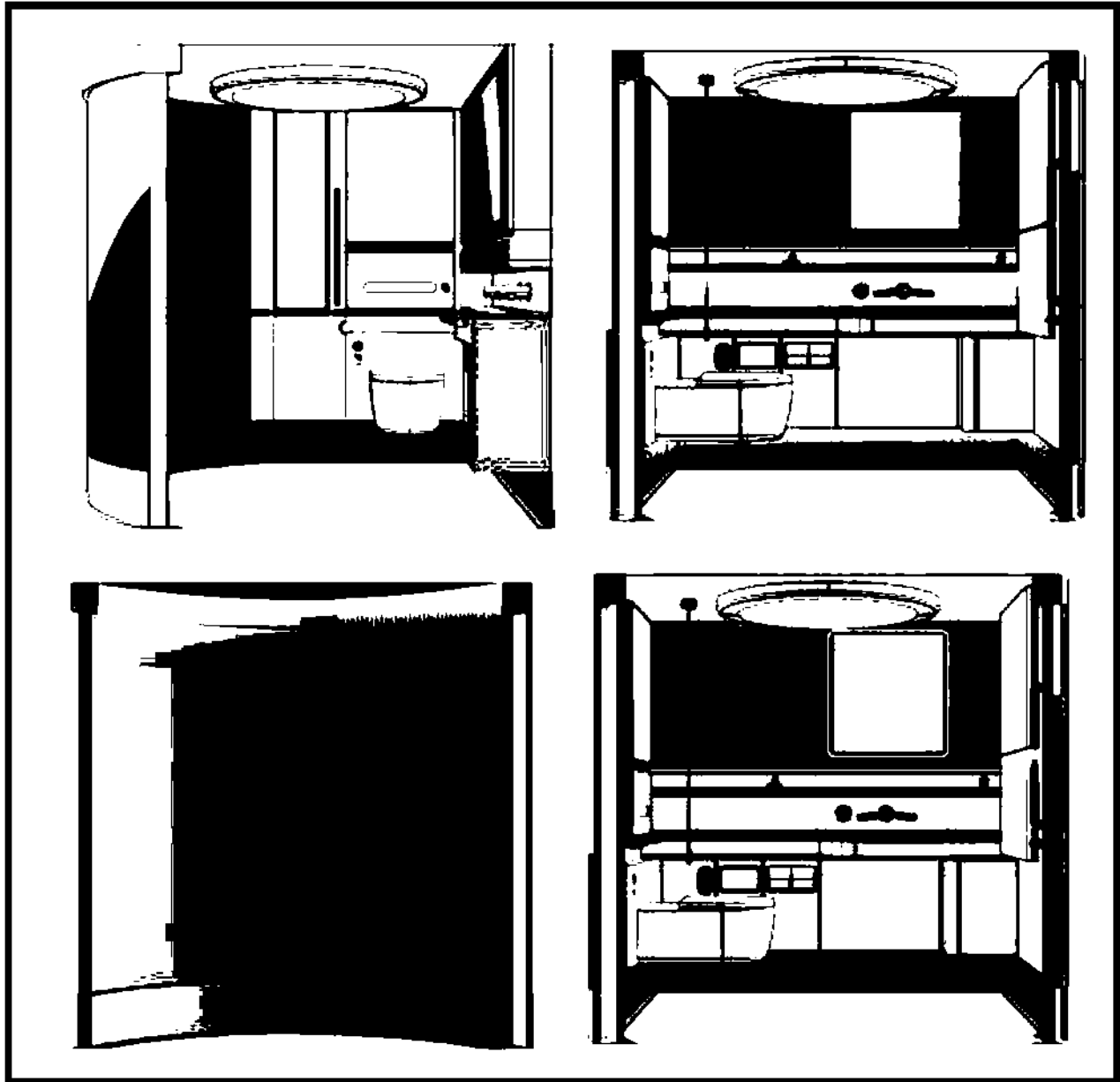

Figure 11-65: ATR Light Locations

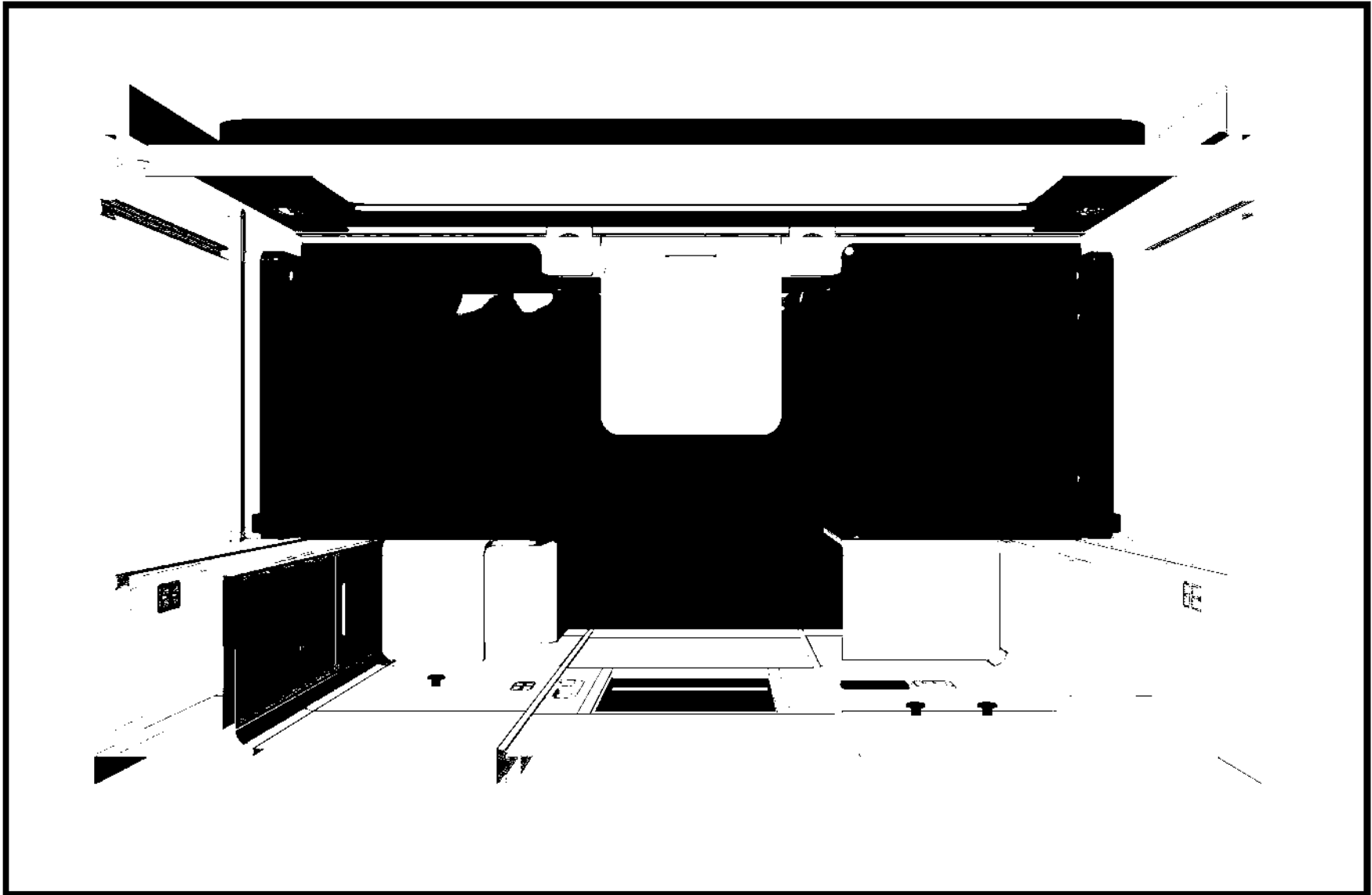

Figure 11-66: Roomette Cabin

CONFIDENTIAL — DO NOT DISTRIBUTE

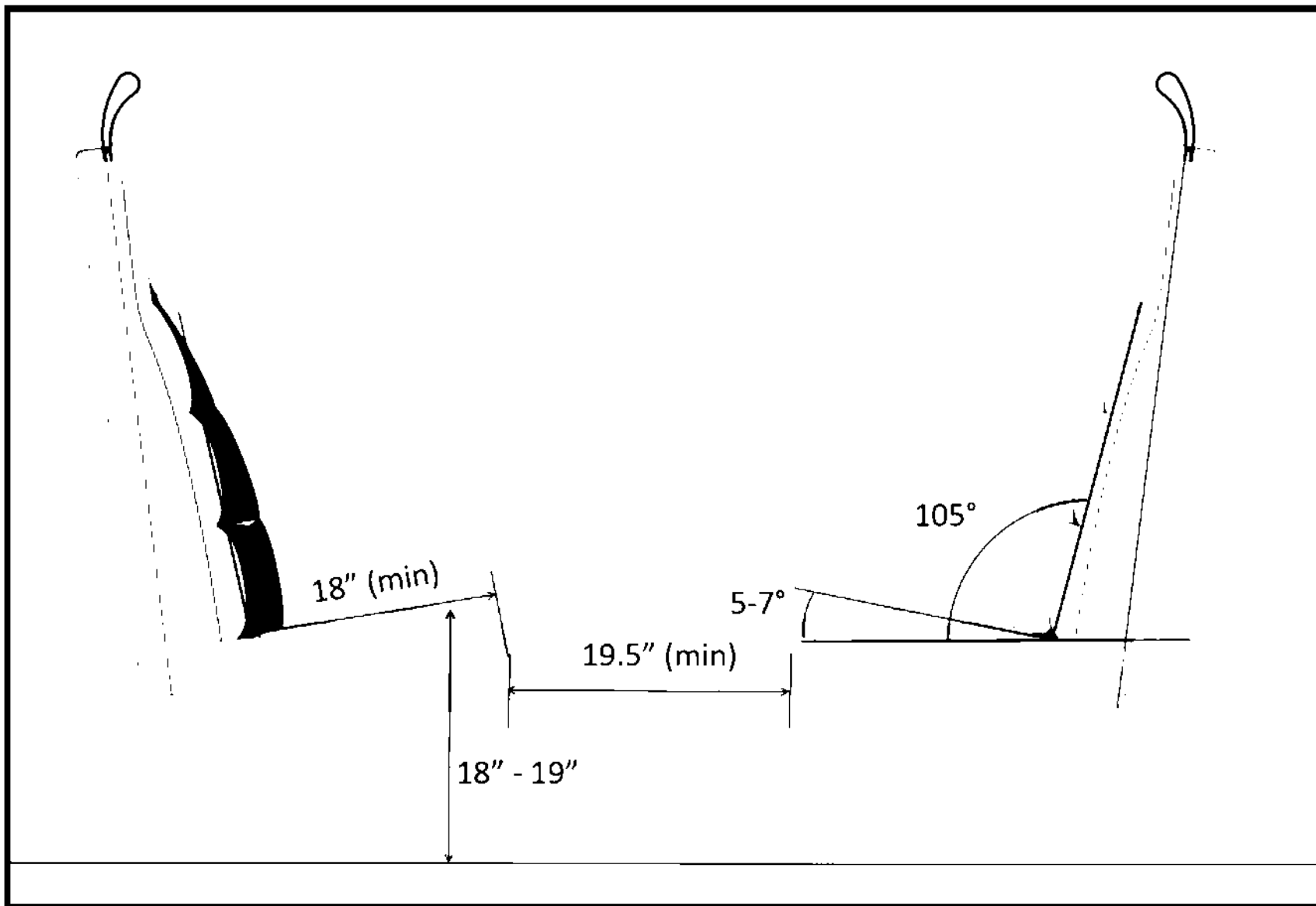

Figure 11-67: Roomette Seat Dimensions

CONFIDENTIAL — DO NOT DISTRIBUTE

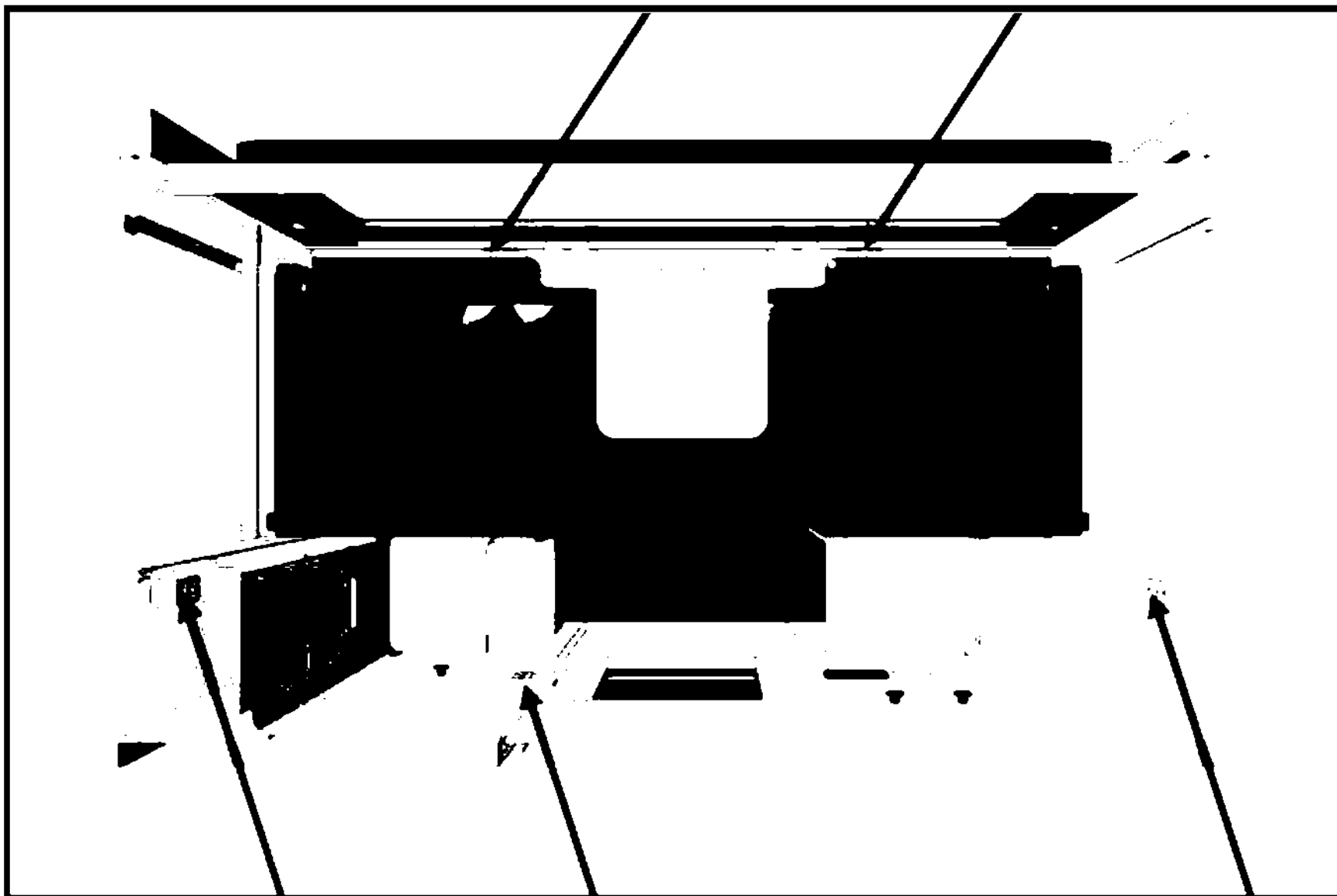

Figure 11-68: Roomette Outlet Locations

CONFIDENTIAL — DO NOT DISTRIBUTE

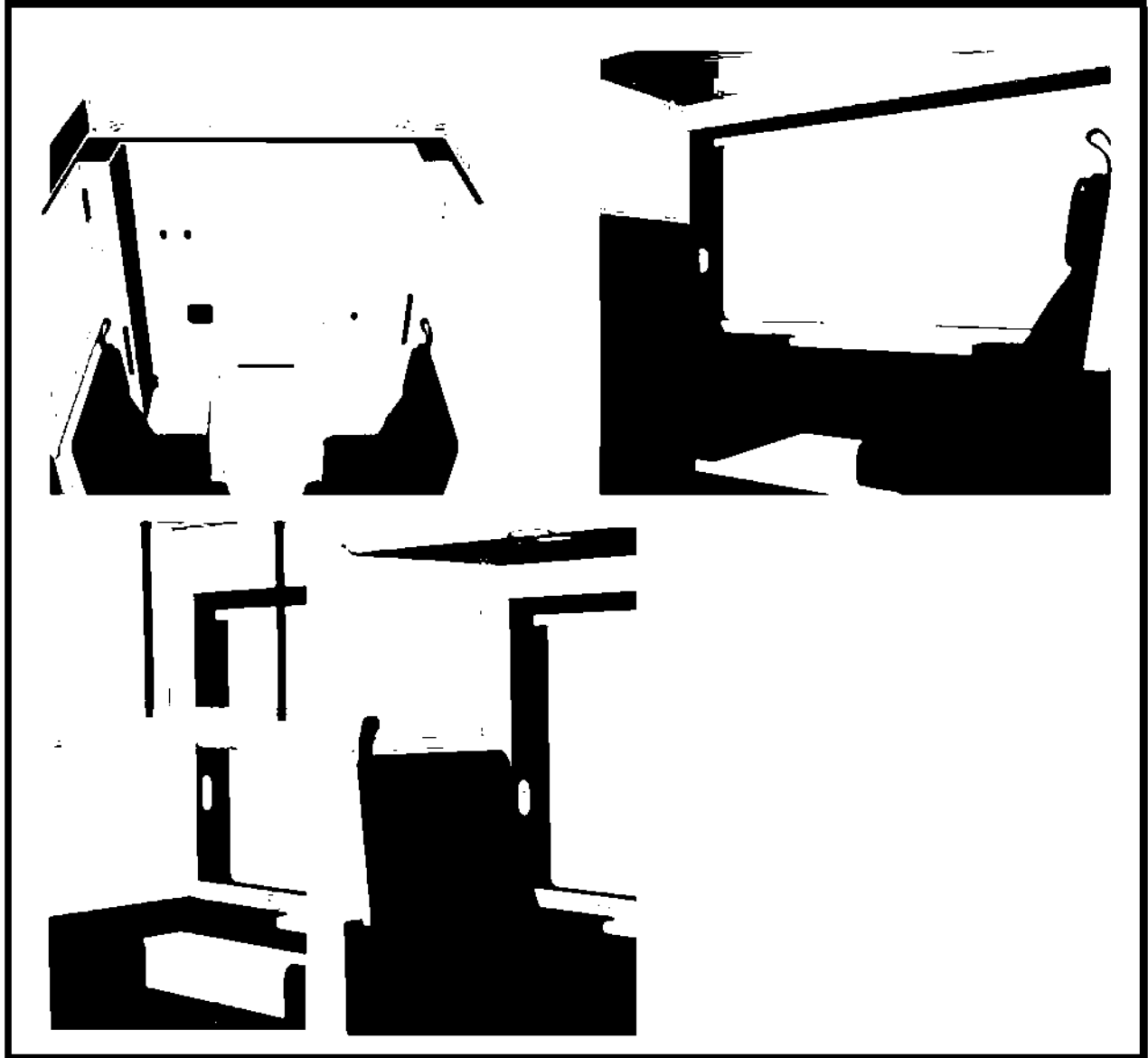

Figure 11-69: Roomette Wash Light Locations

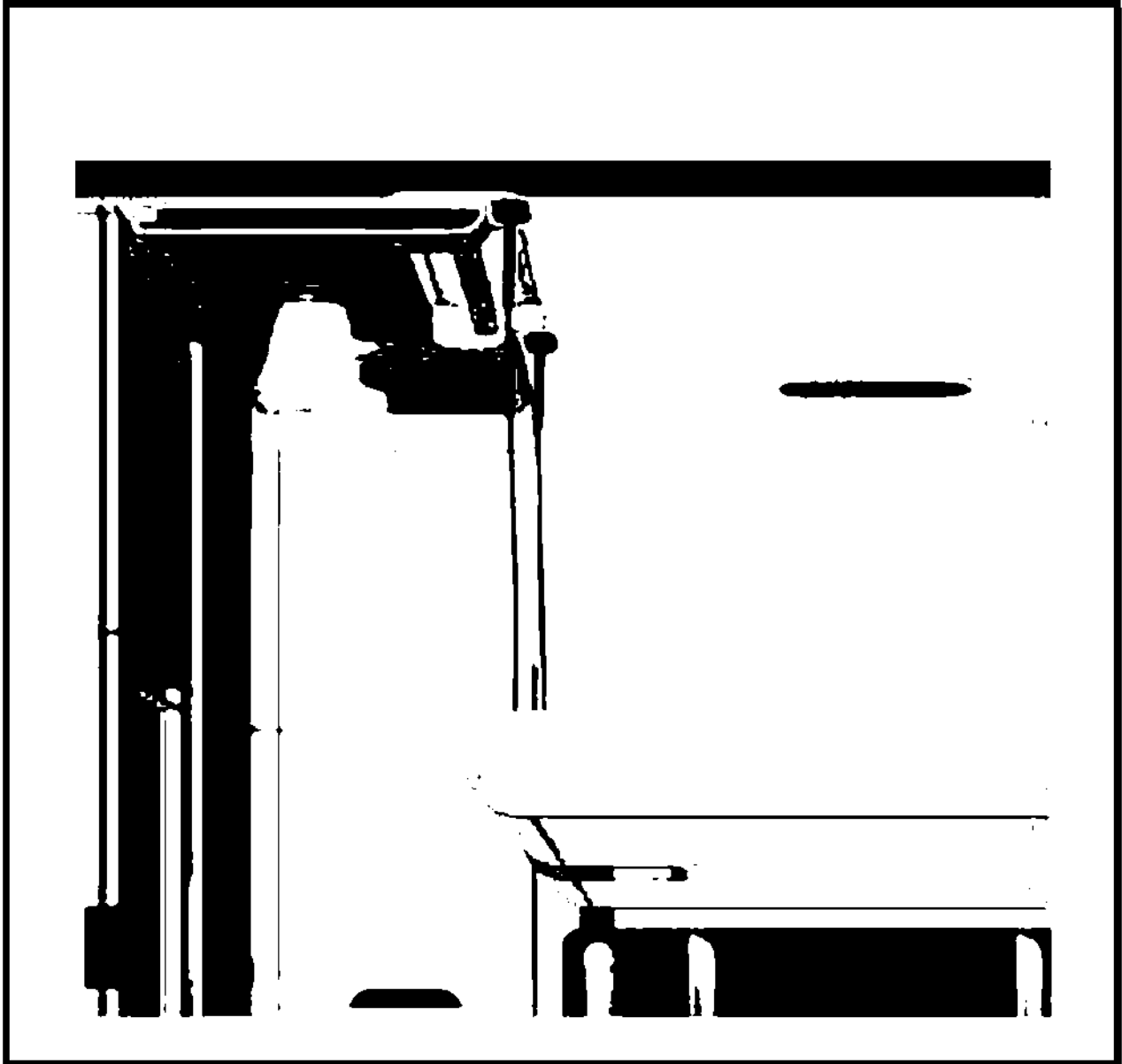

Figure 11-70: Roomette Spot Light Locations



Figure 11-71: Roomette Compartment Light Locations

CONFIDENTIAL — DO NOT DISTRIBUTE

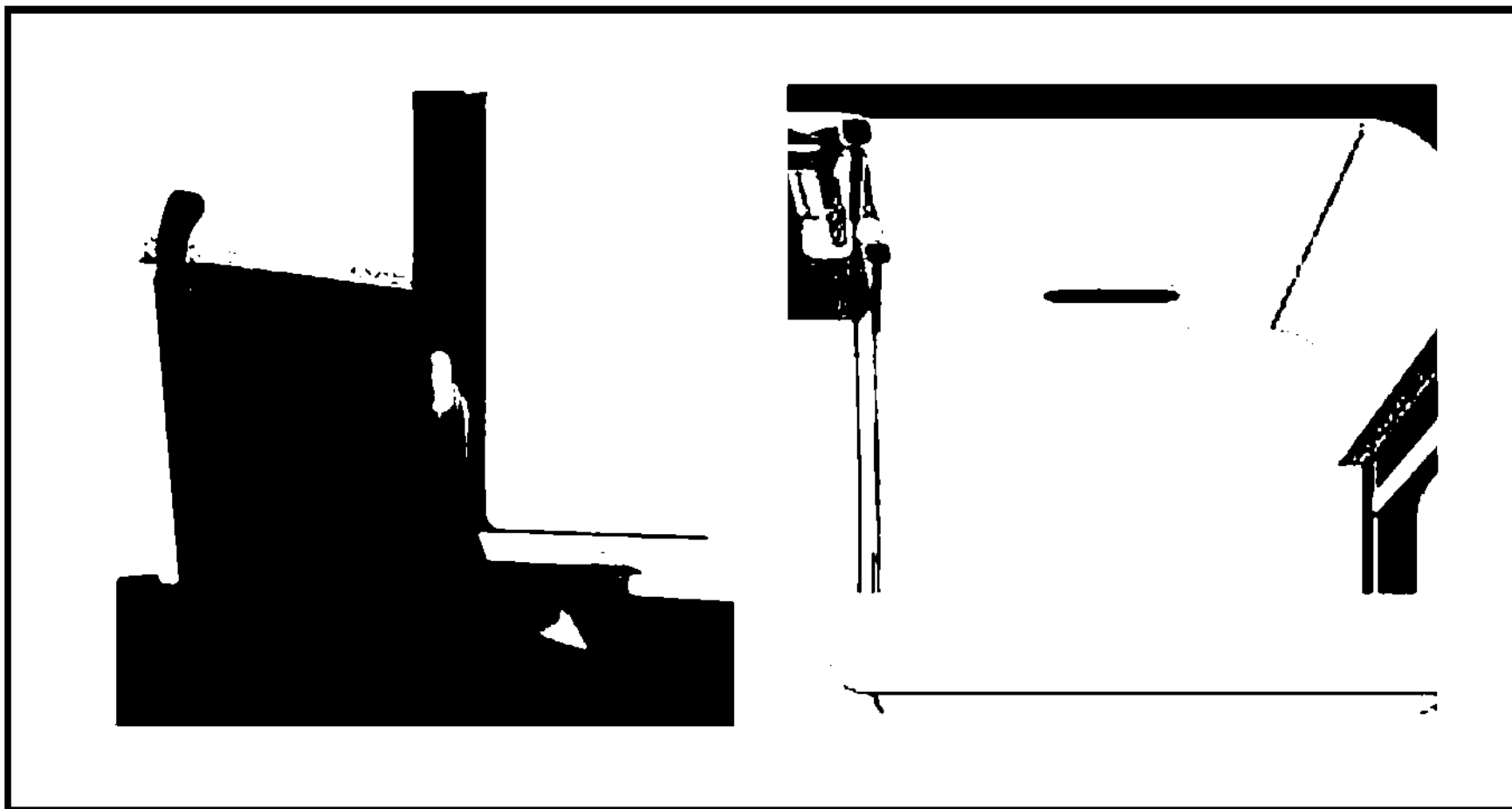

Figure 11-72: Roomette Reading Light Locations

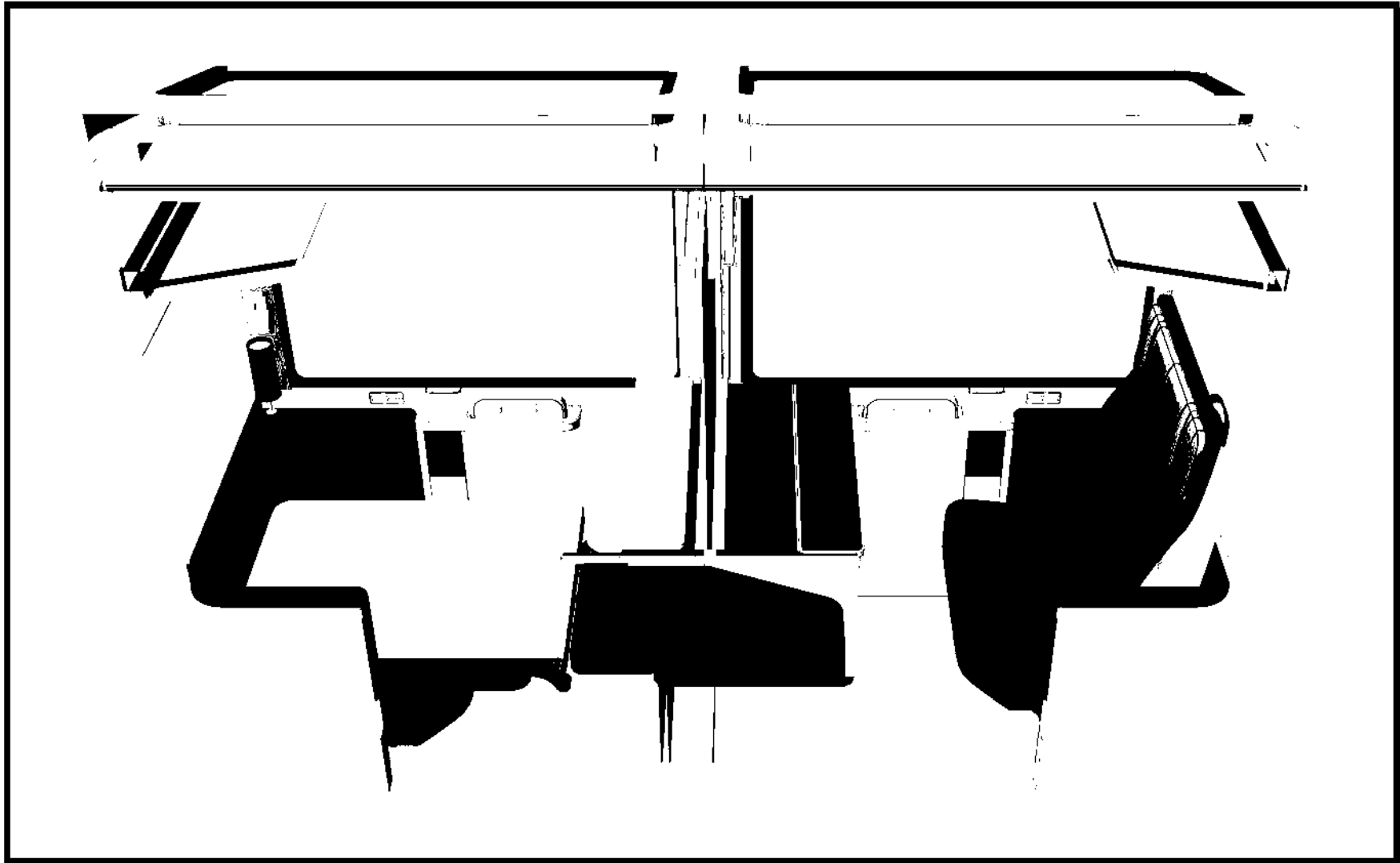

Figure 11-73: SoloSuite Cabin

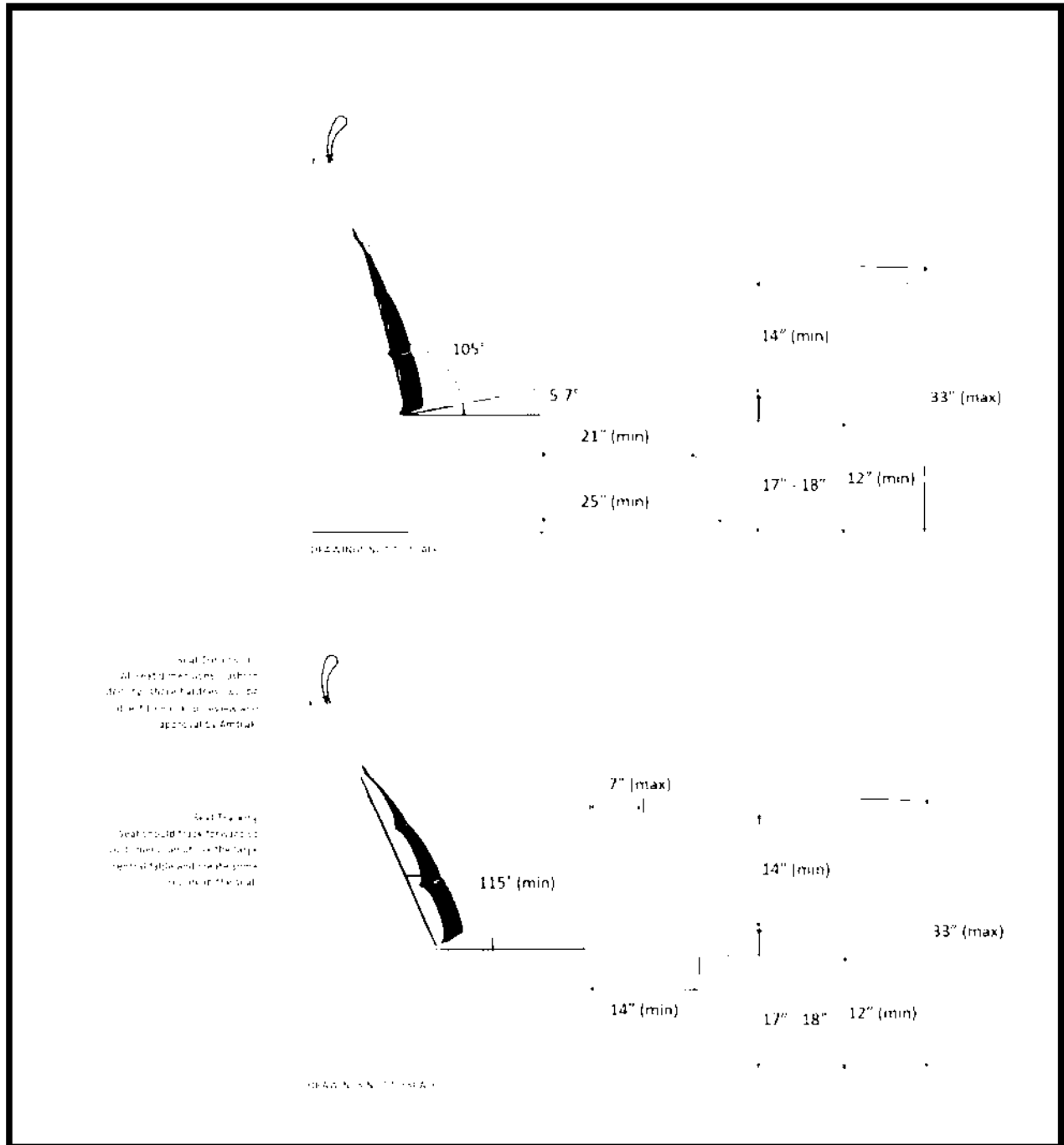

Figure 11-74: SoloSuite Seat Dimensions



Figure 11-75: SoloSuite Outlet Locations

CONFIDENTIAL — DO NOT DISTRIBUTE

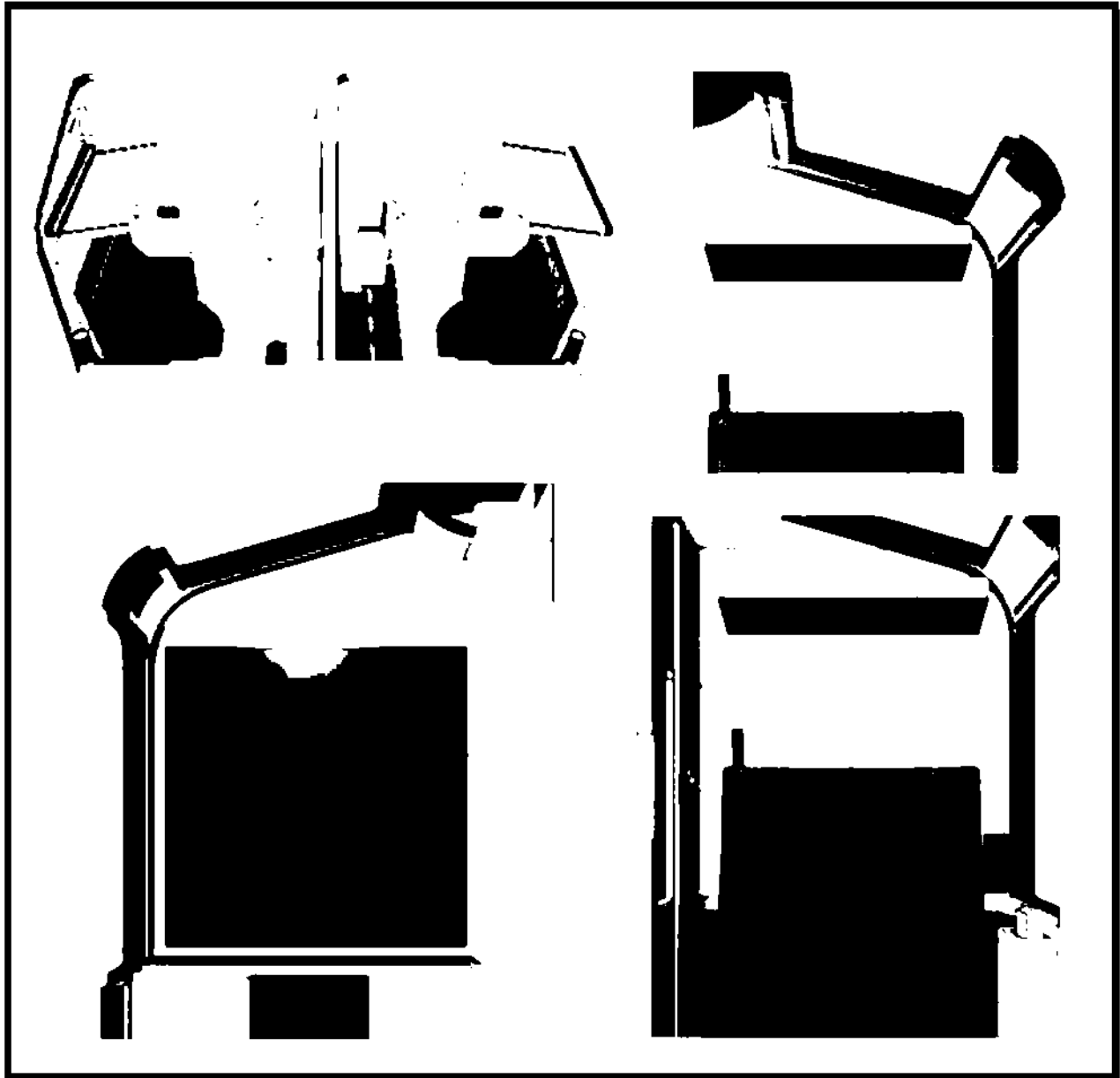

Figure 11-76: SoloSuite Wash Light Locations

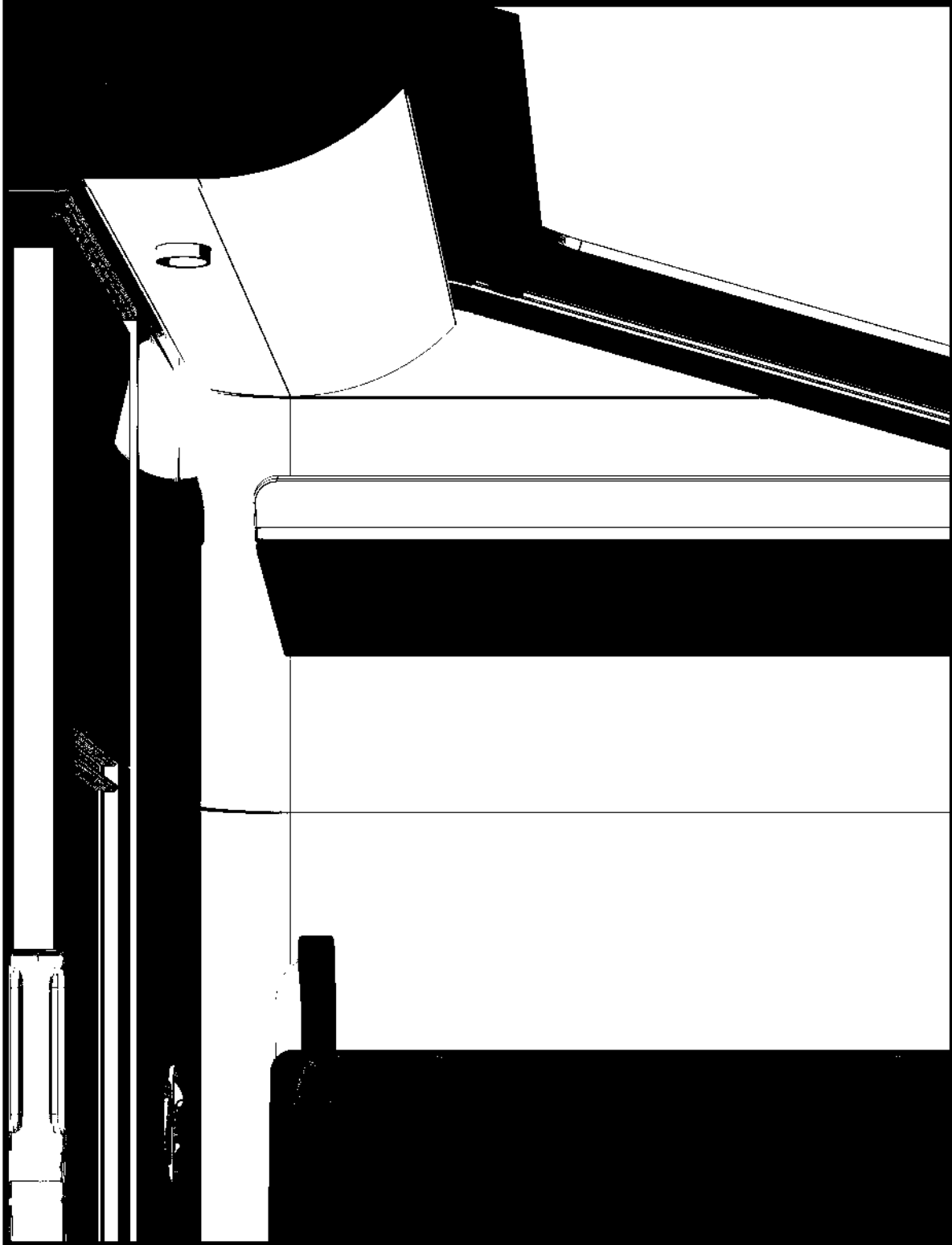

Figure 11-77: SoloSuite Spot Light Locations

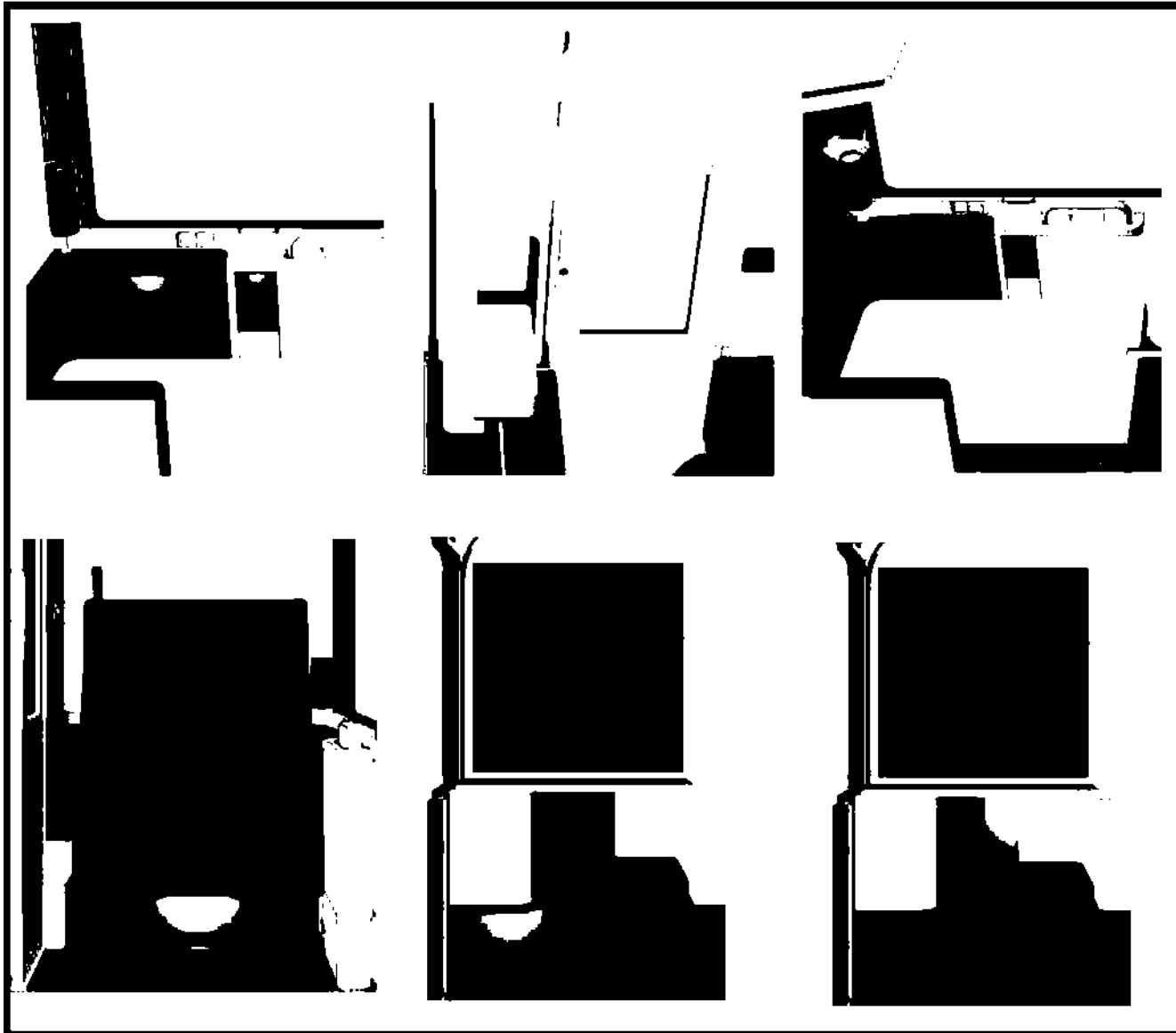

Figure 11-78: SoloSuite Compartment Light Locations

CONFIDENTIAL — DO NOT DISTRIBUTE

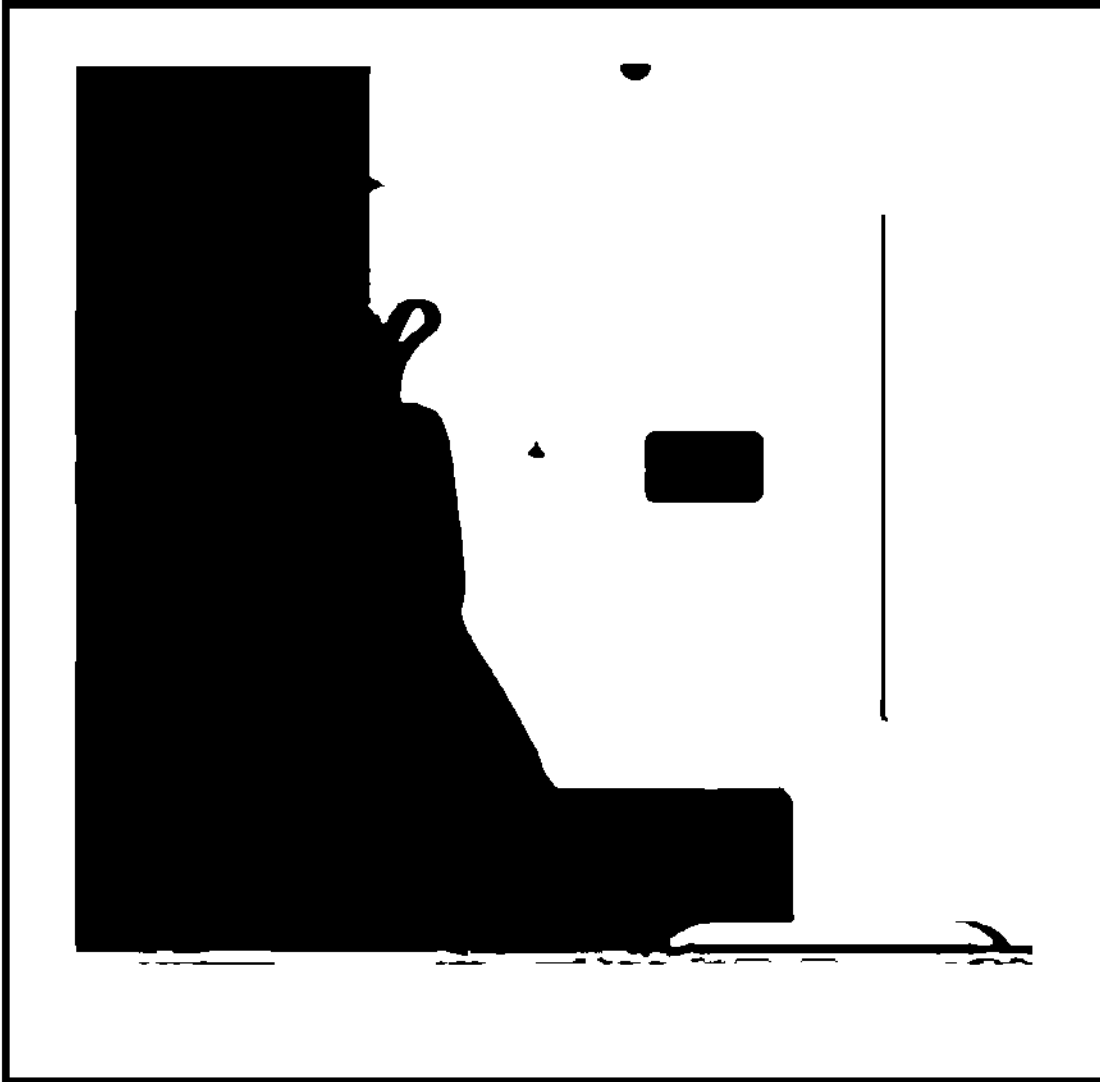

Figure 11-79: SoloSuite Reading Light Locations

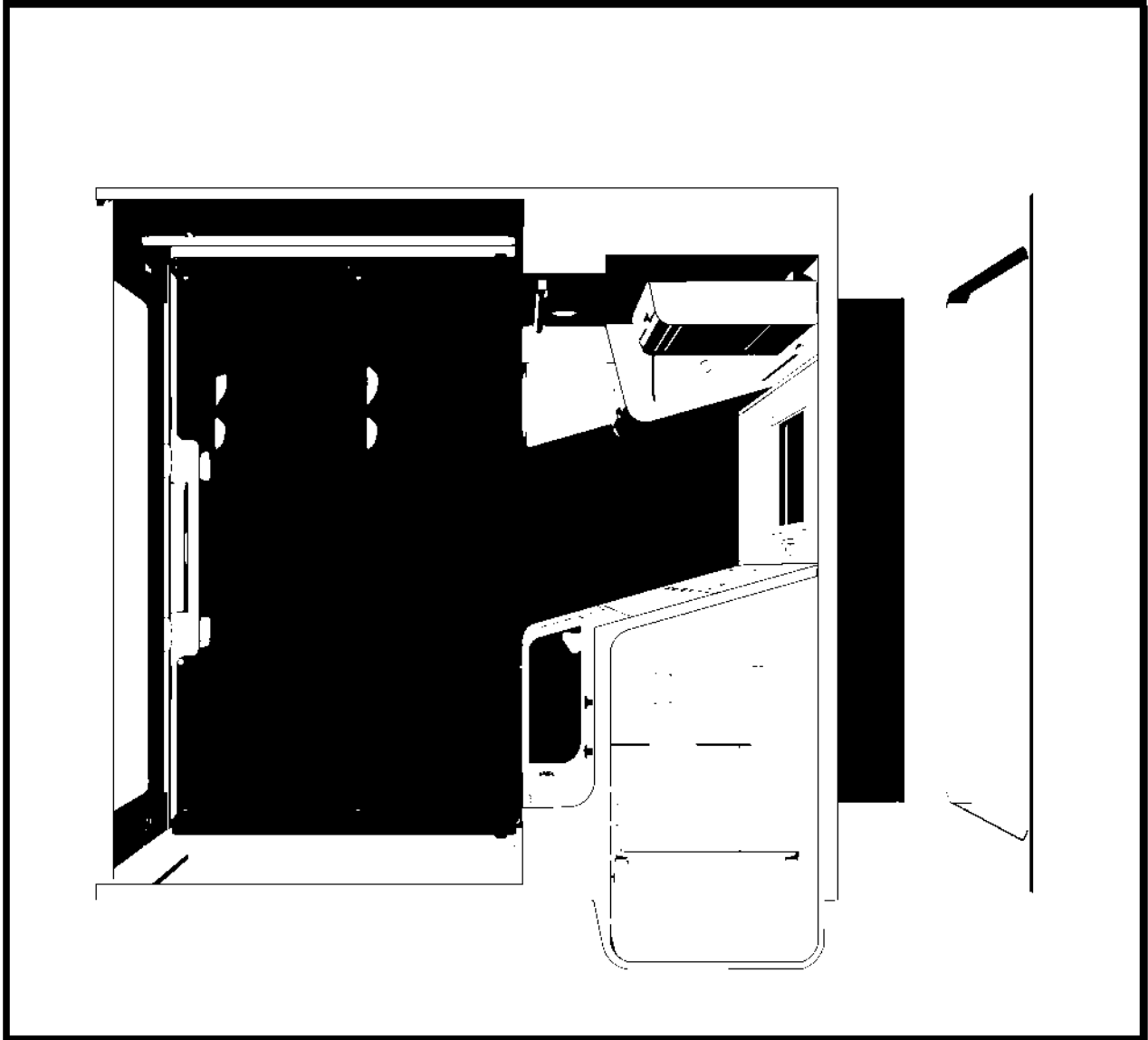

Figure 11-80: Club Bedroom Cabin

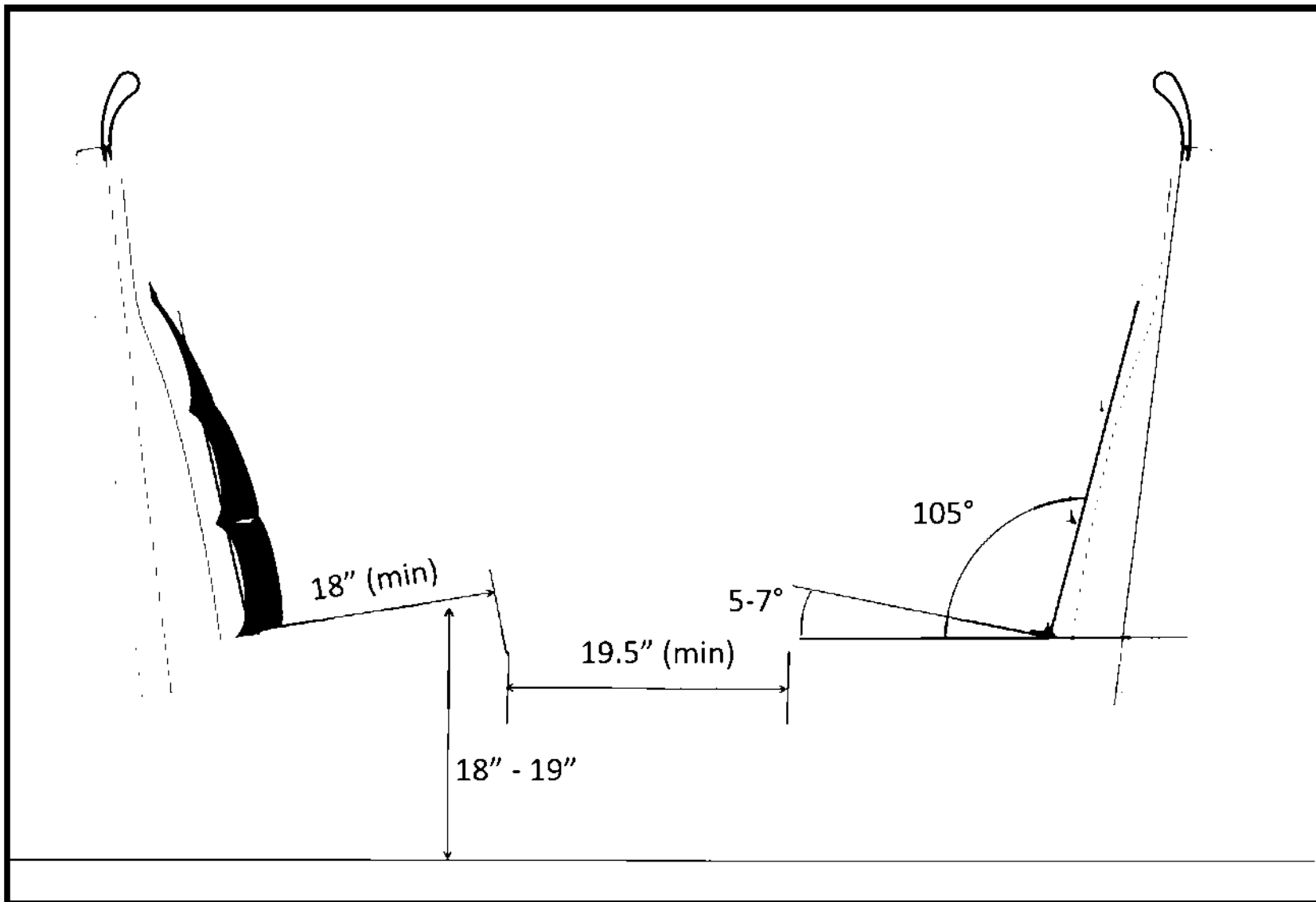

Figure 11-81: Club Bedroom Seat Dimensions

CONFIDENTIAL — DO NOT DISTRIBUTE

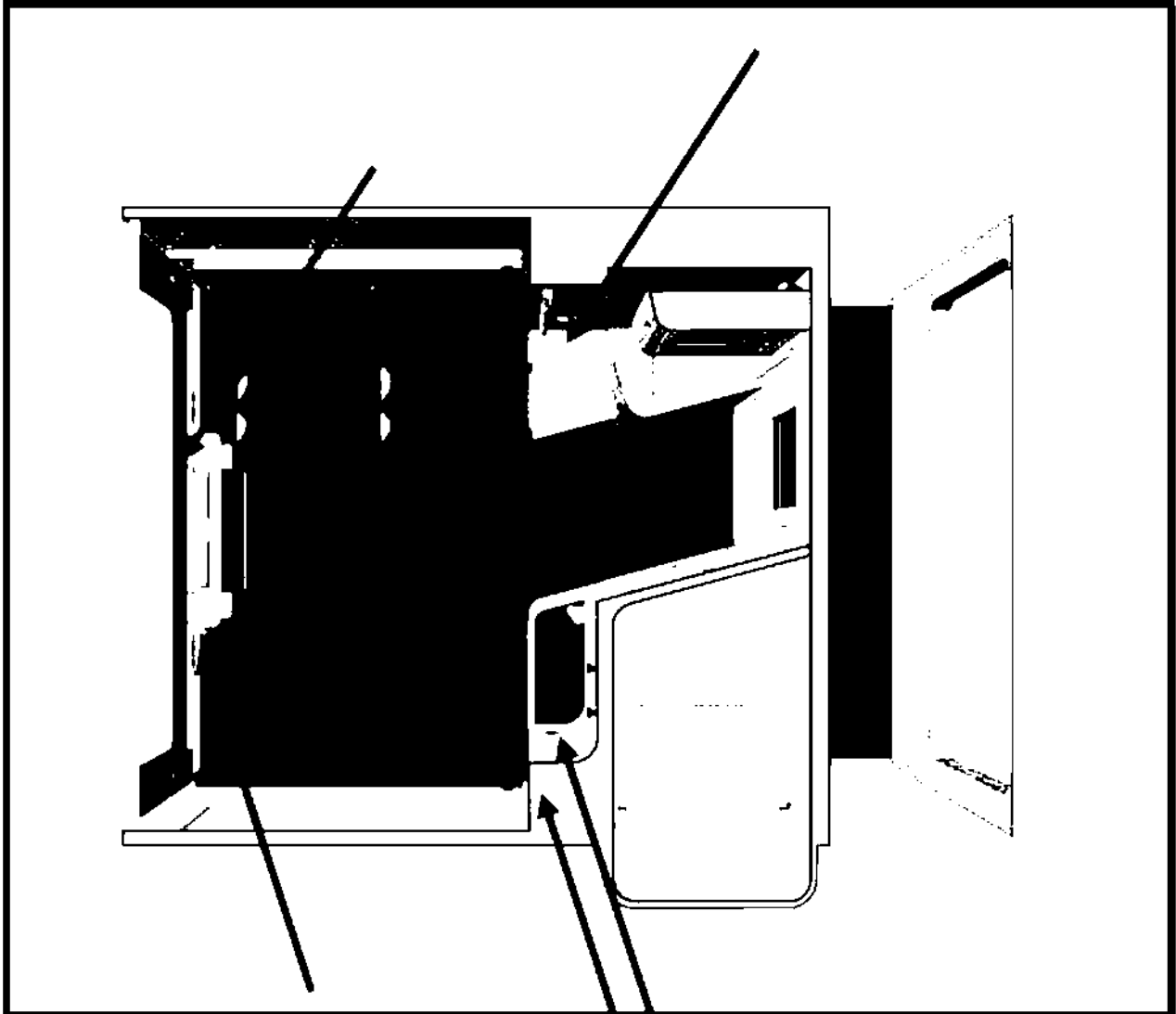

Figure 11-82: Club Bedroom Outlet Locations

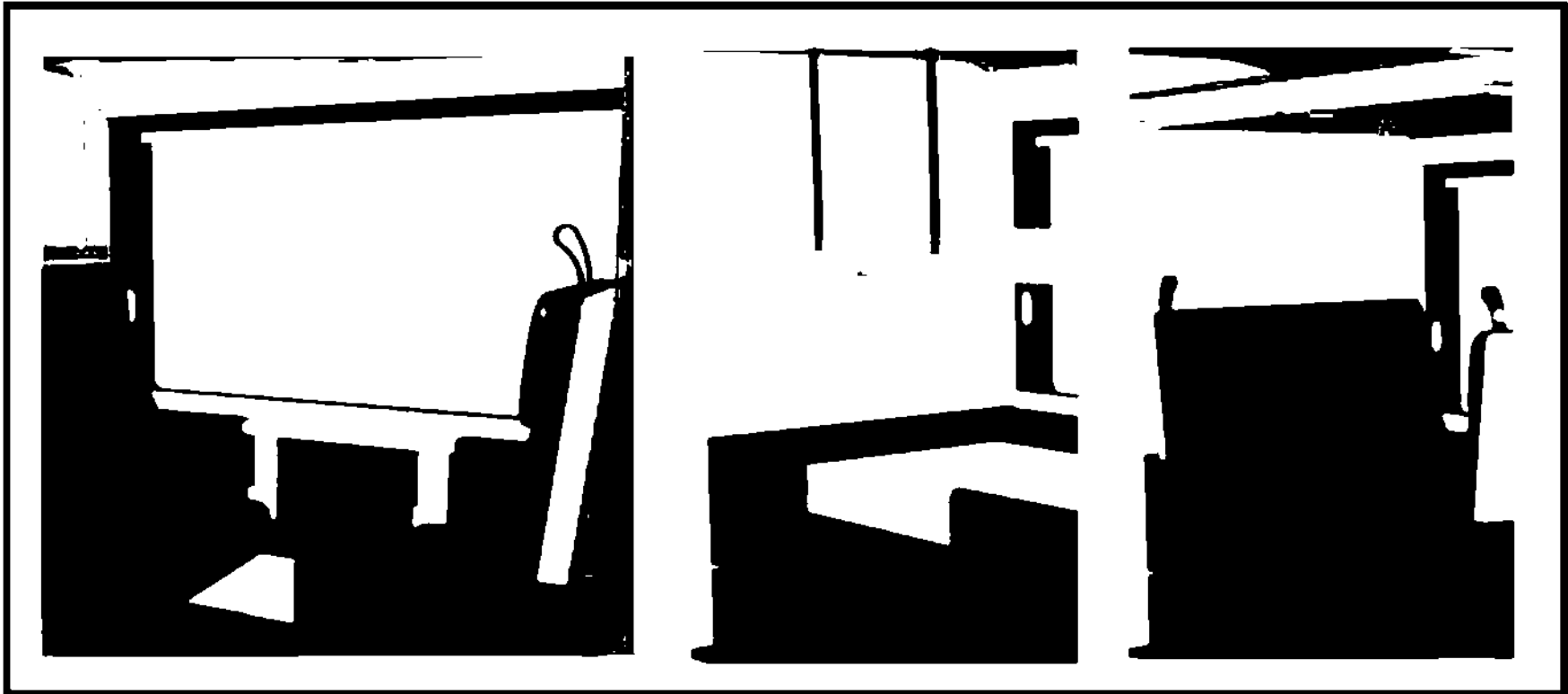

Figure 11-83: Club Bedroom Wash Light Locations



Figure 11-84: Club Bedroom Spot Light Locations

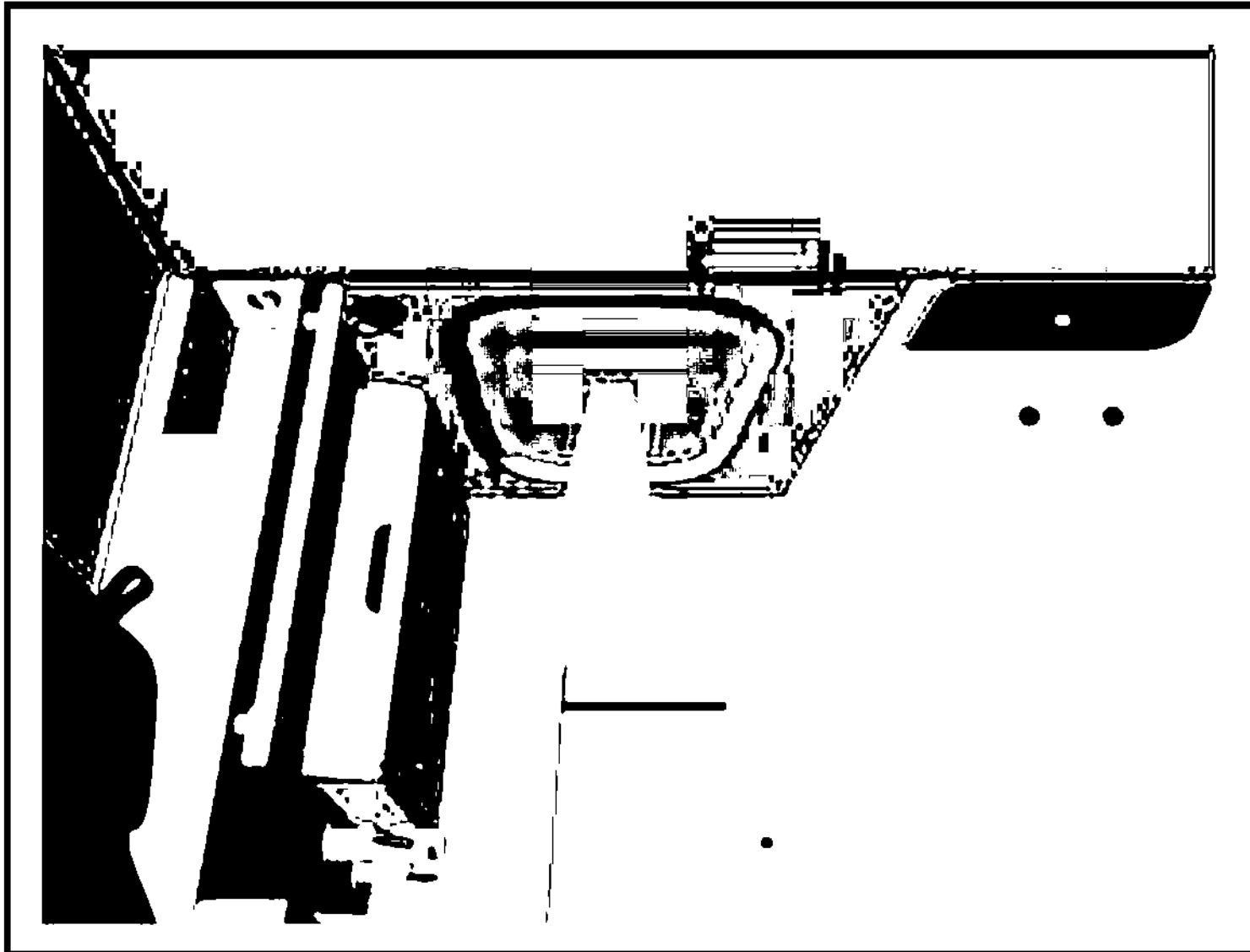

Figure 11-85: Club Bedroom Lobby Light Locations

CONFIDENTIAL — DO NOT DISTRIBUTE

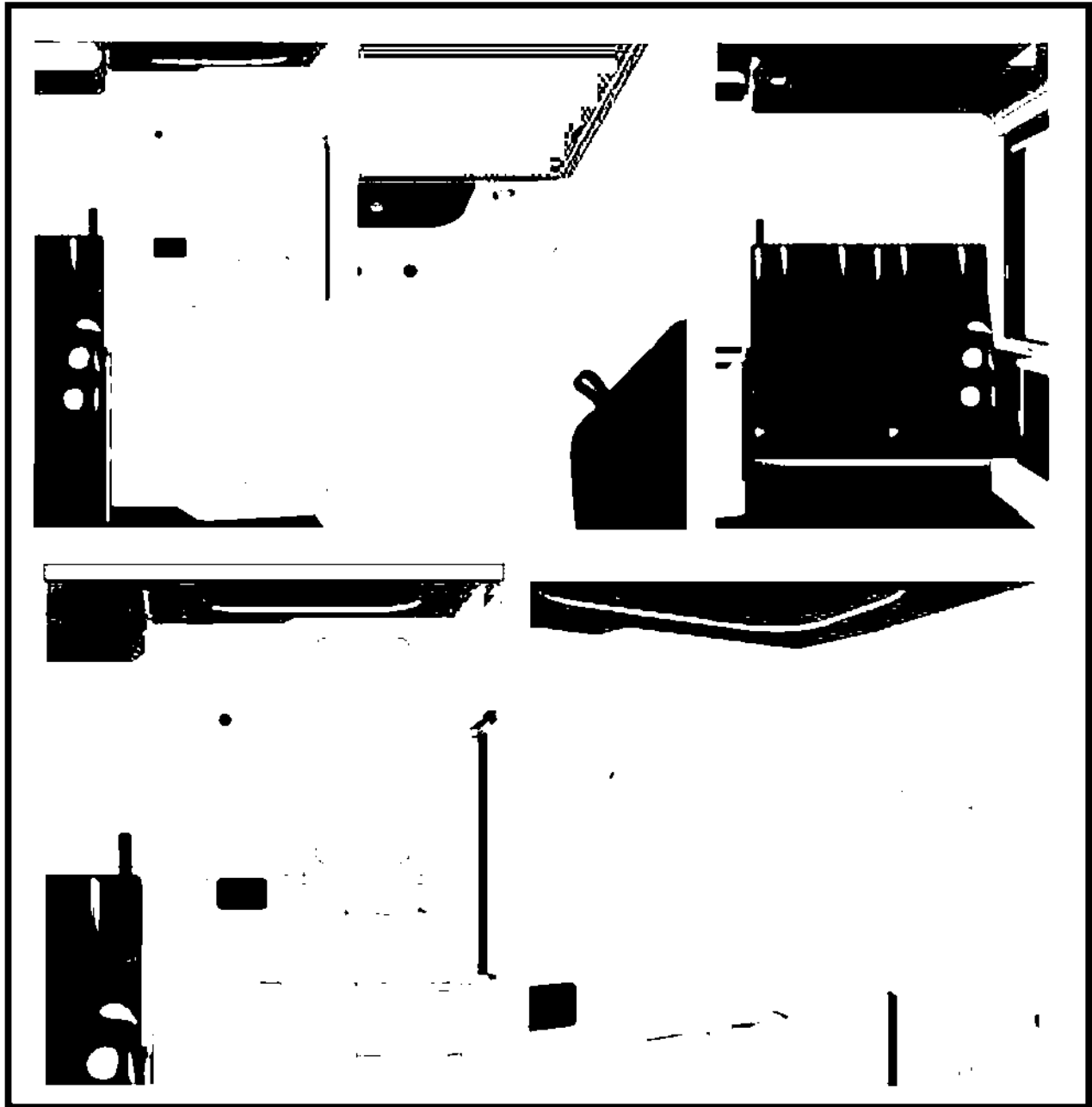

Figure 11-86: Club Bedroom Light Locations

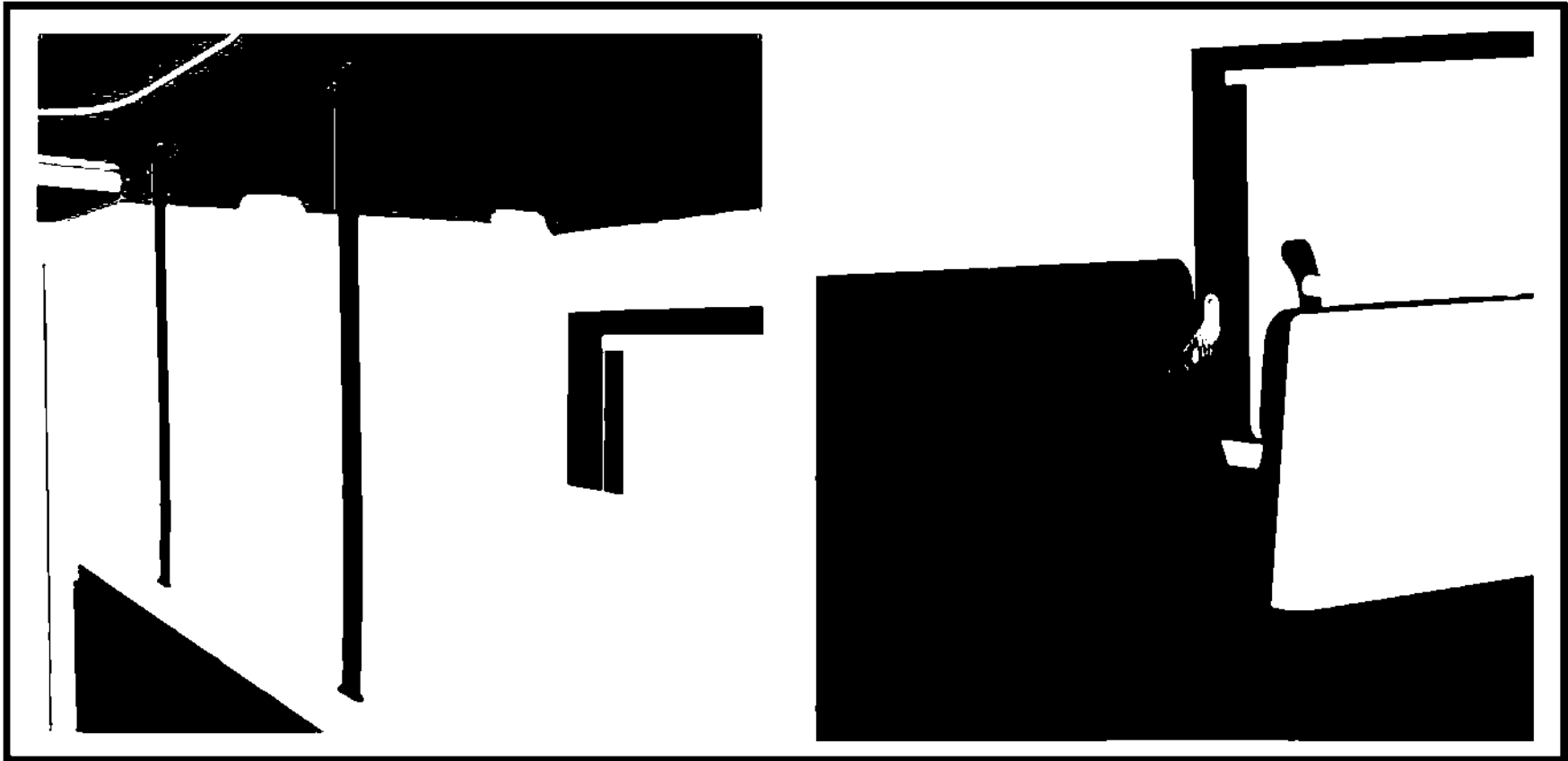

Figure 11-87: Club Bedroom Reading Light Locations



Figure 11-88: Club Bedroom Restroom Light Locations

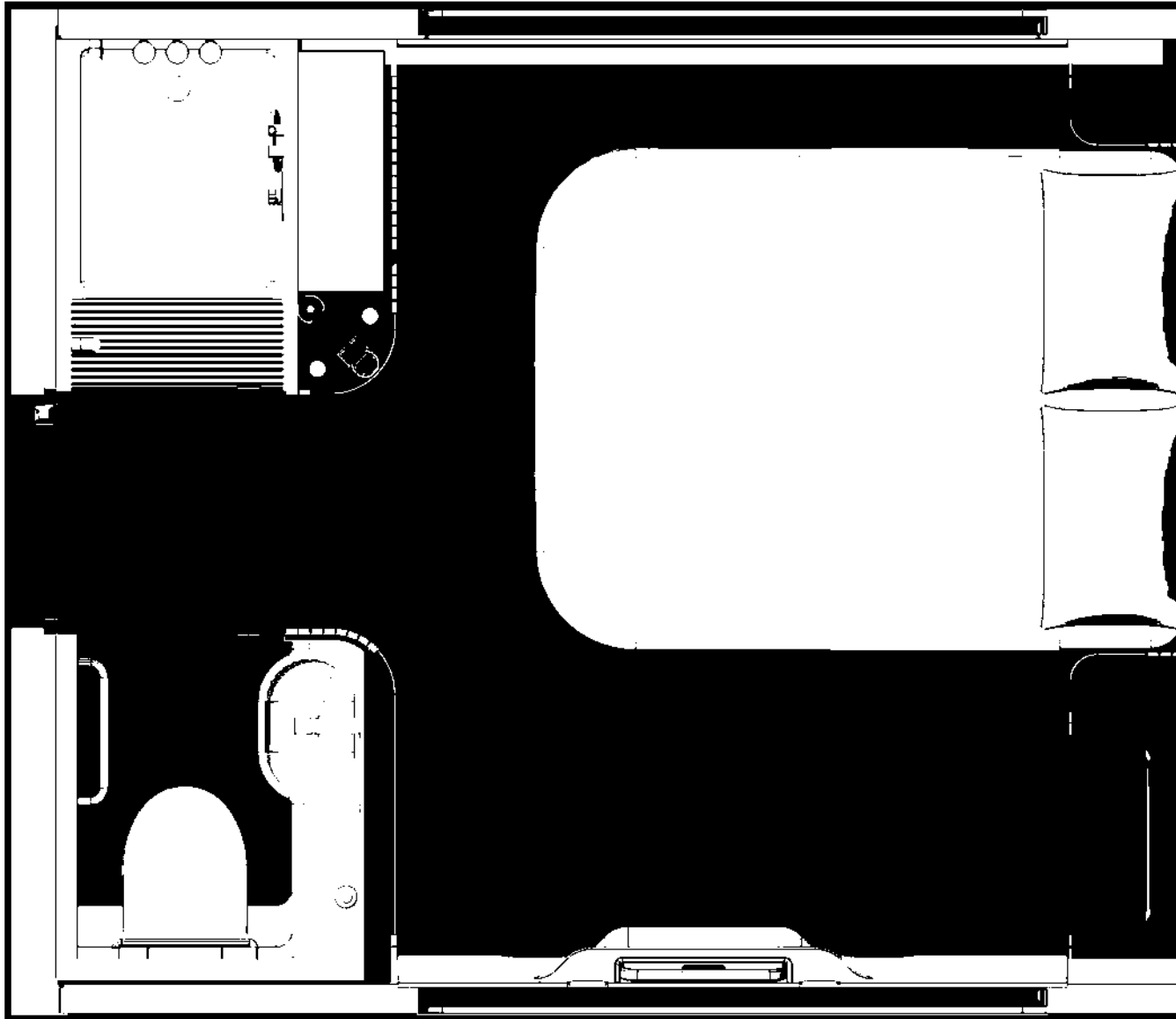

Figure 11-89: Premium Bedroom Cabin

CONFIDENTIAL — DO NOT DISTRIBUTE

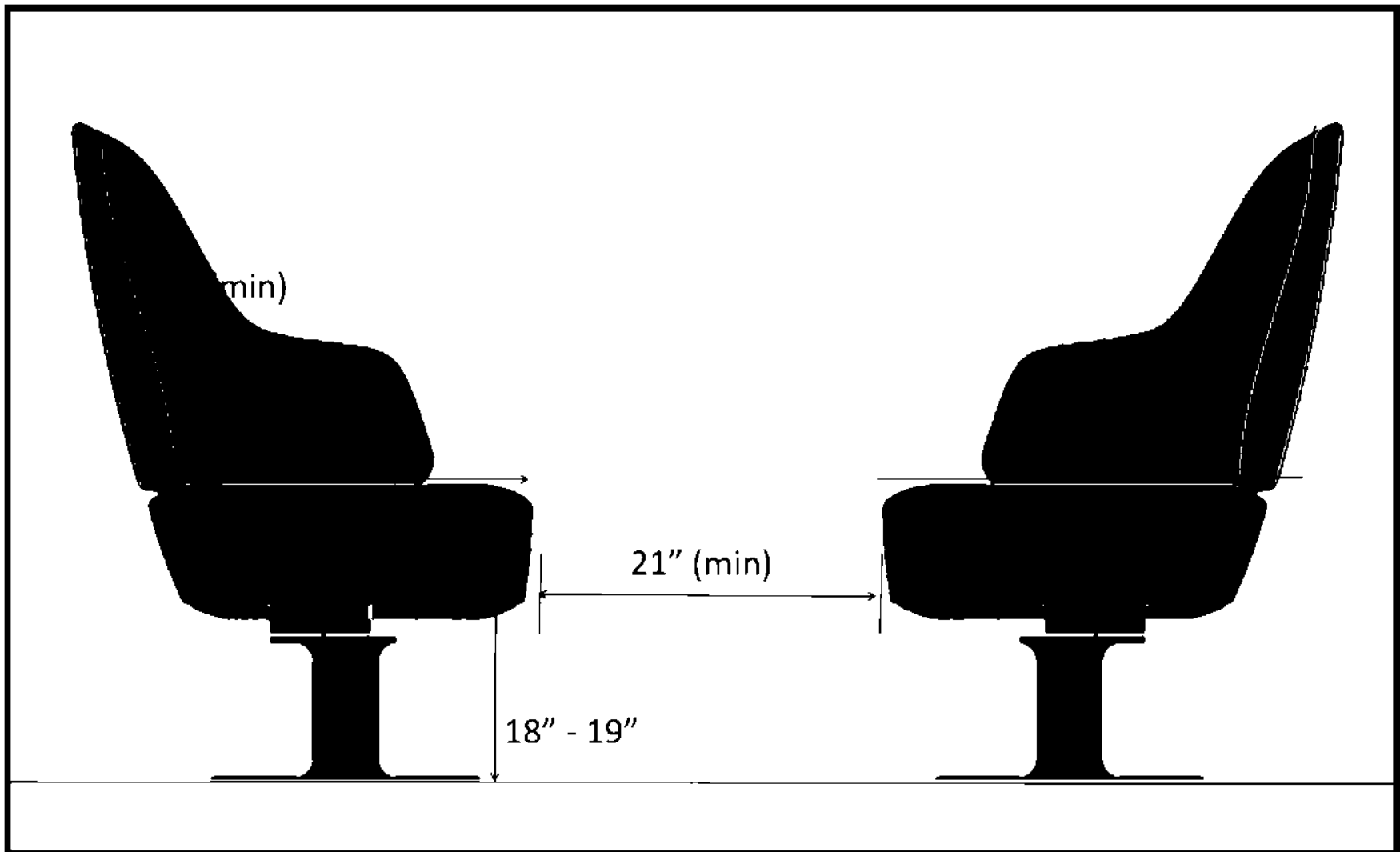

Figure 11-90: Premium Bedroom Seat Dimensions

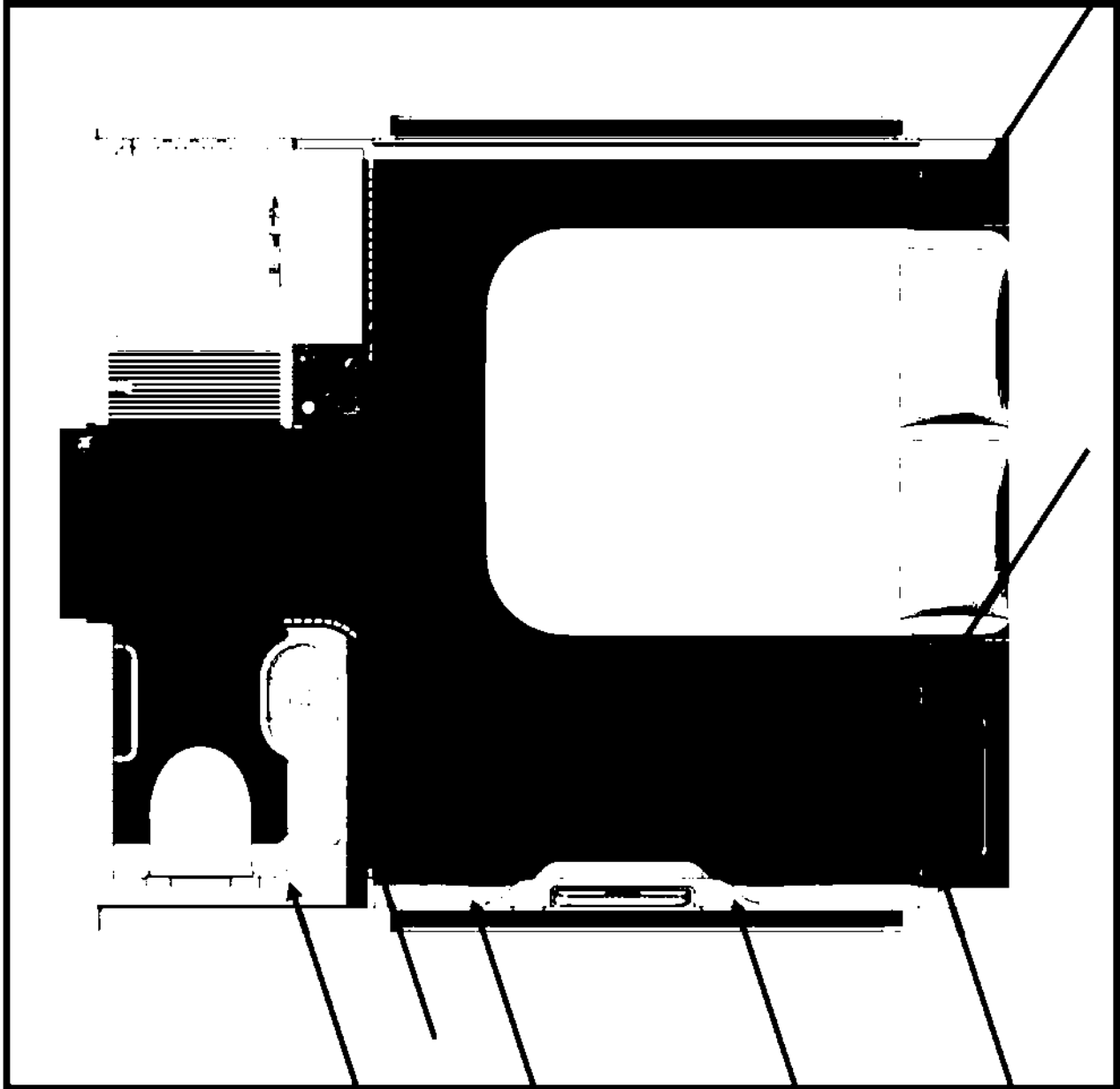

Figure 11-91: Premium Bedroom Outlet Locations

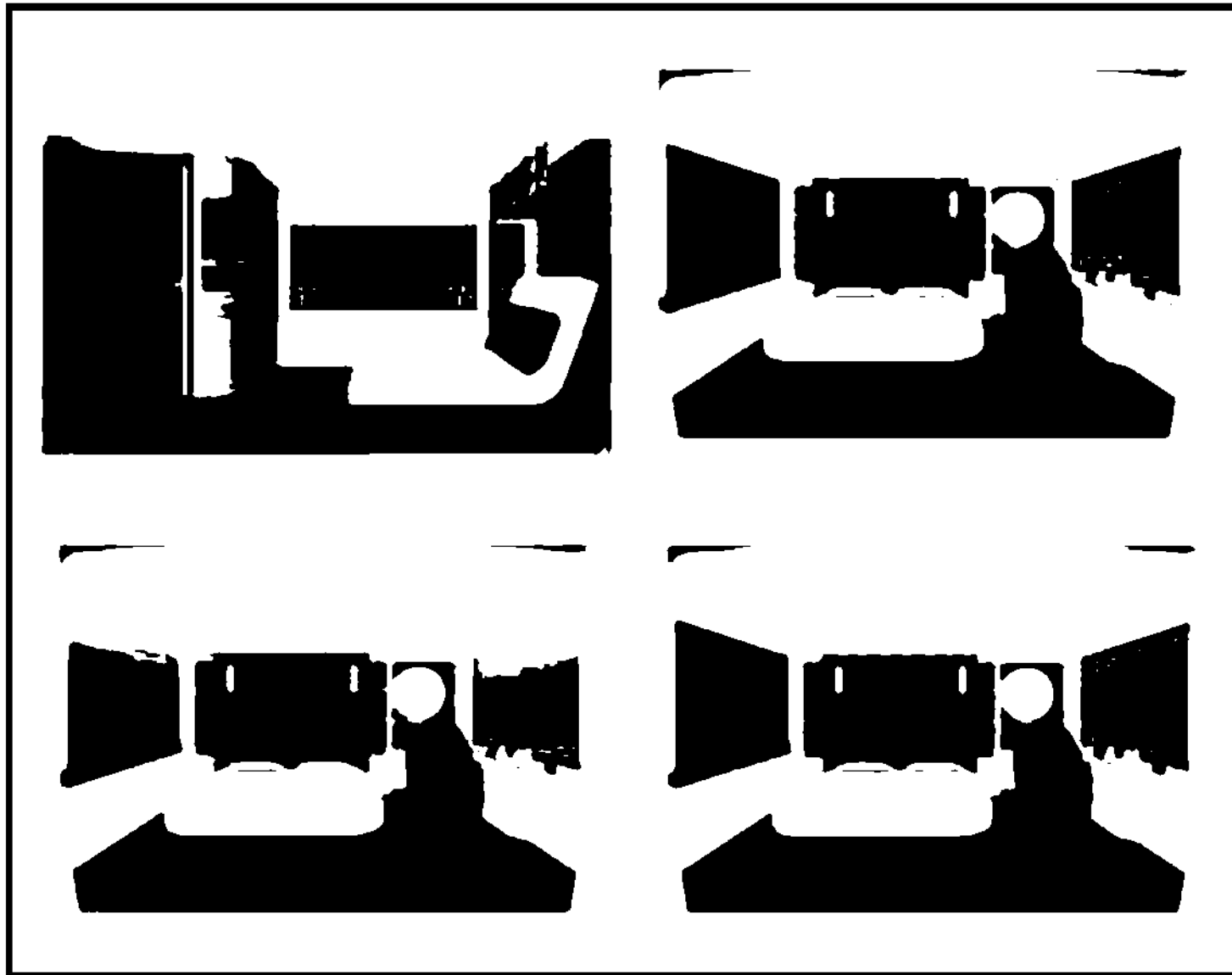

Figure 11-92: Premium Bedroom Wash Light Locations

CONFIDENTIAL — DO NOT DISTRIBUTE

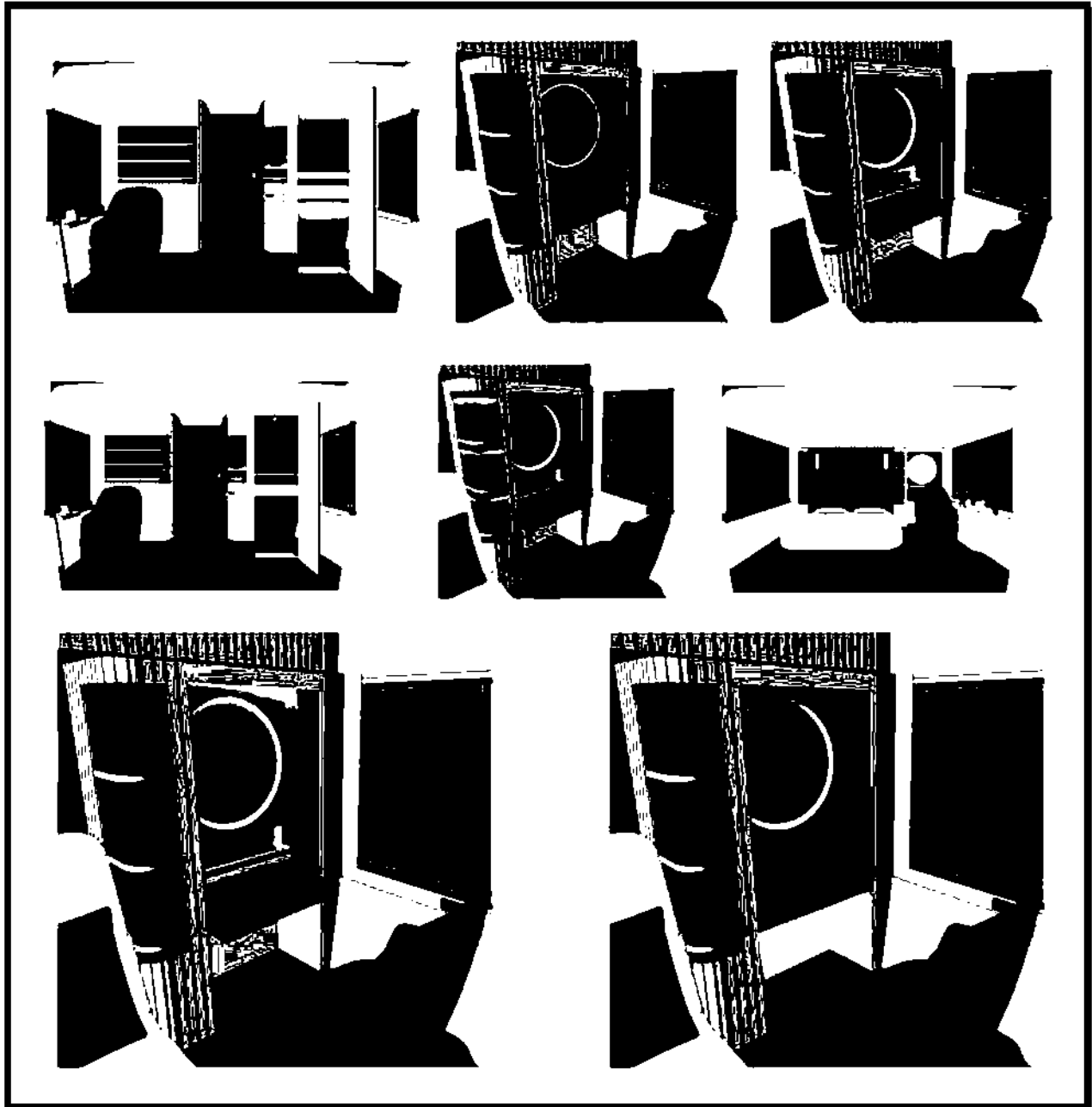

Figure 11-93: Premium Bedroom Light Locations



Figure 11-94: Premium Bedroom Reading Light Locations

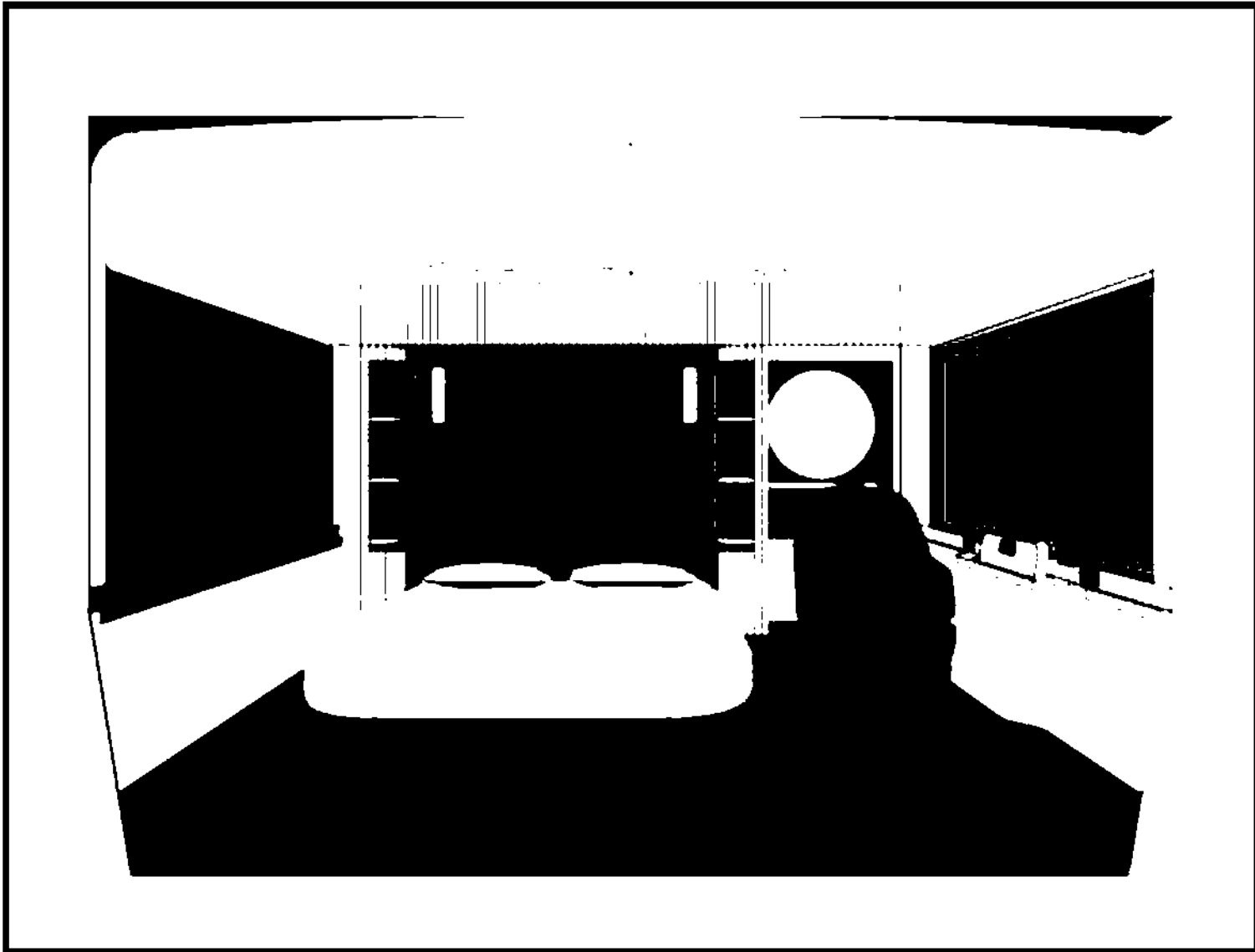

Figure 11-95: Premium Bedroom Ceiling Pool Light Locations

CONFIDENTIAL — DO NOT DISTRIBUTE

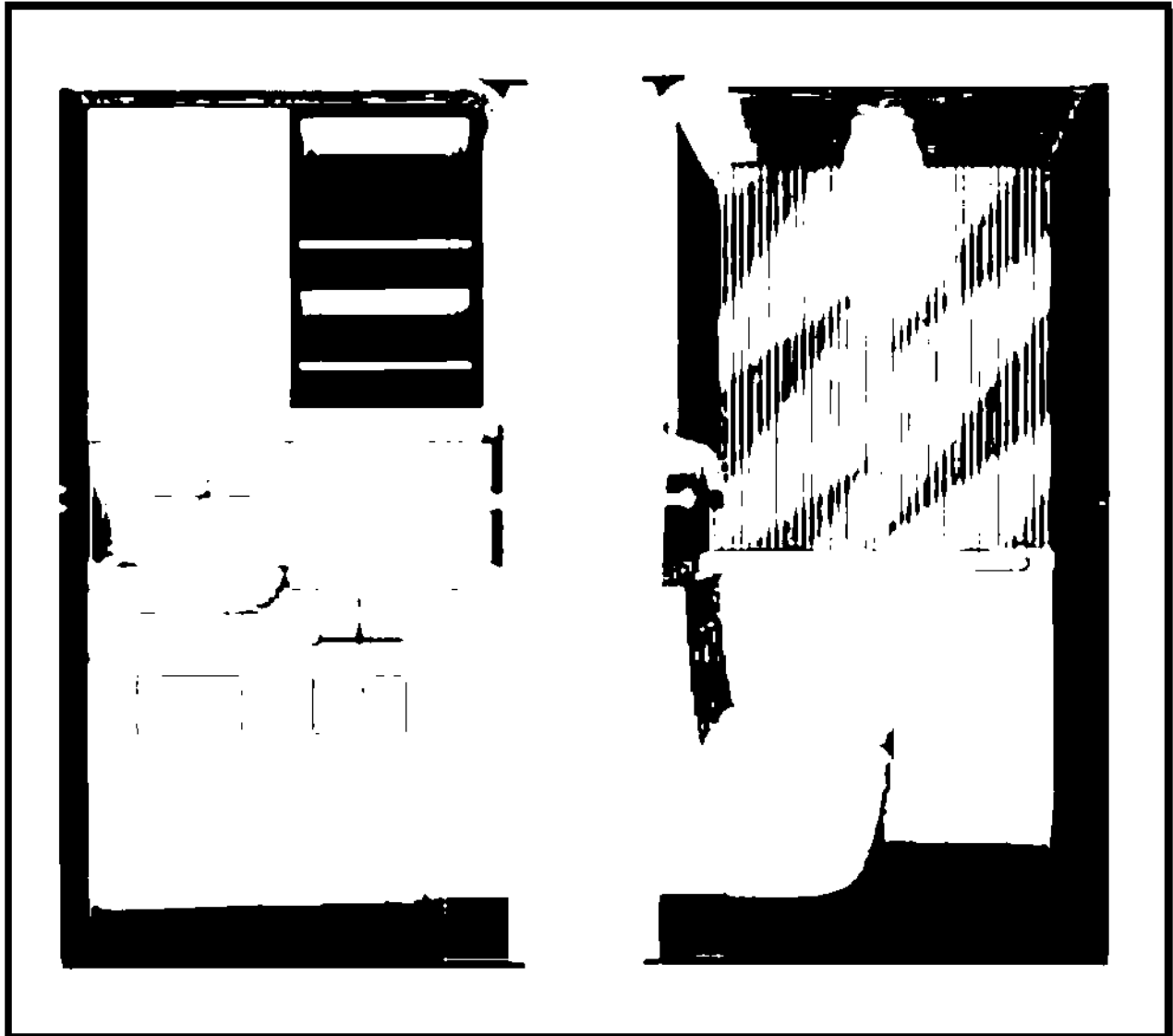

Figure 11-96: Premium Bedroom Restroom Light Locations

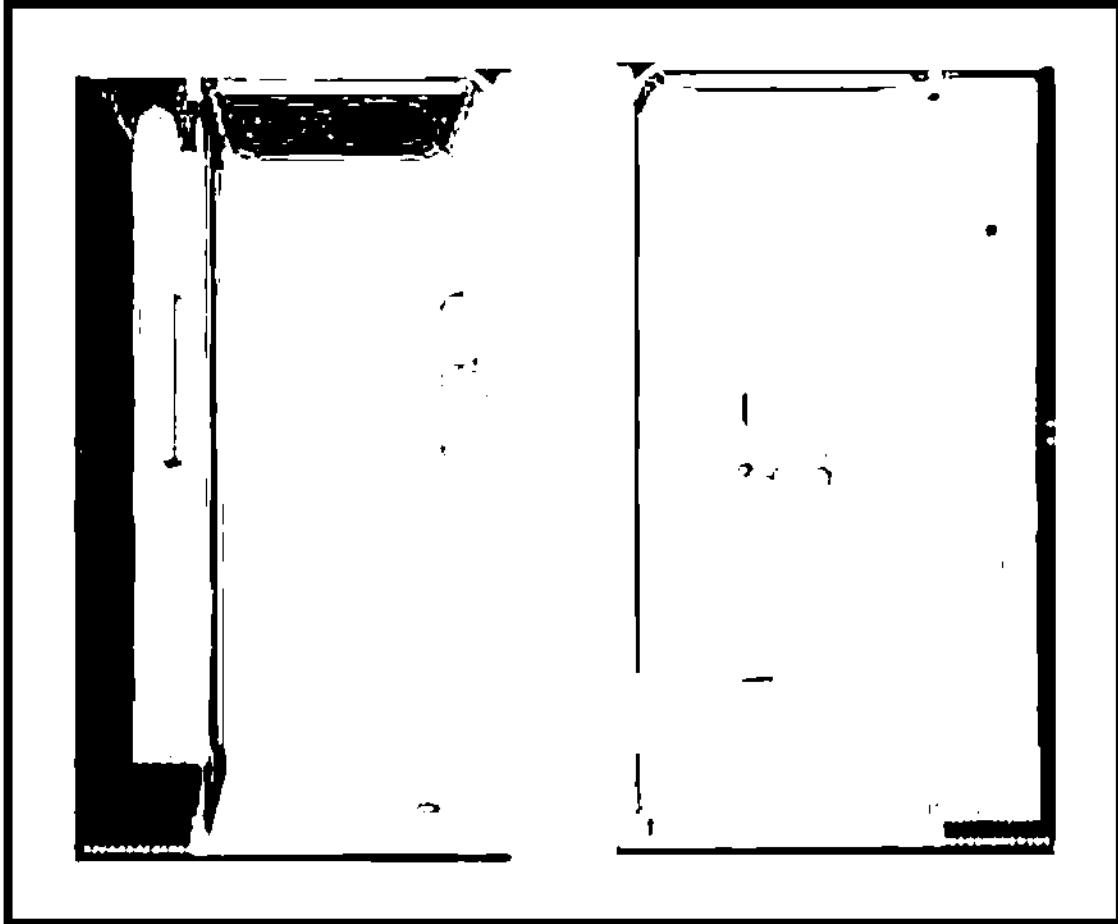

Figure 11-97: Premium Bedroom Shower Light Locations

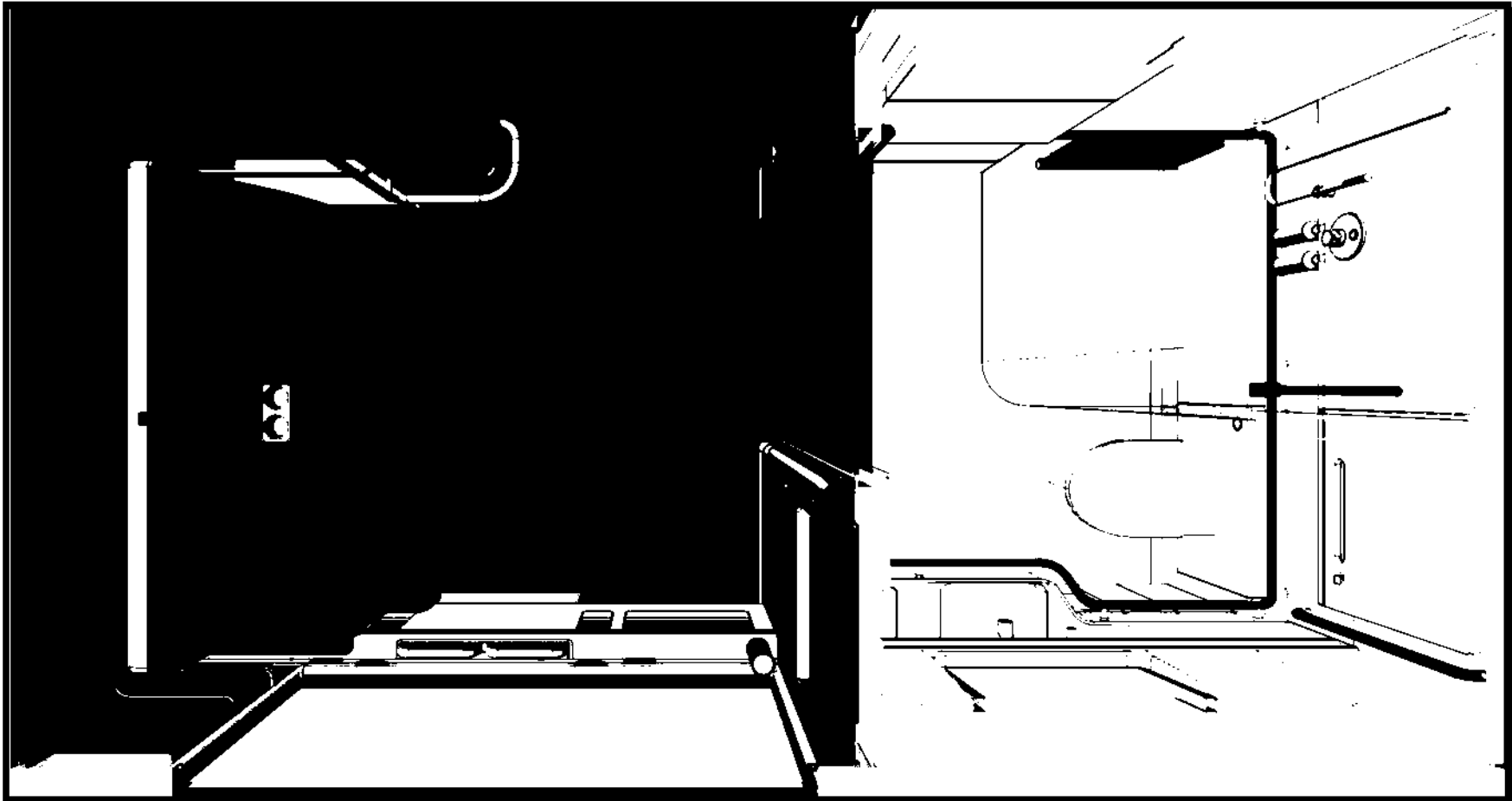

Figure 11-98: Accessible Twin Cabin

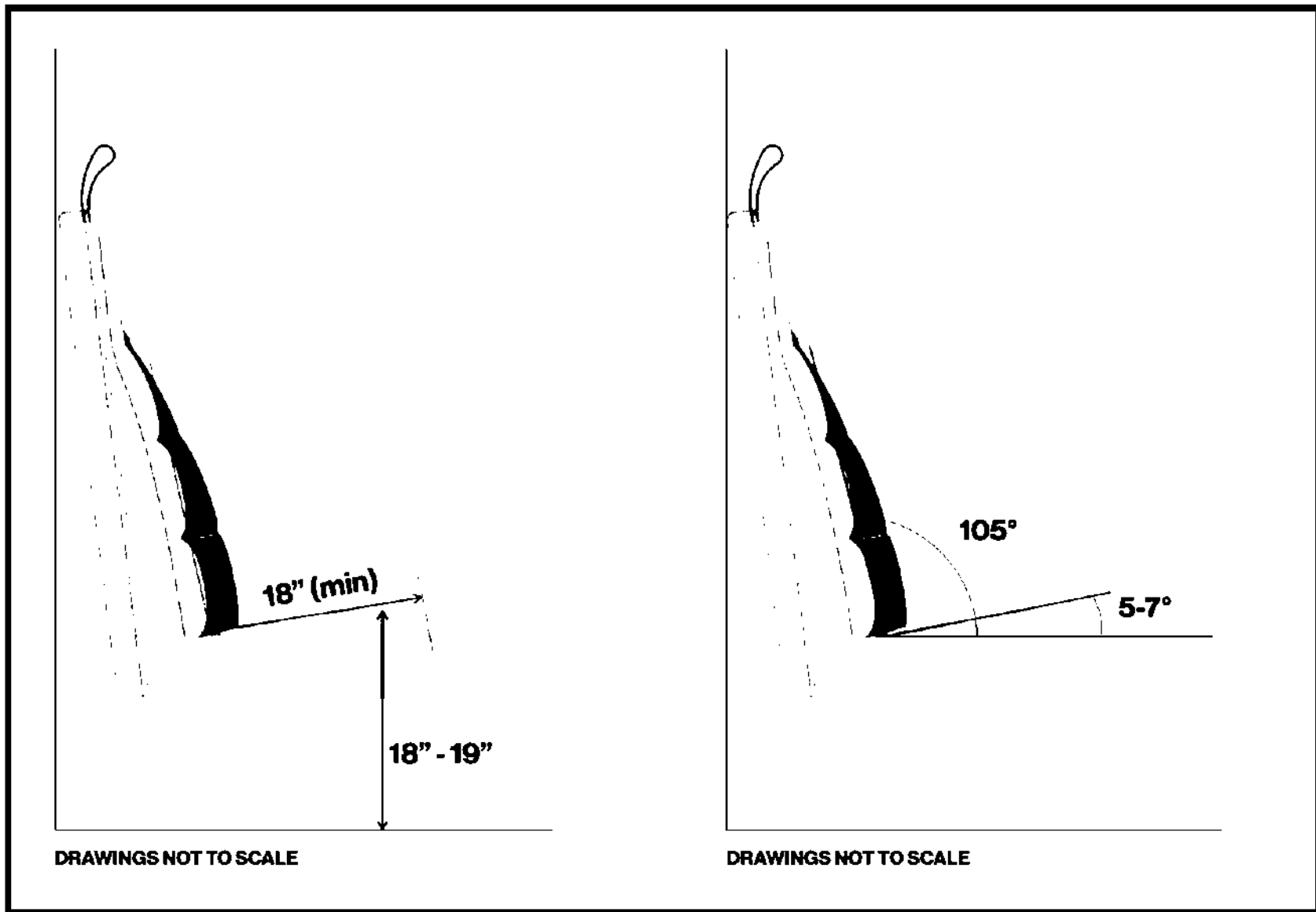

Figure 11-99: Accessible Twin Seat Dimensions

CONFIDENTIAL — DO NOT DISTRIBUTE

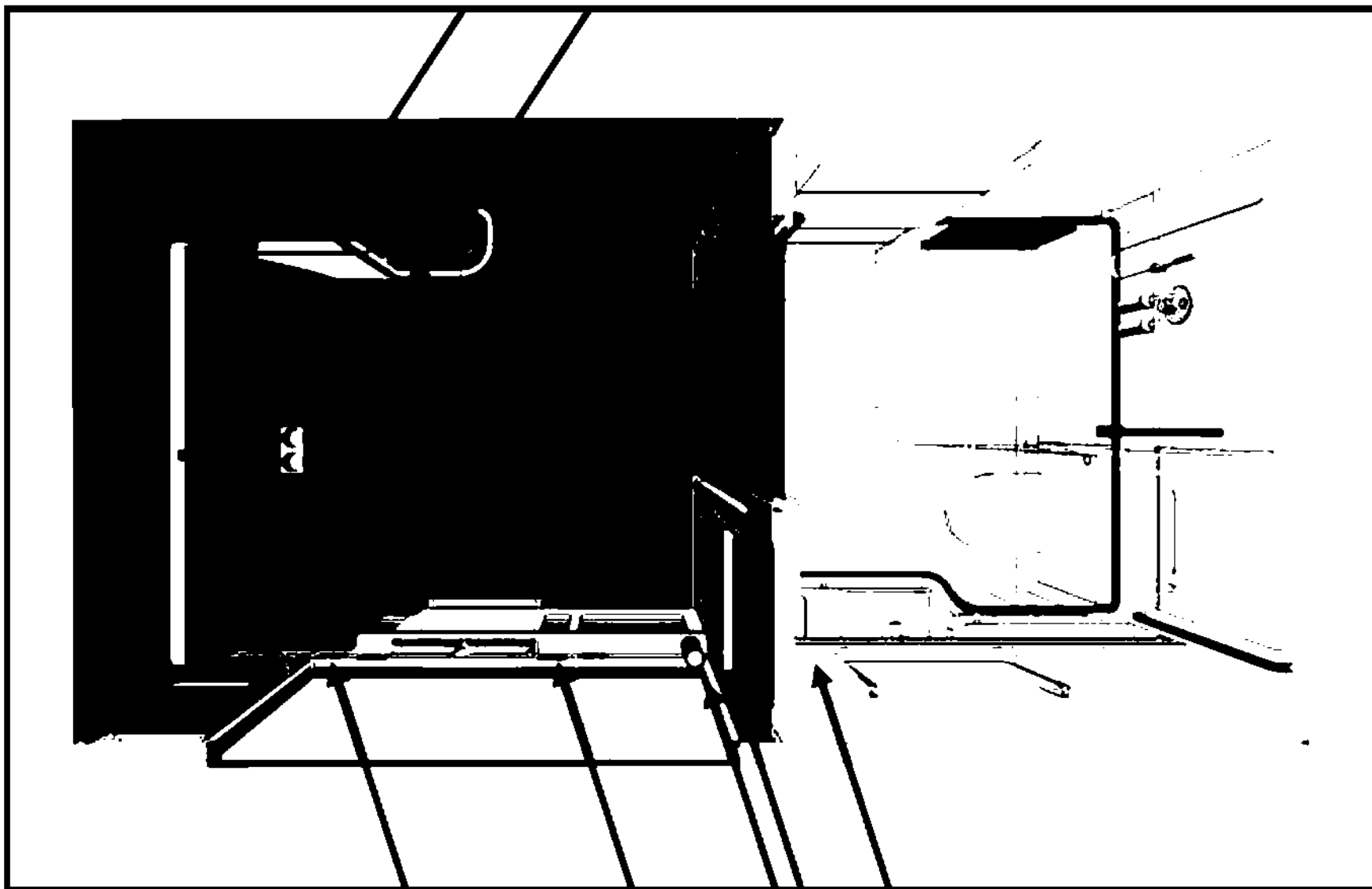

Figure 11-100: Accessible Twin Outlet Locations

CONFIDENTIAL — DO NOT DISTRIBUTE



Figure 11-101: Accessible Twin Wash Light Locations

CONFIDENTIAL — DO NOT DISTRIBUTE

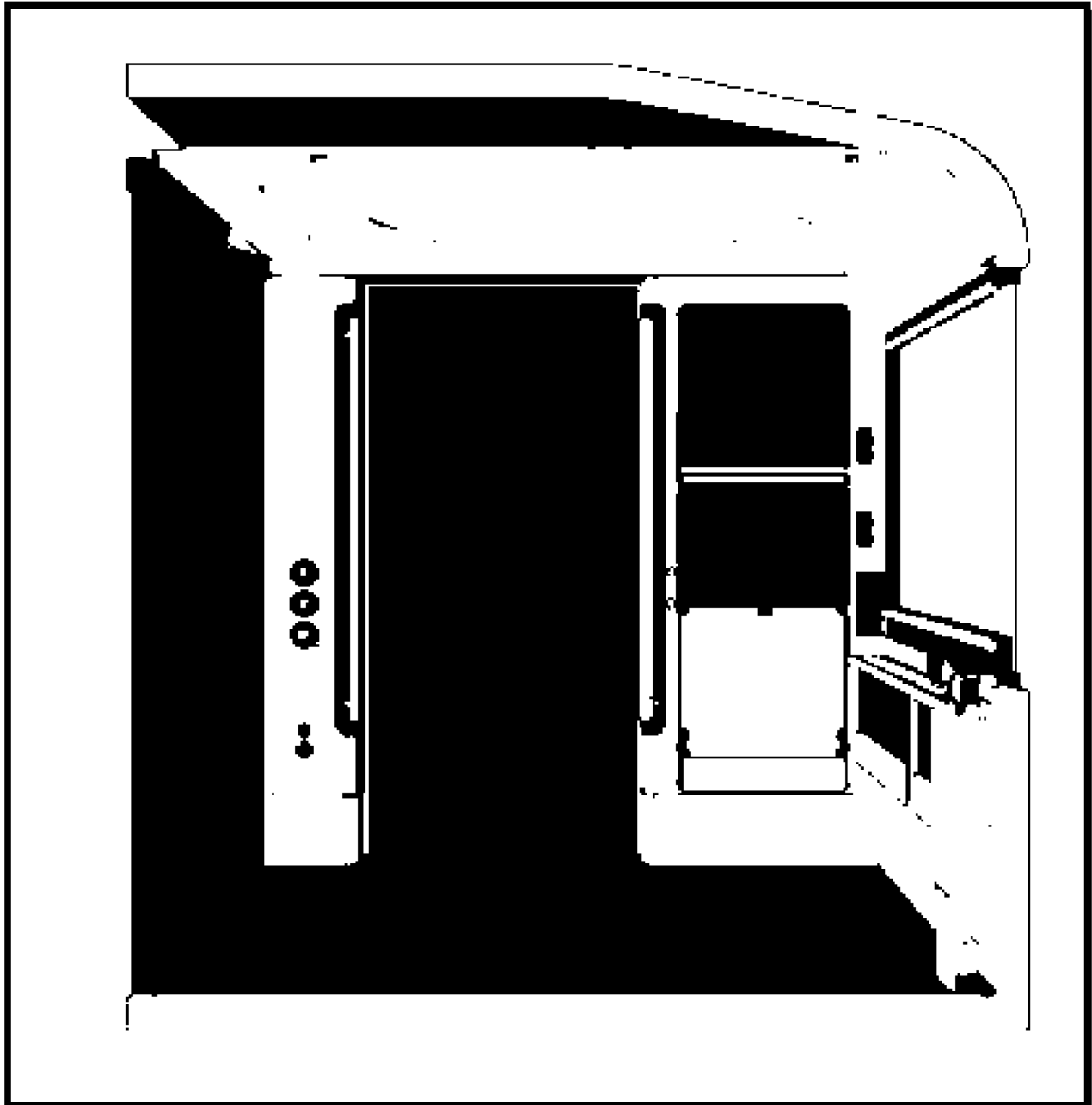

Figure 11-102: Accessible Twin Spot Light Locations

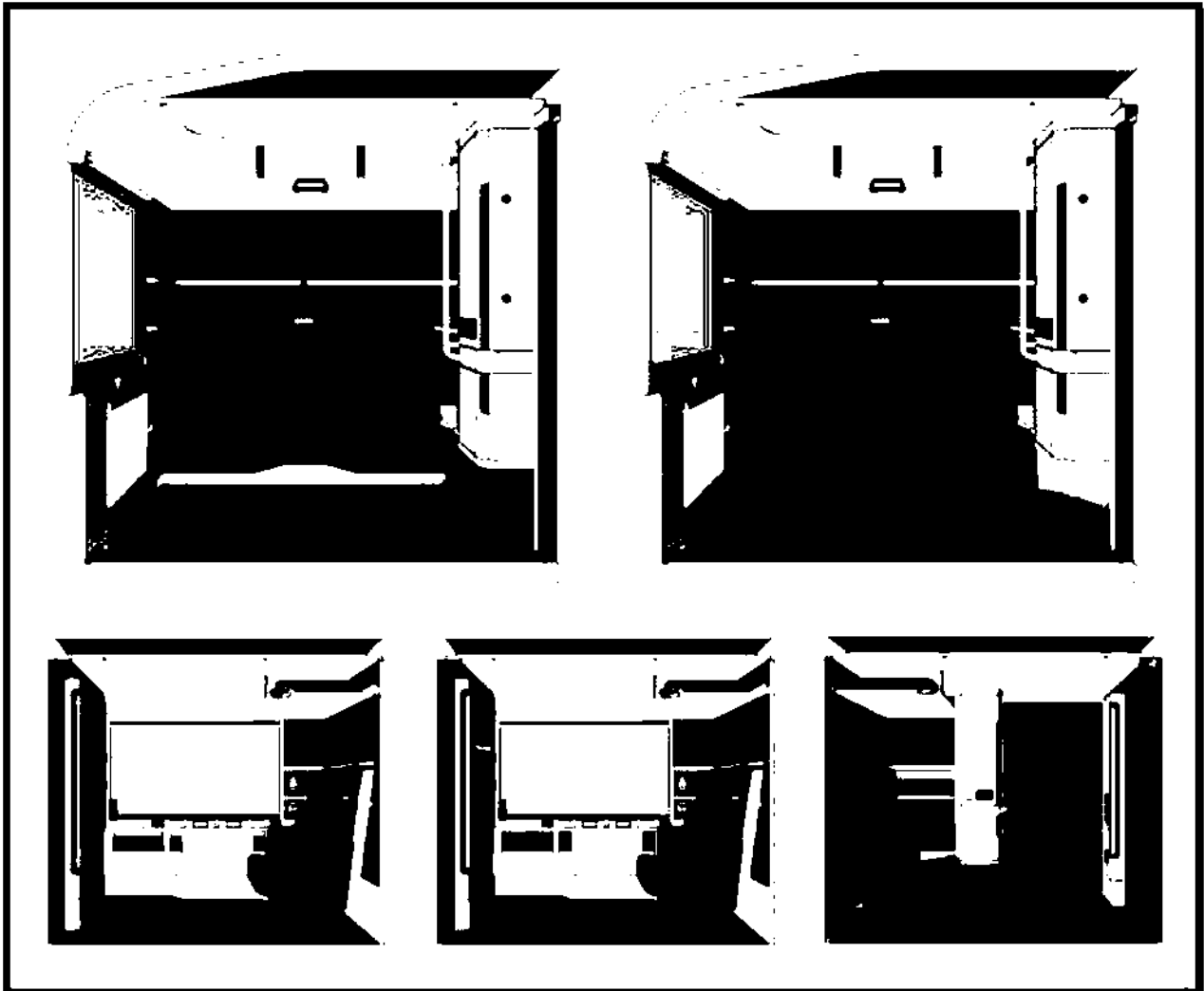

Figure 11-103: Accessible Twin Compartment Light Locations

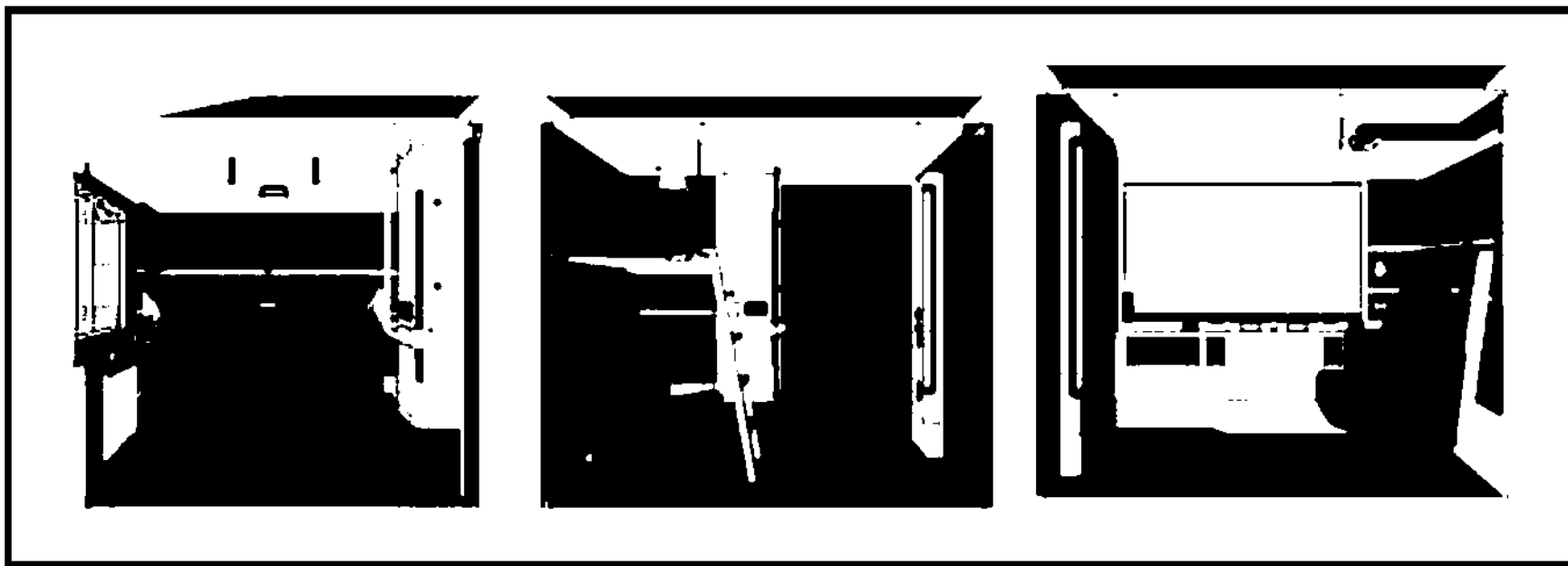

Figure 11-104: Accessible Twin Reading Light Locations

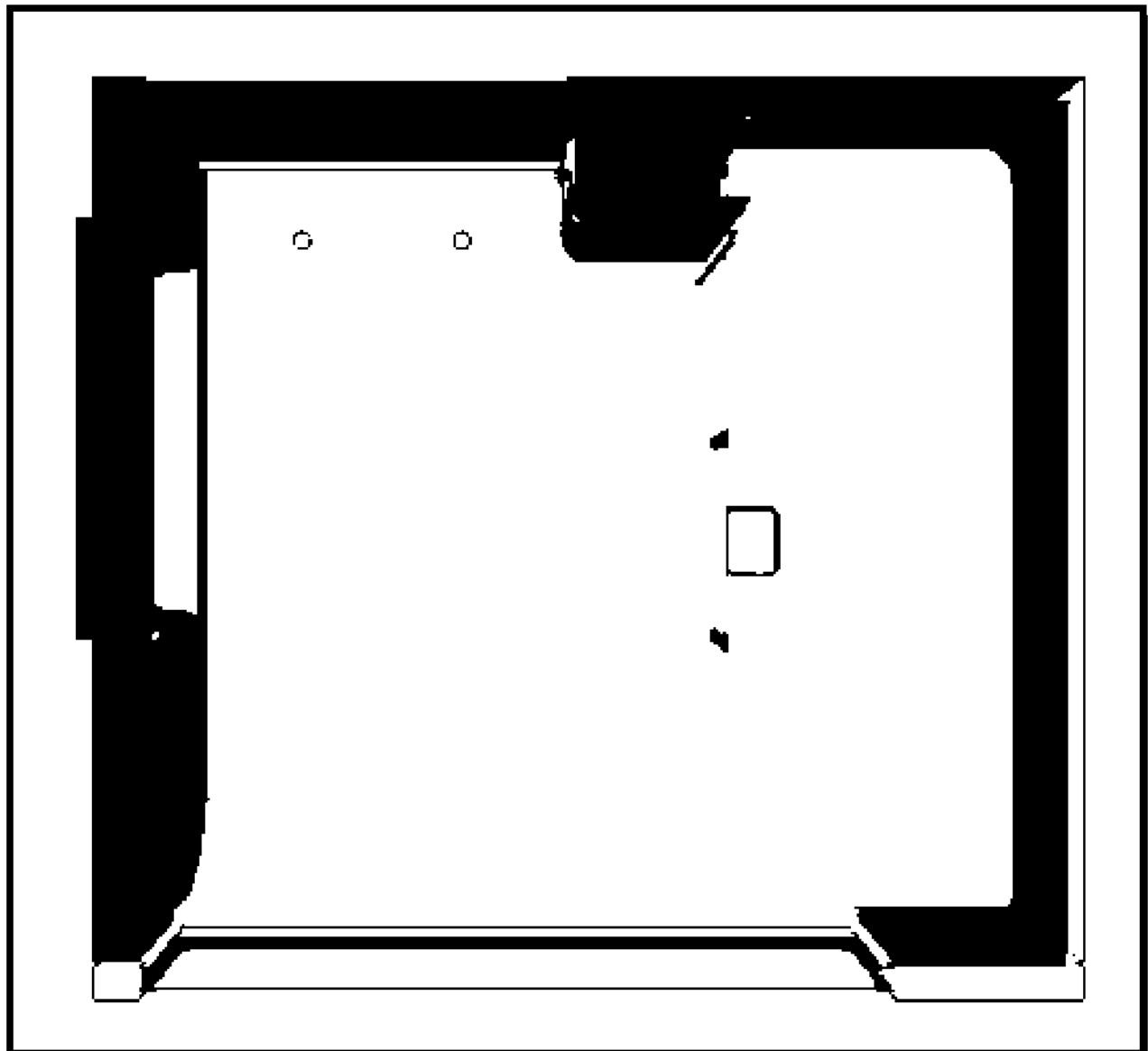

Figure 11-105: Accessible Twin Ceiling Pool Light Locations

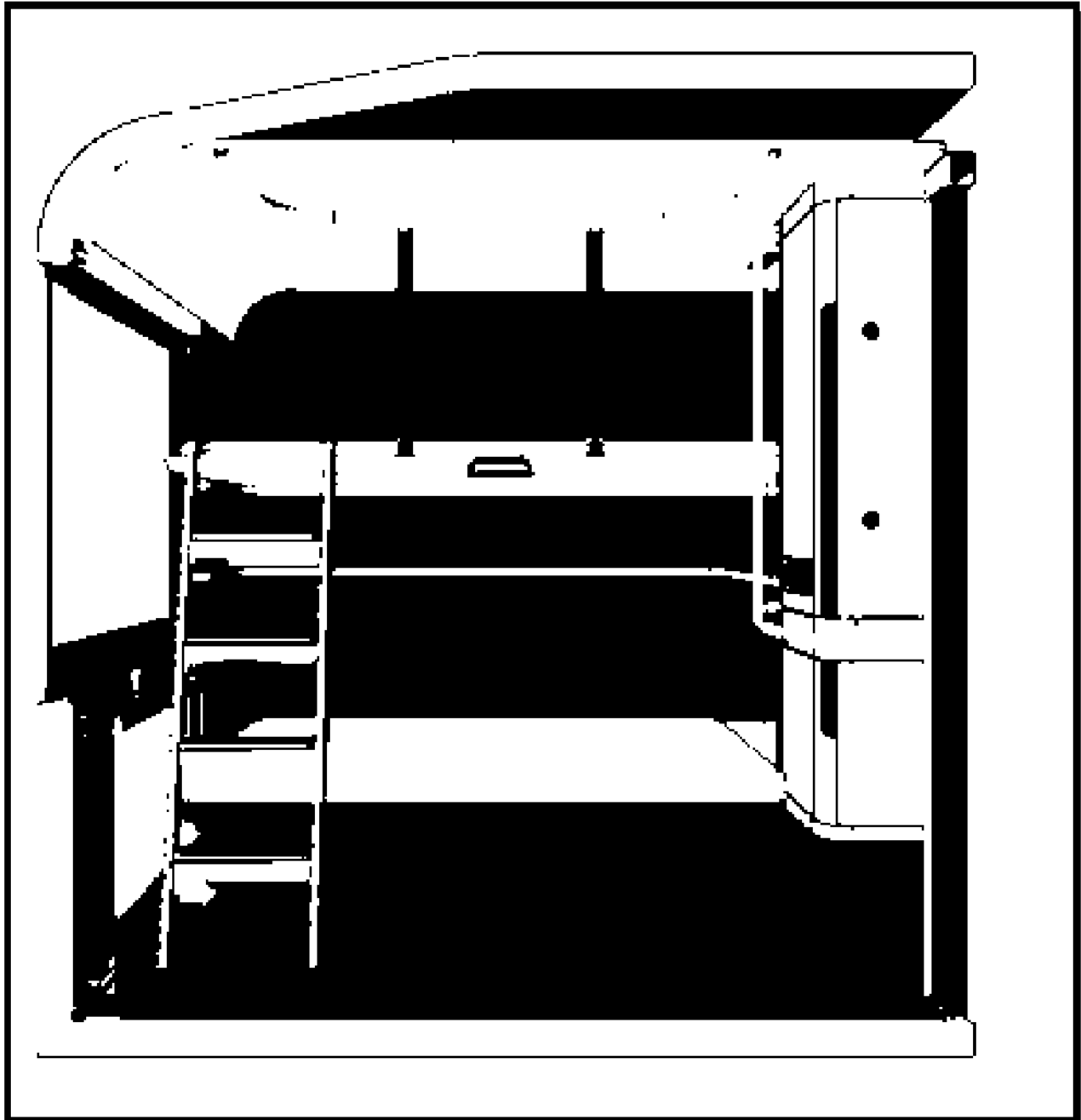

Figure 11-106: Accessible Twin Ladder Light Locations

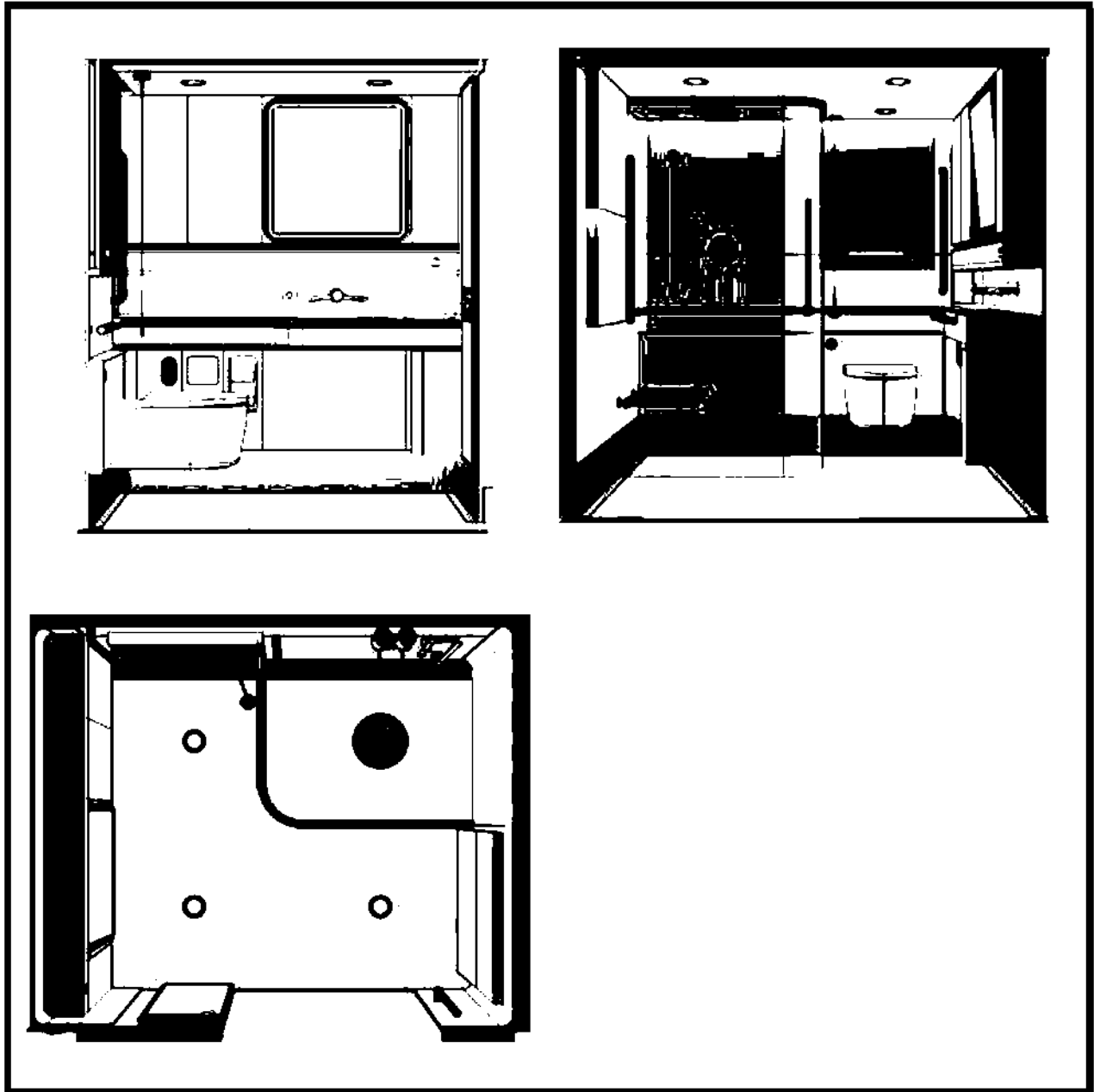

Figure 11-107: Accessible Sleeper Cabin Restroom Lighting



Figure 11-108: Accessible Double Cabin

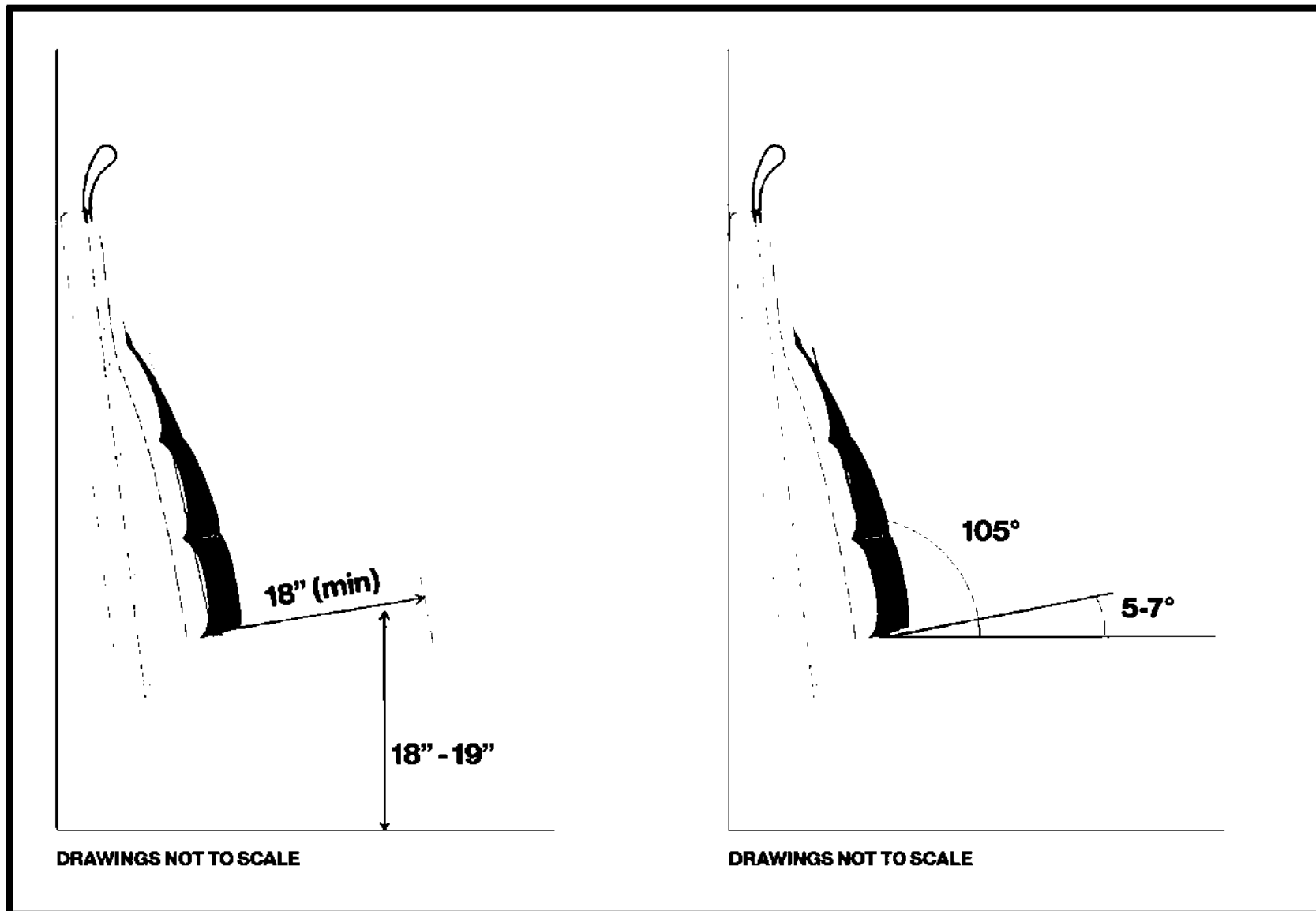

Figure 11-109: Accessible Double Seat Dimensions

CONFIDENTIAL — DO NOT DISTRIBUTE

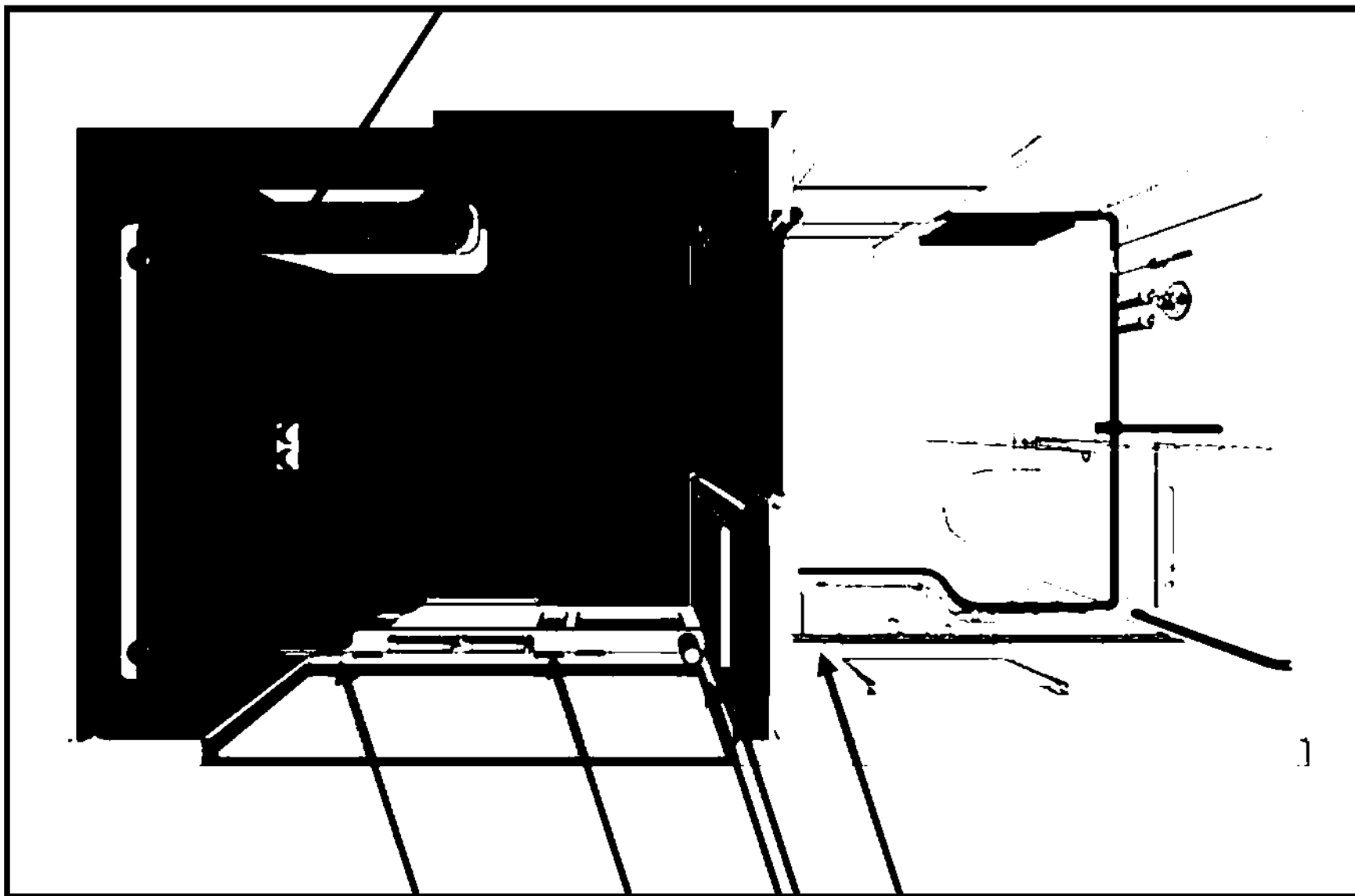

Figure 11-110: Accessible Double Outlet Locations

CONFIDENTIAL — DO NOT DISTRIBUTE

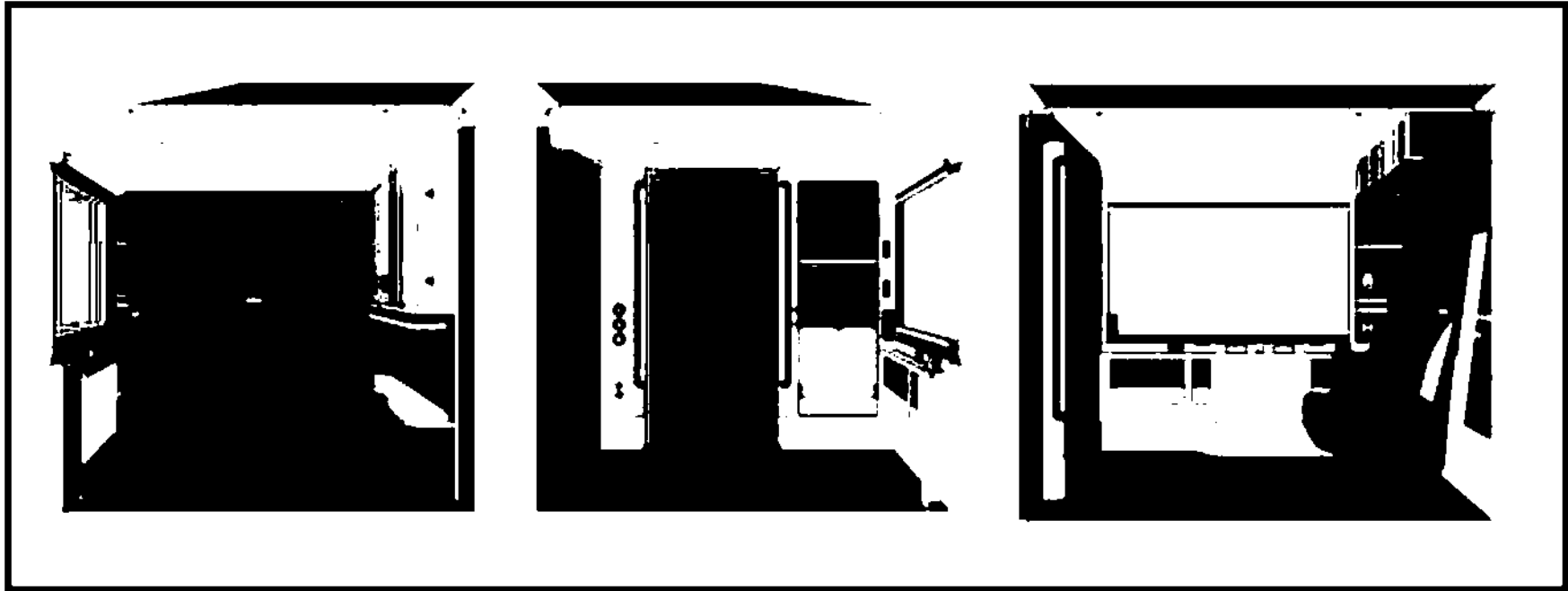

Figure 11-111: Accessible Double Wash Light Locations

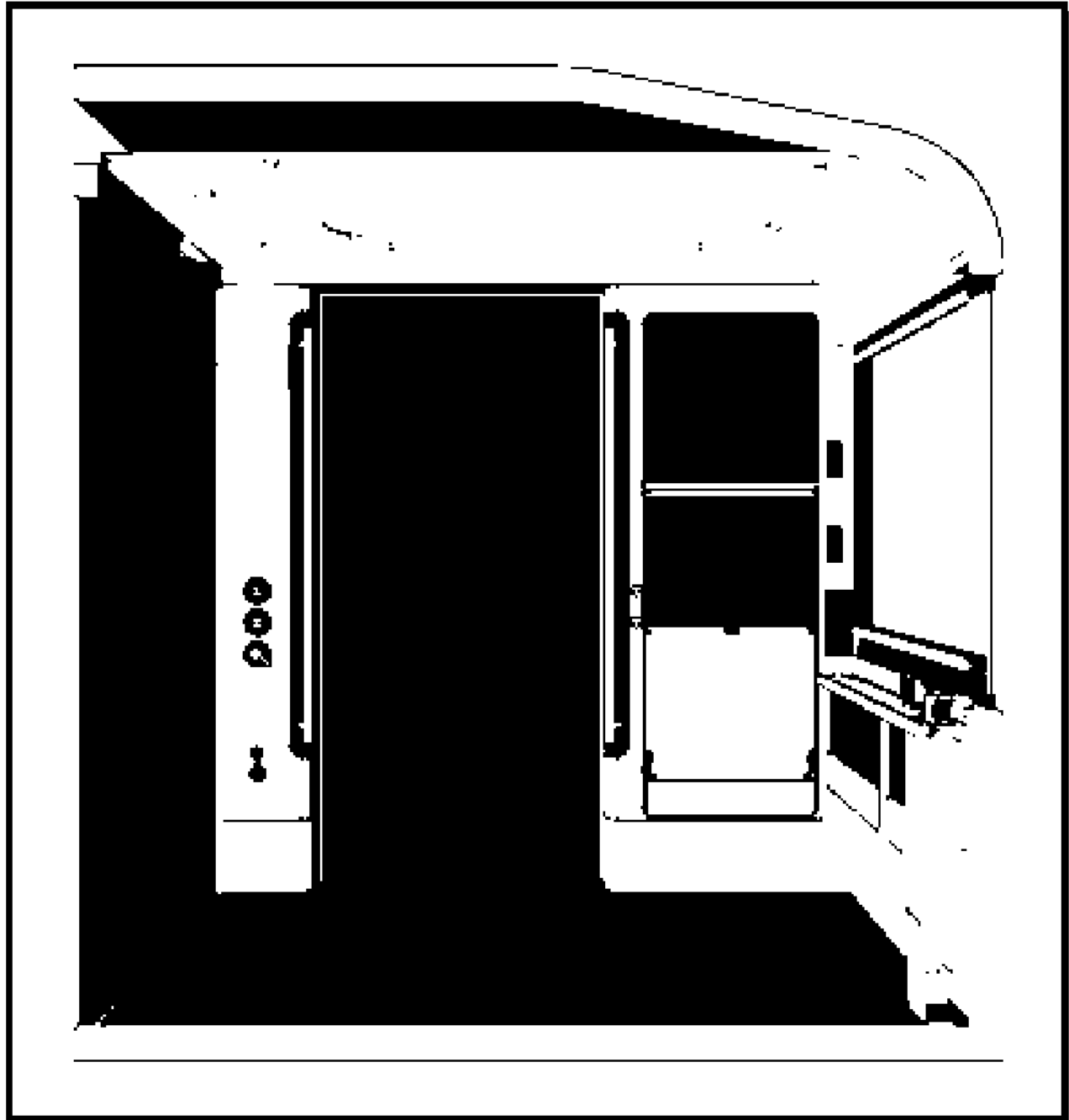

Figure 11-112: Accessible Double Spot Light Locations

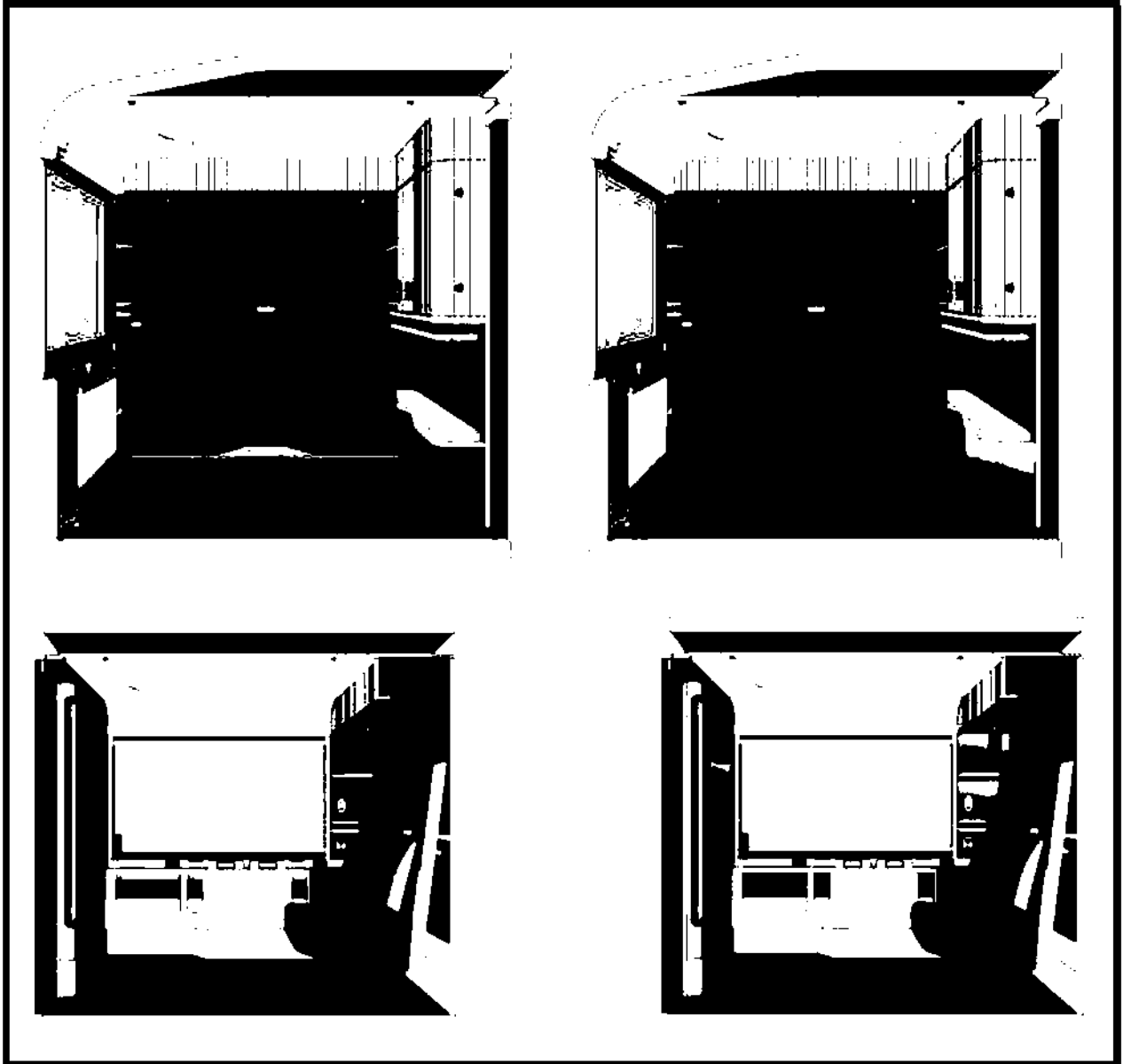

Figure 11-113: Accessible Double Compartment Light Locations

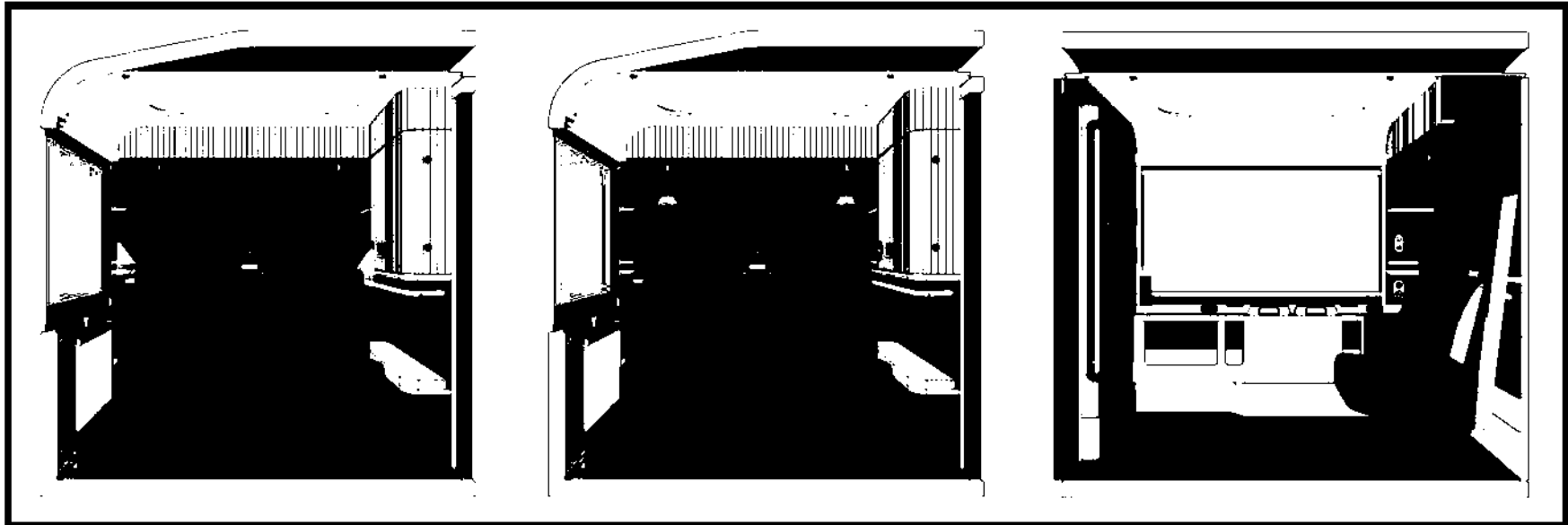

Figure 11-114: Accessible Double Reading Light Locations

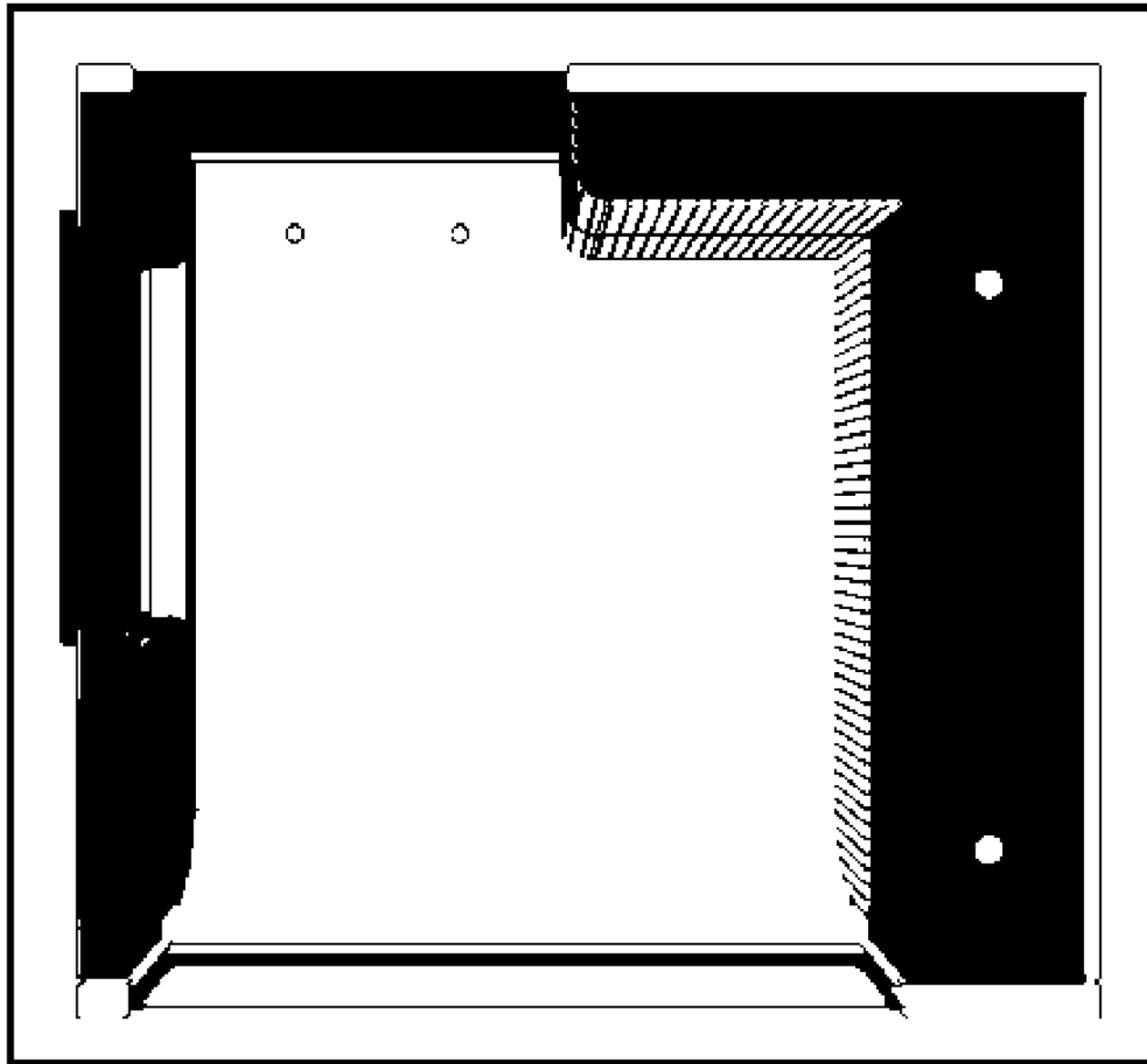

Figure 11-115: Accessible Double Ceiling Pool Light Locations

CONFIDENTIAL — DO NOT DISTRIBUTE

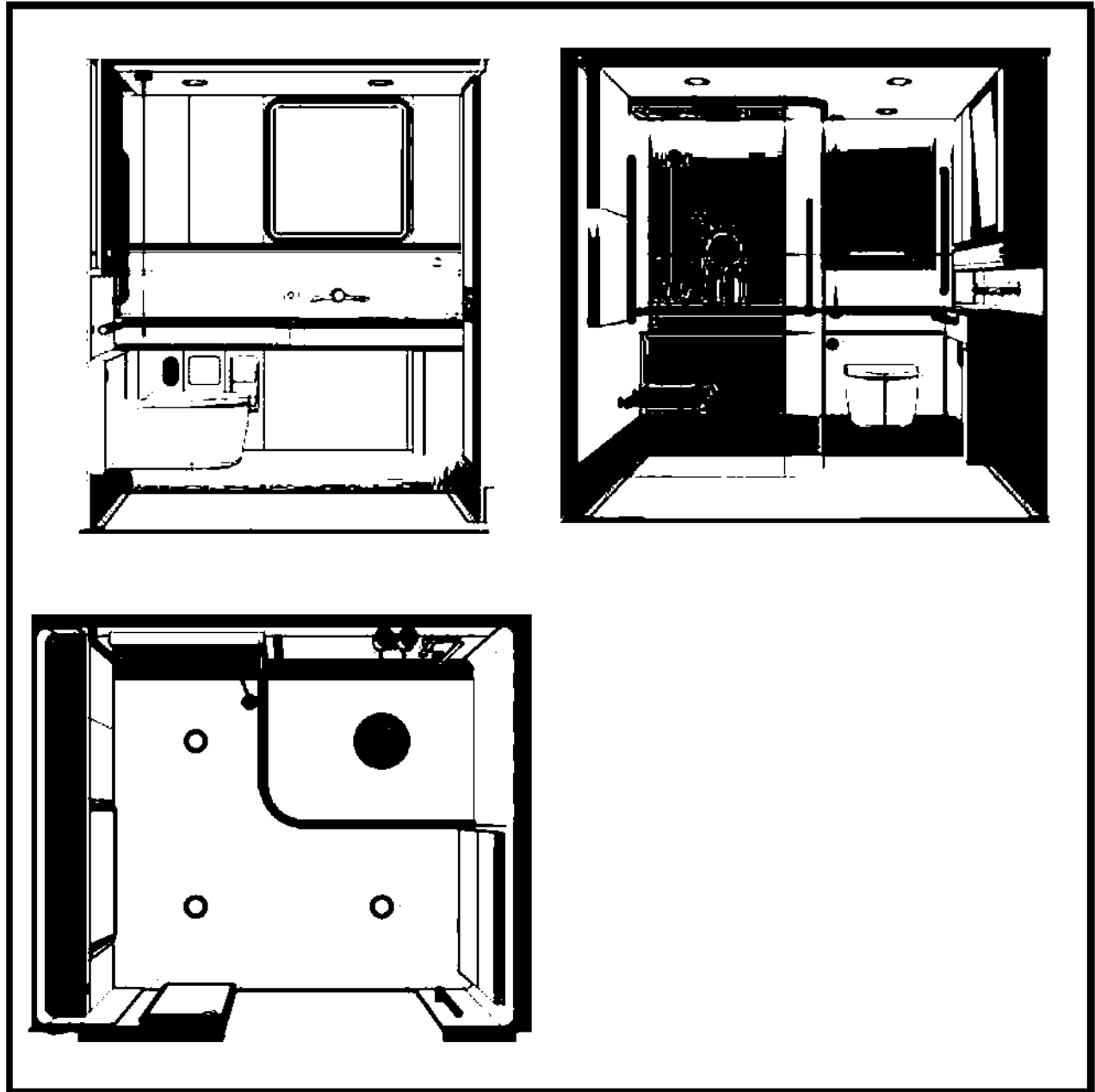

Figure 11-116: Accessible Sleeper Cabin Restroom Lighting

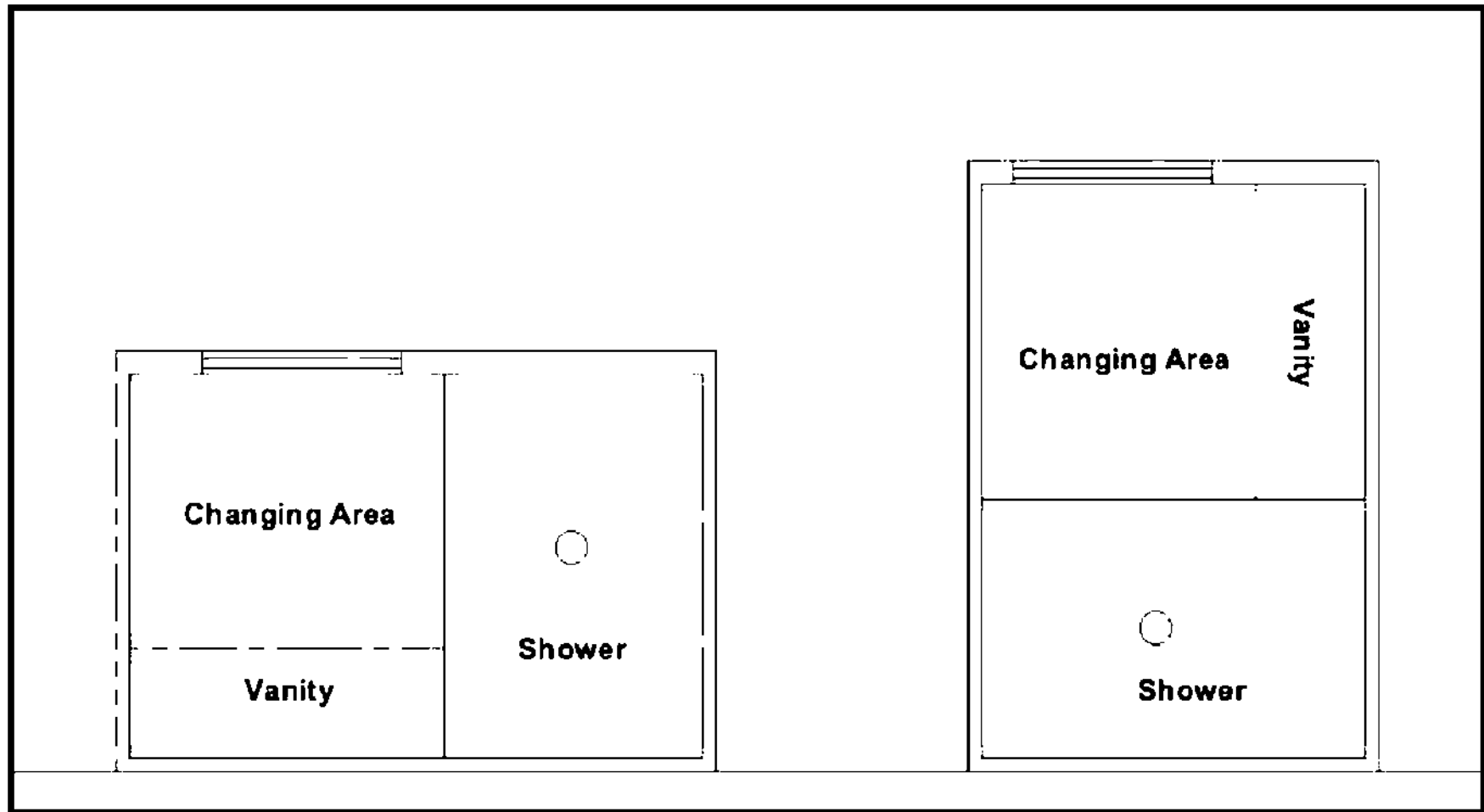

Figure 11-117: Sleeper Cabin Shower Modular Design

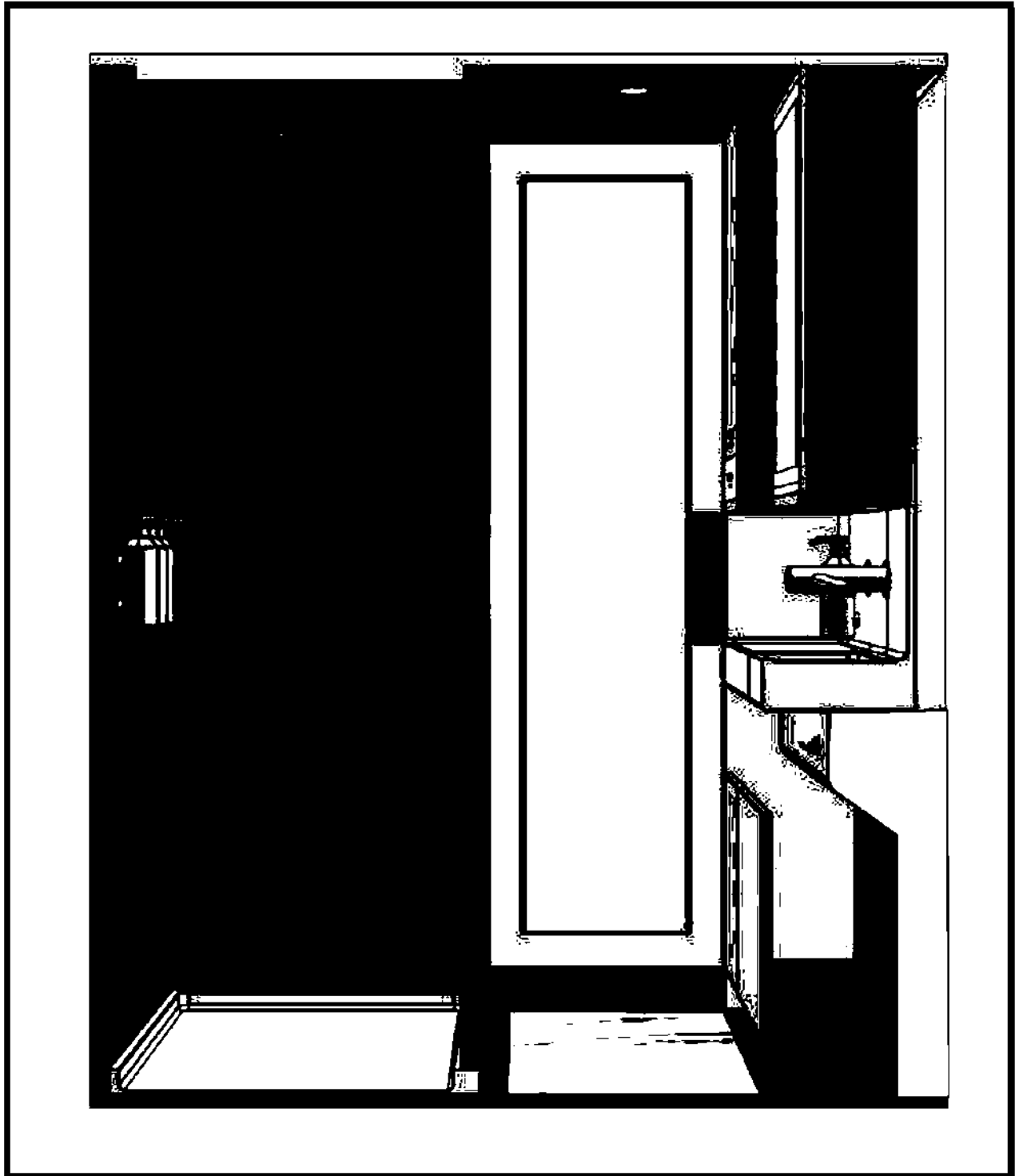

Figure 11-118: Shower for Sleeper Cabin Passengers

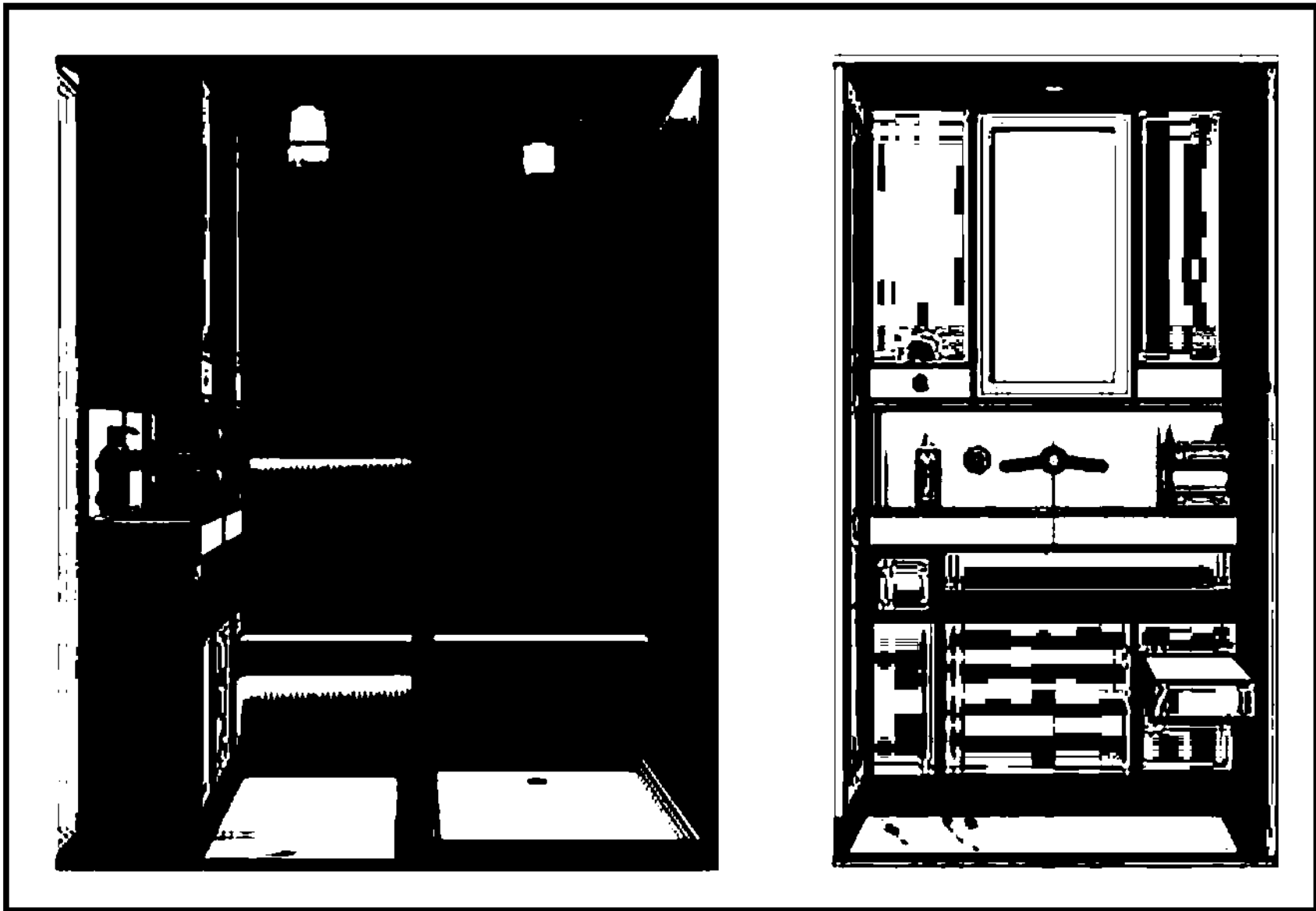

Figure 11-119: Shower Light Locations

CONFIDENTIAL — DO NOT DISTRIBUTE



Figure 11-120: Shower Electrical Outlet Locations

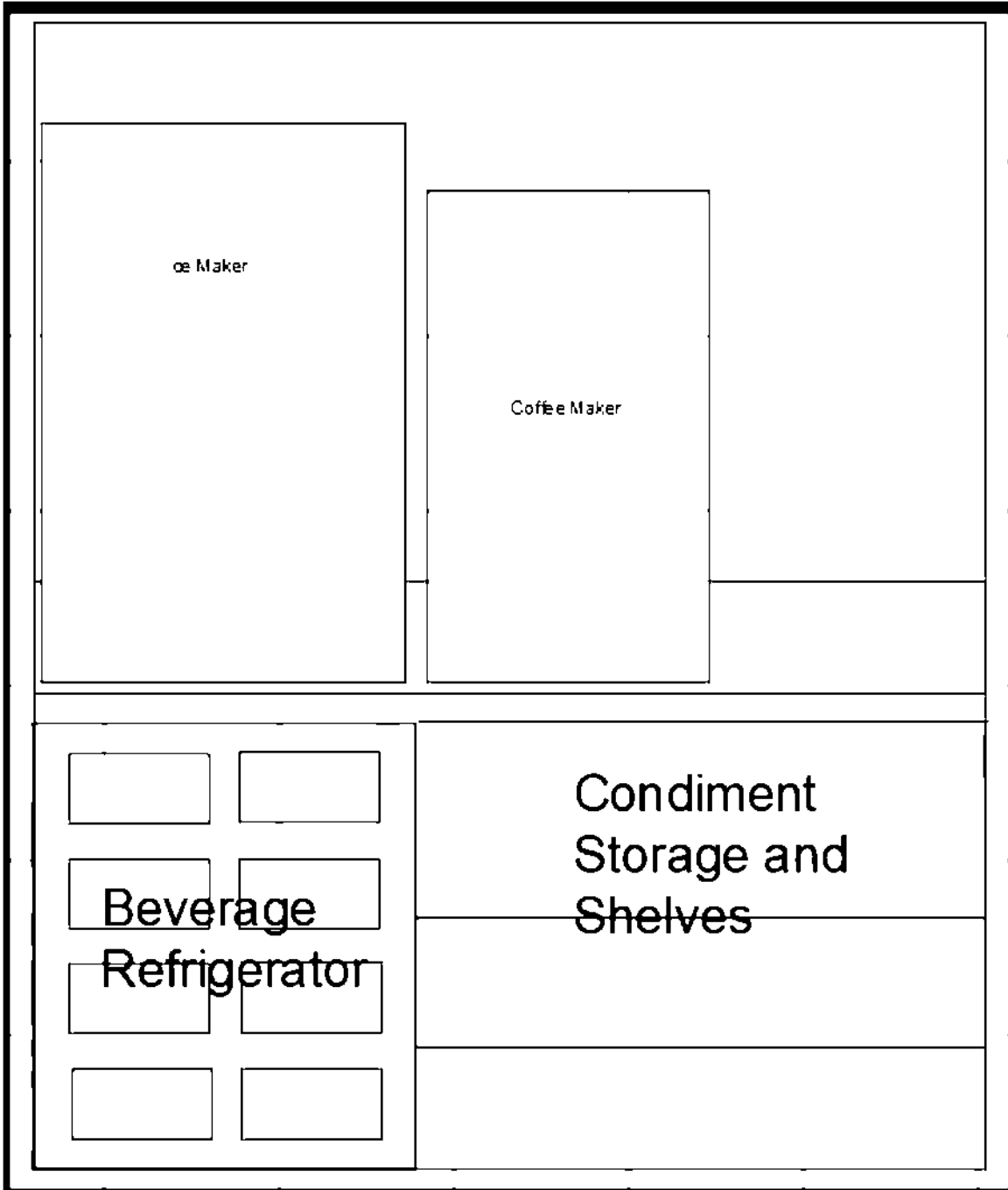

Figure 11-121: Beverage Station

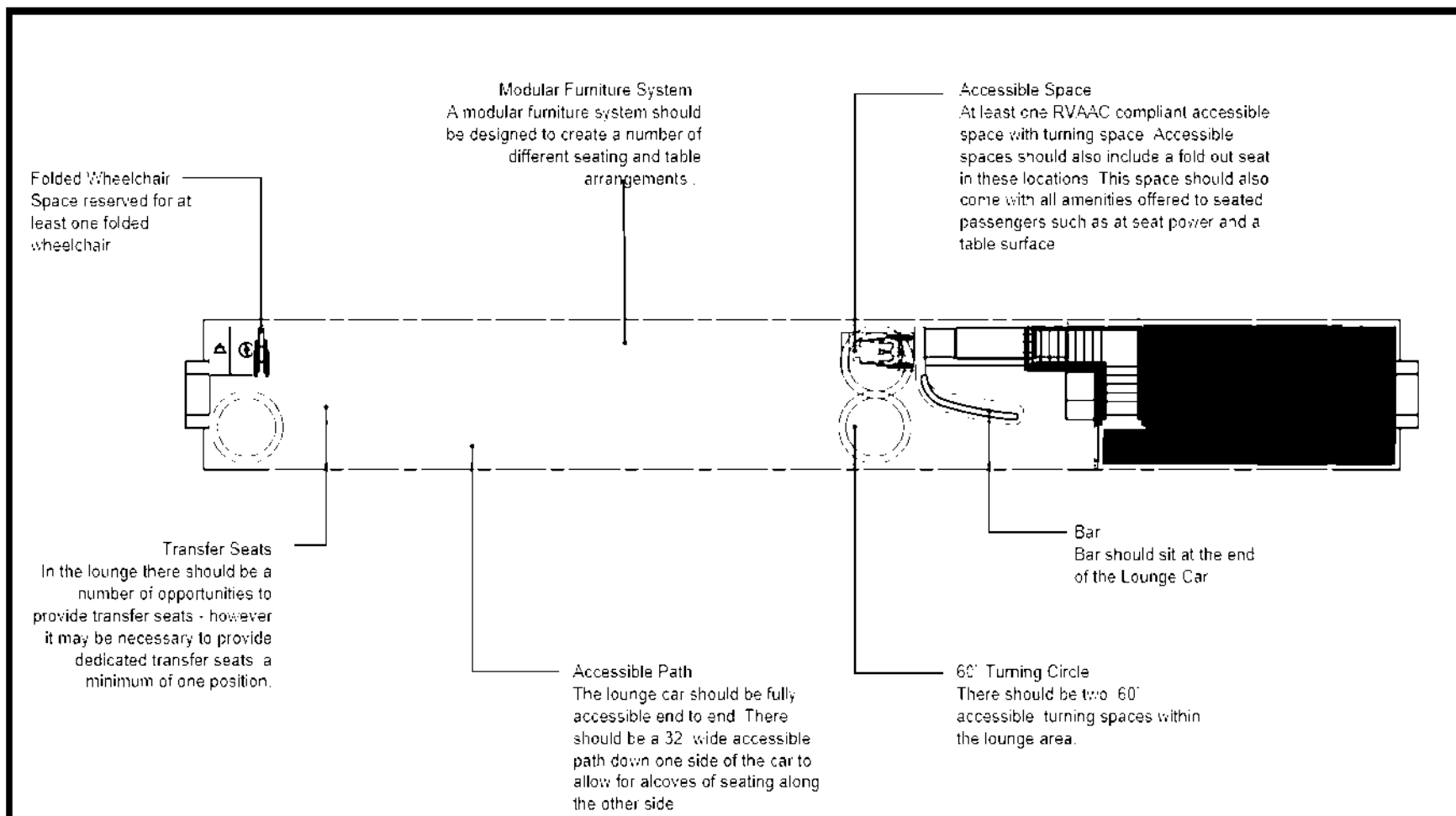

Figure 11-122: Suggested Layout - Lounge

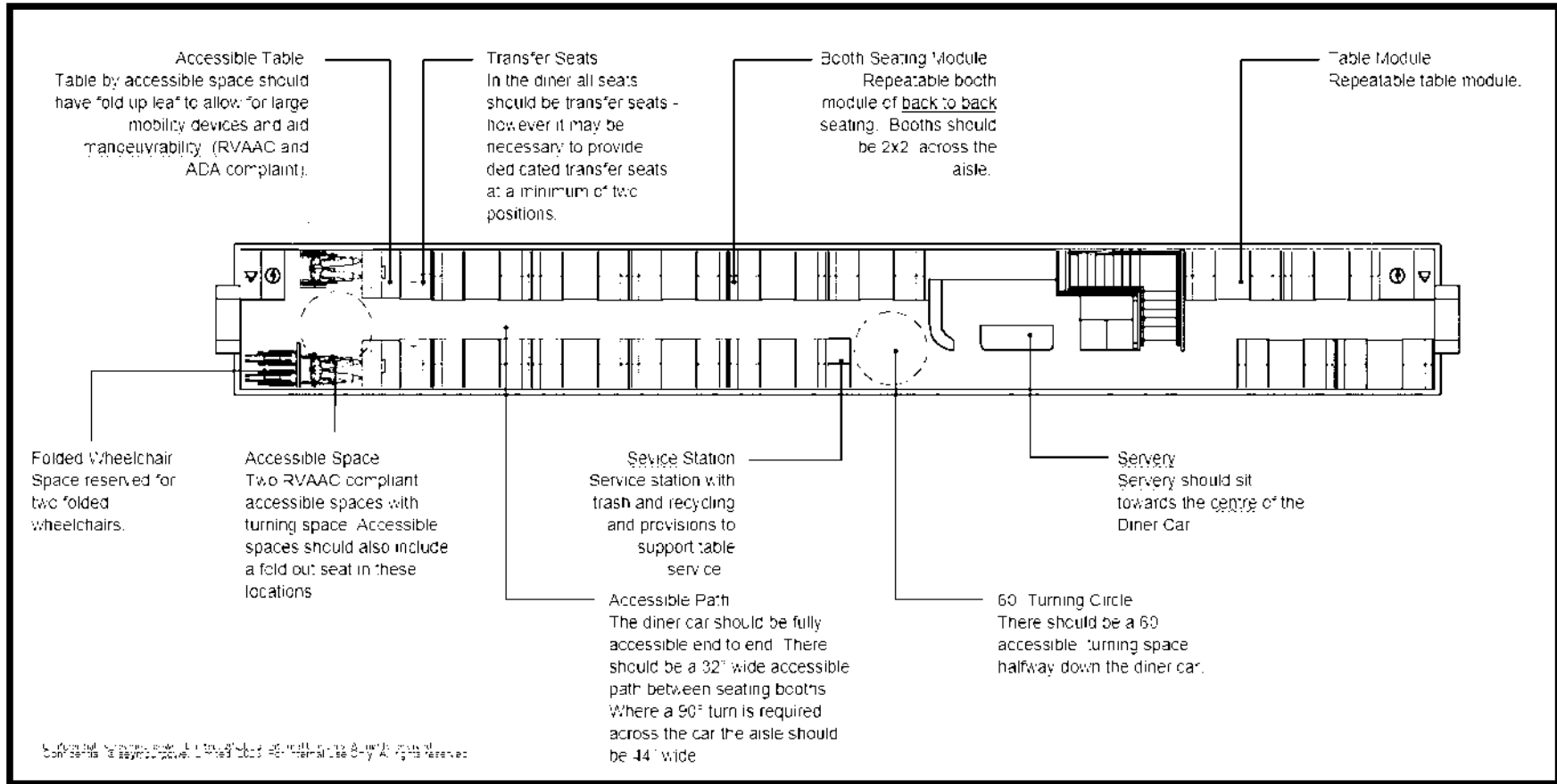

Figure 11-123: Suggested Layout - Diner

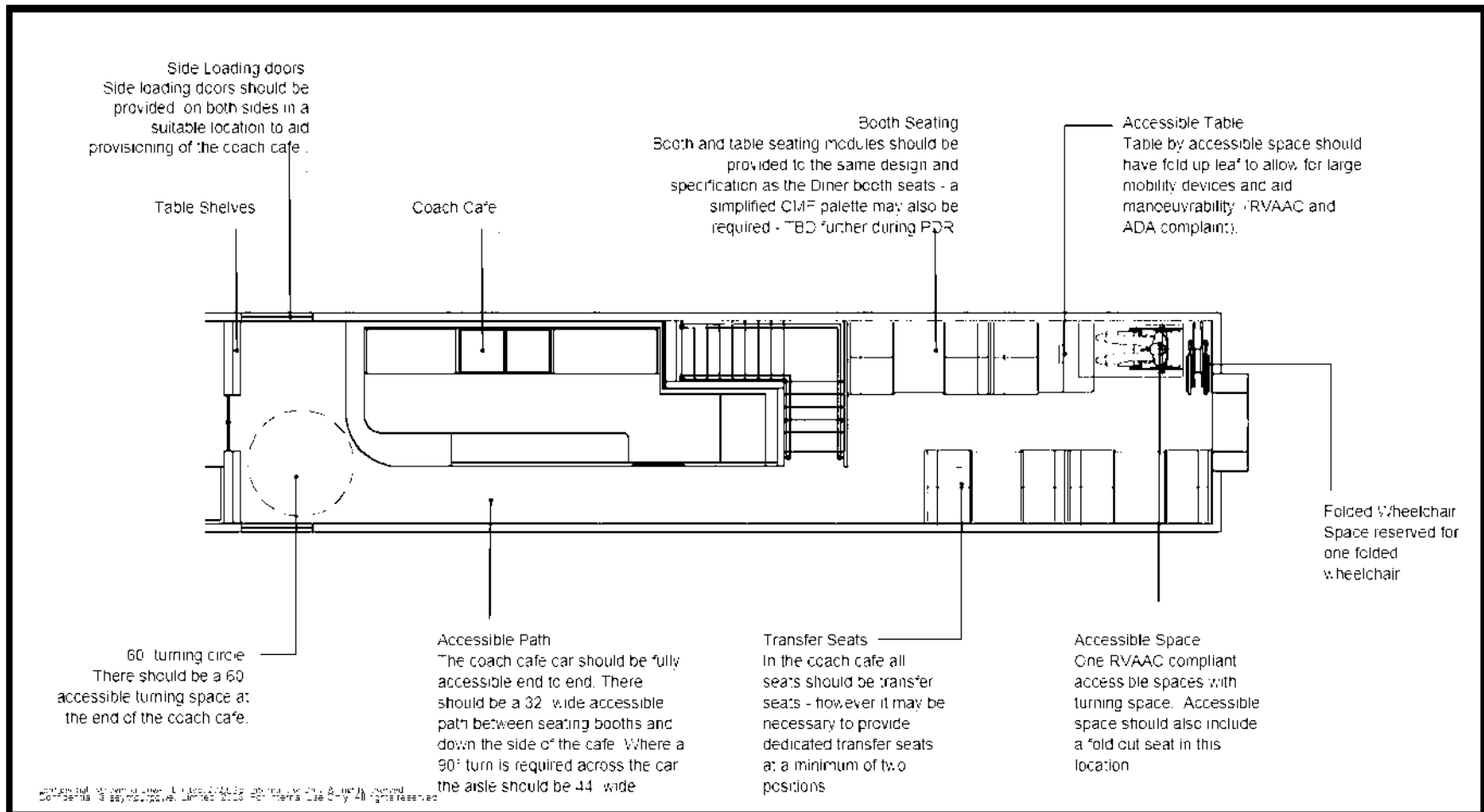

Figure 11-124: Suggested Layout - Café

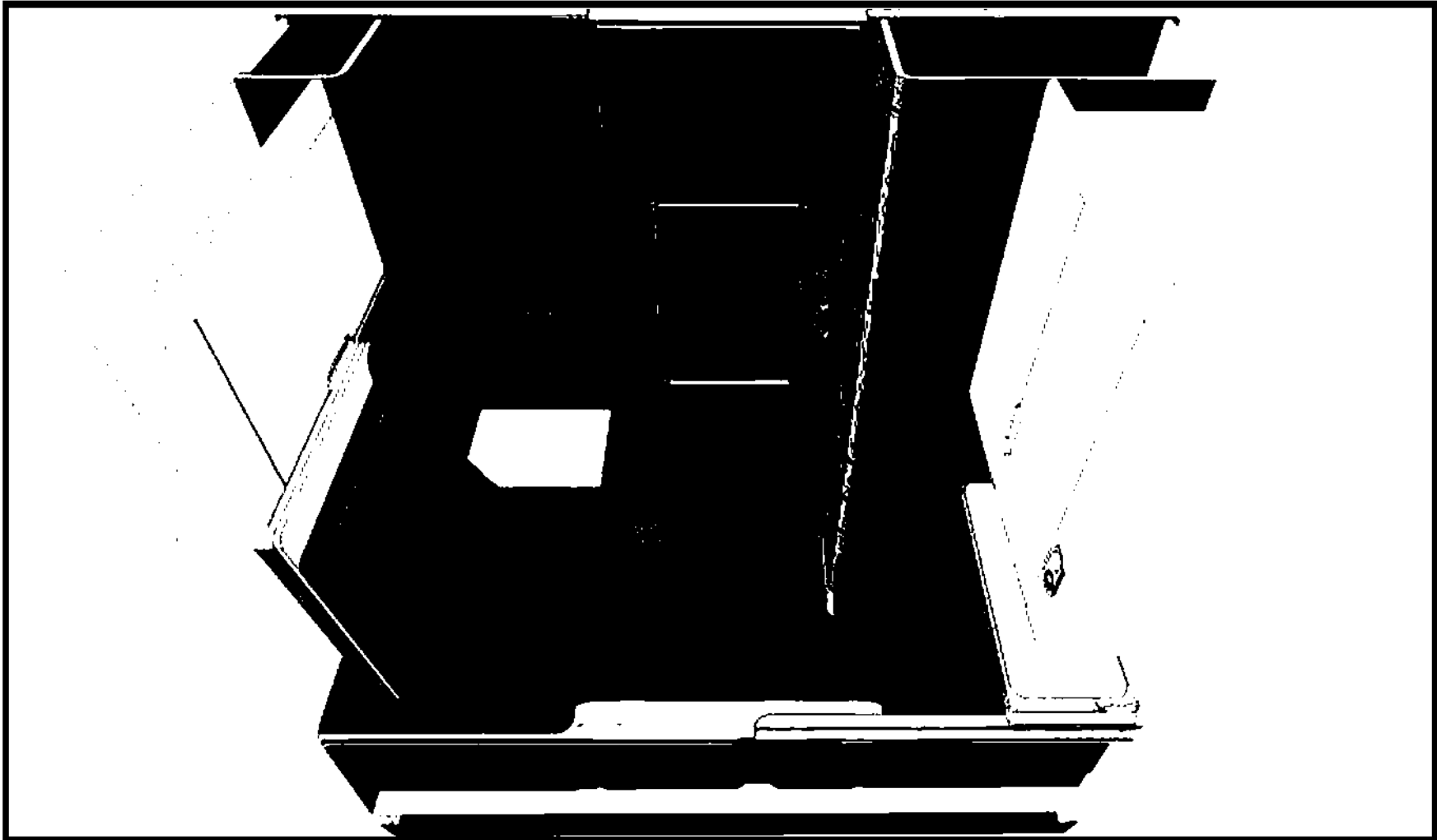

Figure 11-125: Crew Sleeper Cabin

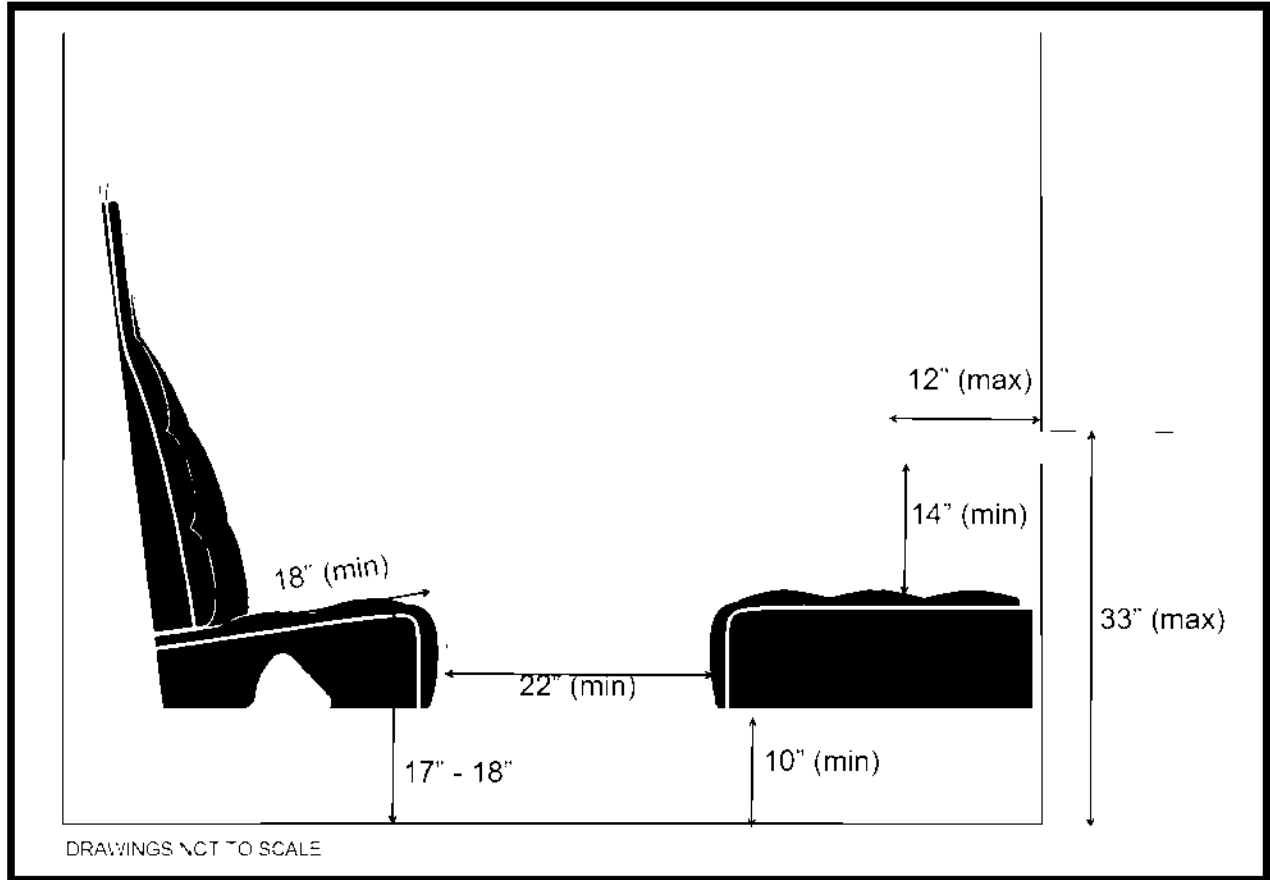

Figure 11-126: Crew Sleeper Cabin Seat Dimensions

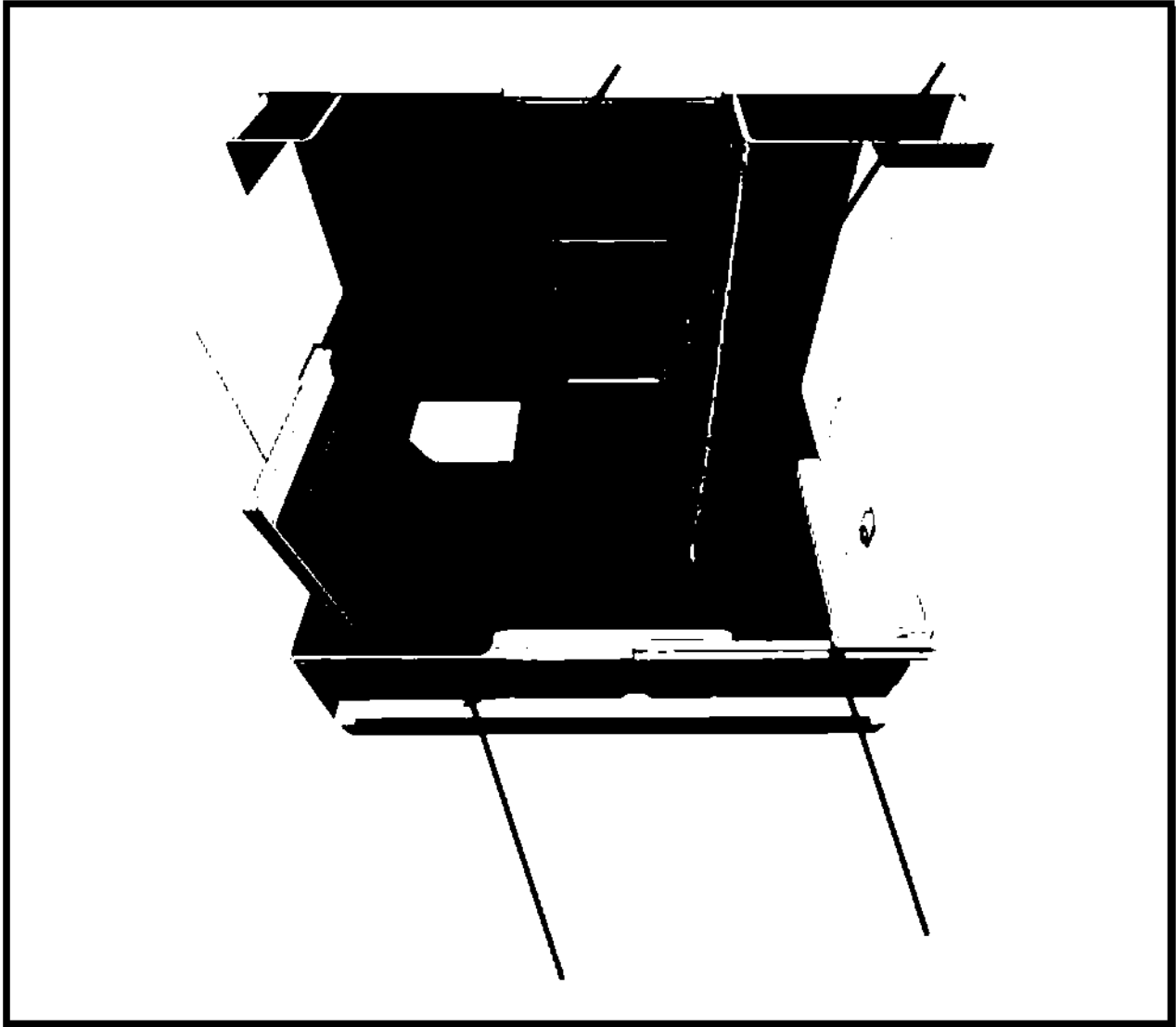

Figure 11-127: Crew Sleeper Outlet Locations

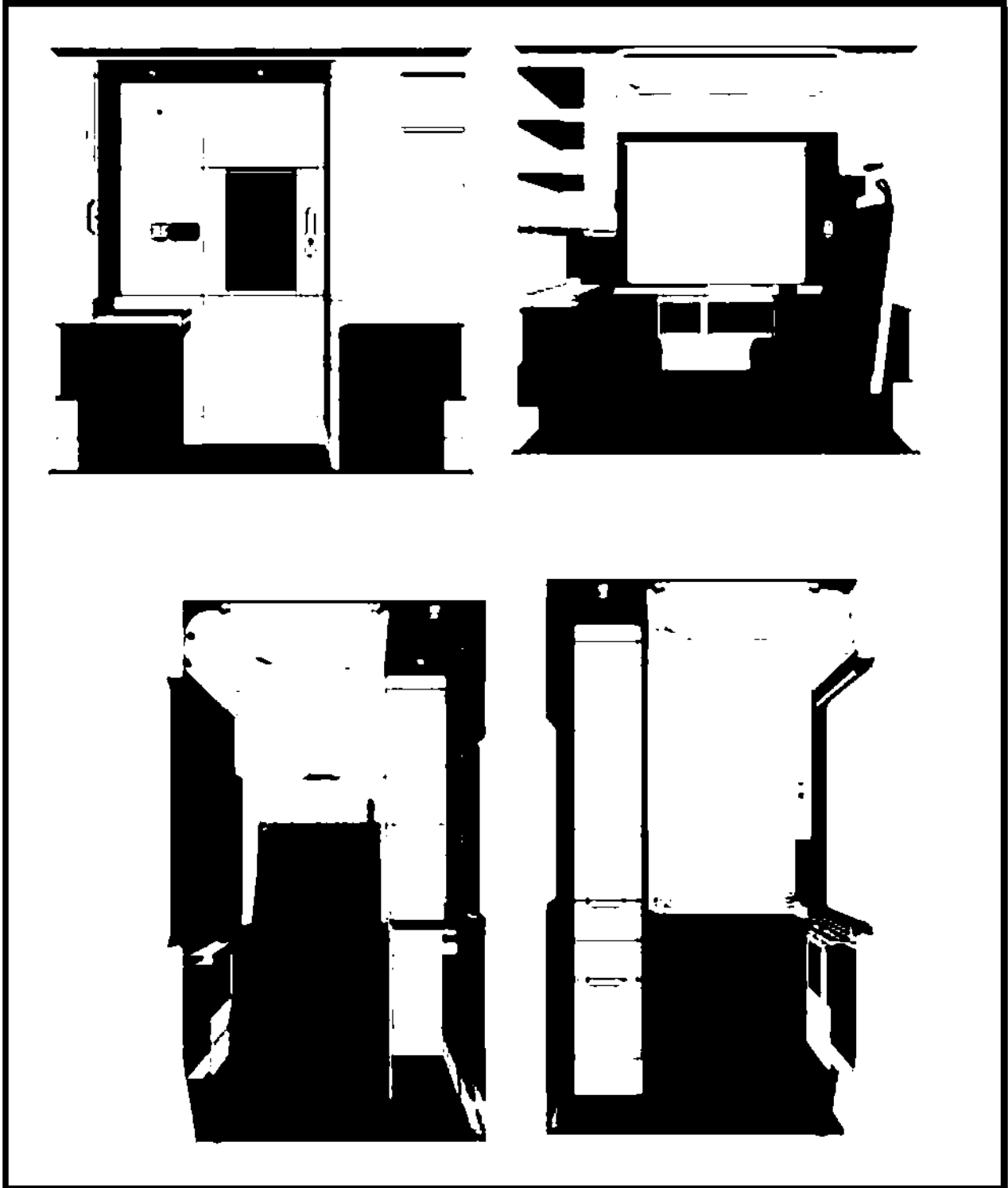

Figure 11-128: Crew Sleeper Wash Light Locations

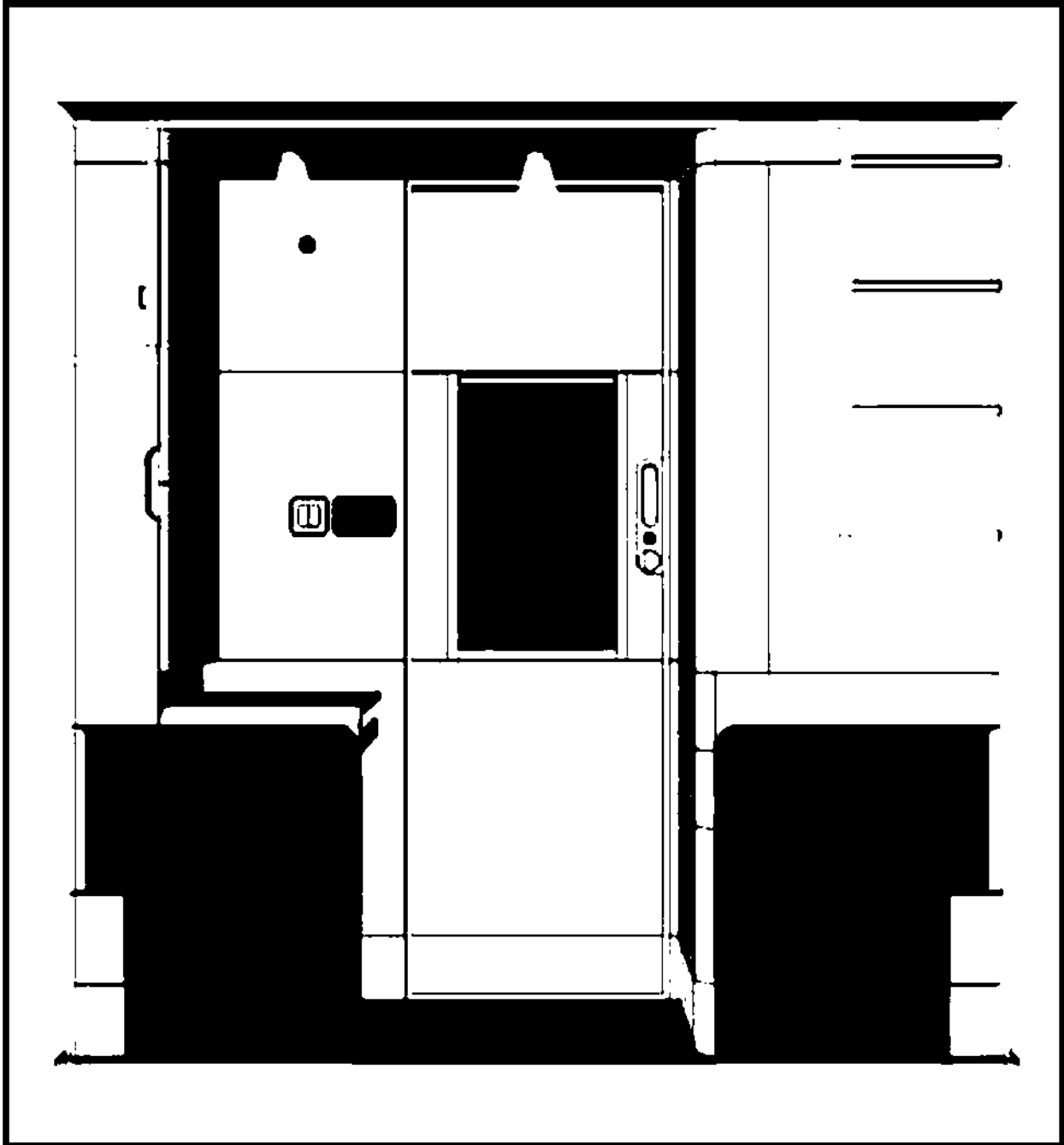

Figure 11-129: Crew Sleeper Spot Light Locations

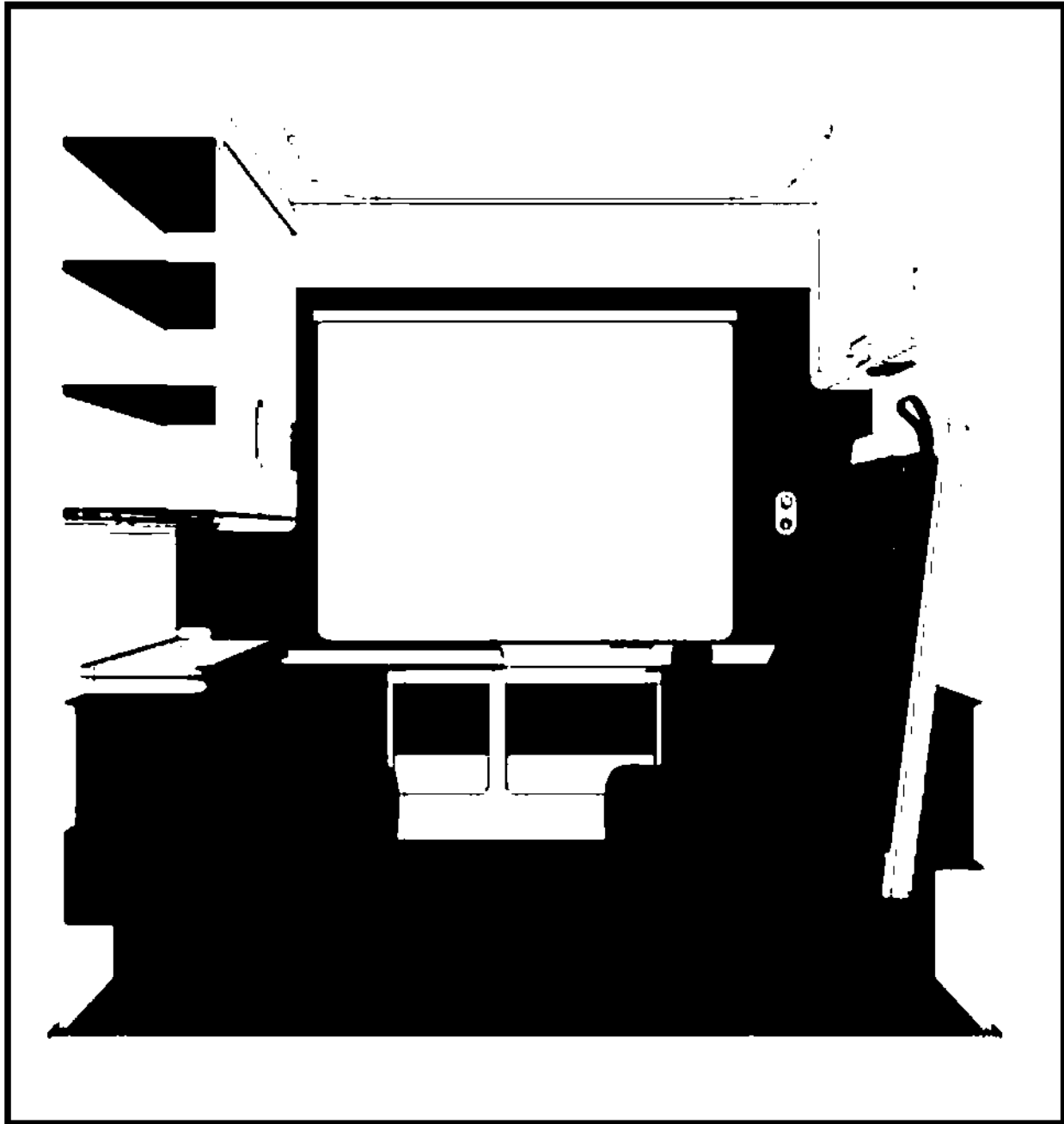

Figure 11-130: Crew Sleeper Ceiling Pool Light Locations

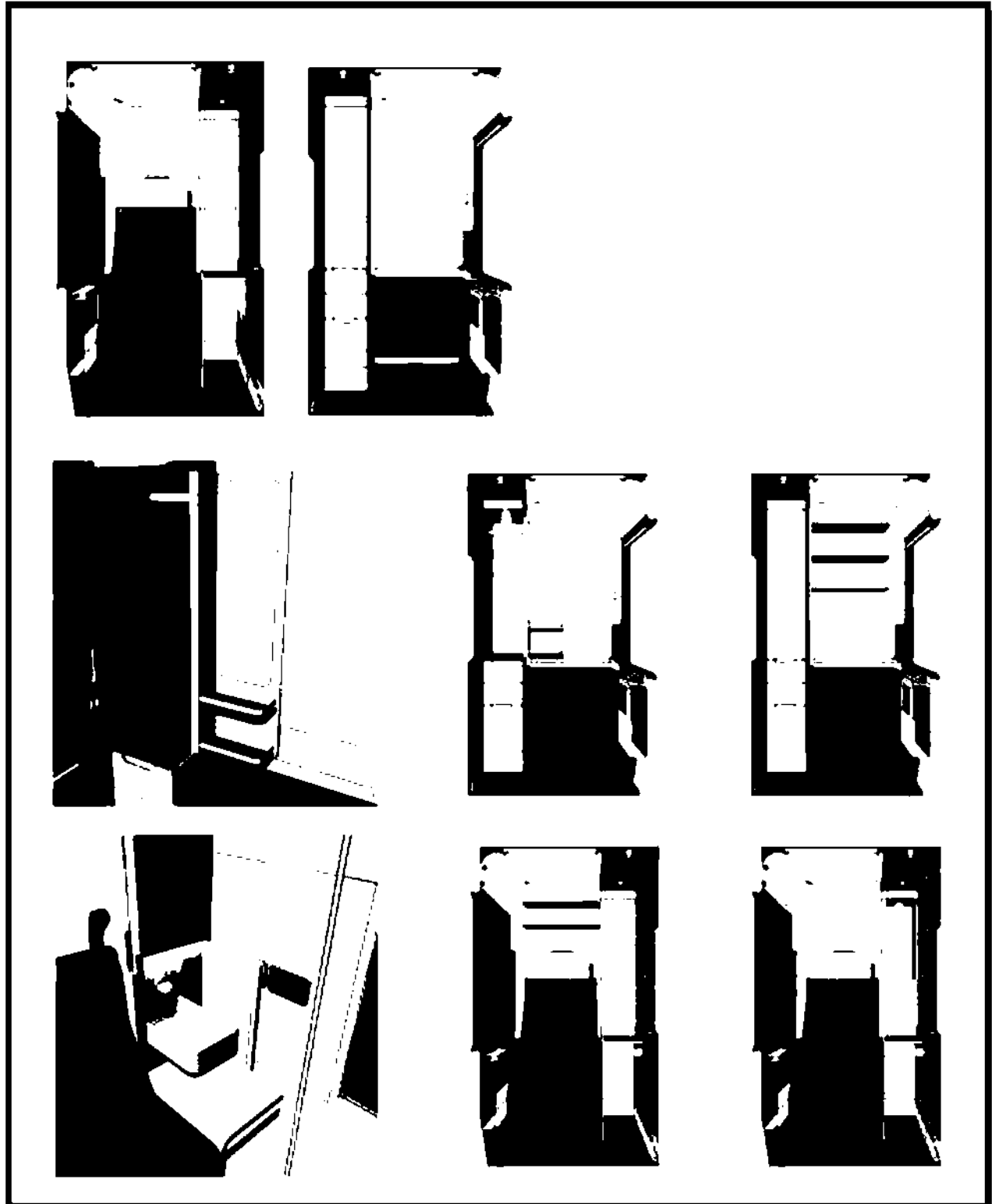

Figure 11-131: Crew Sleeper Compartment Light Locations

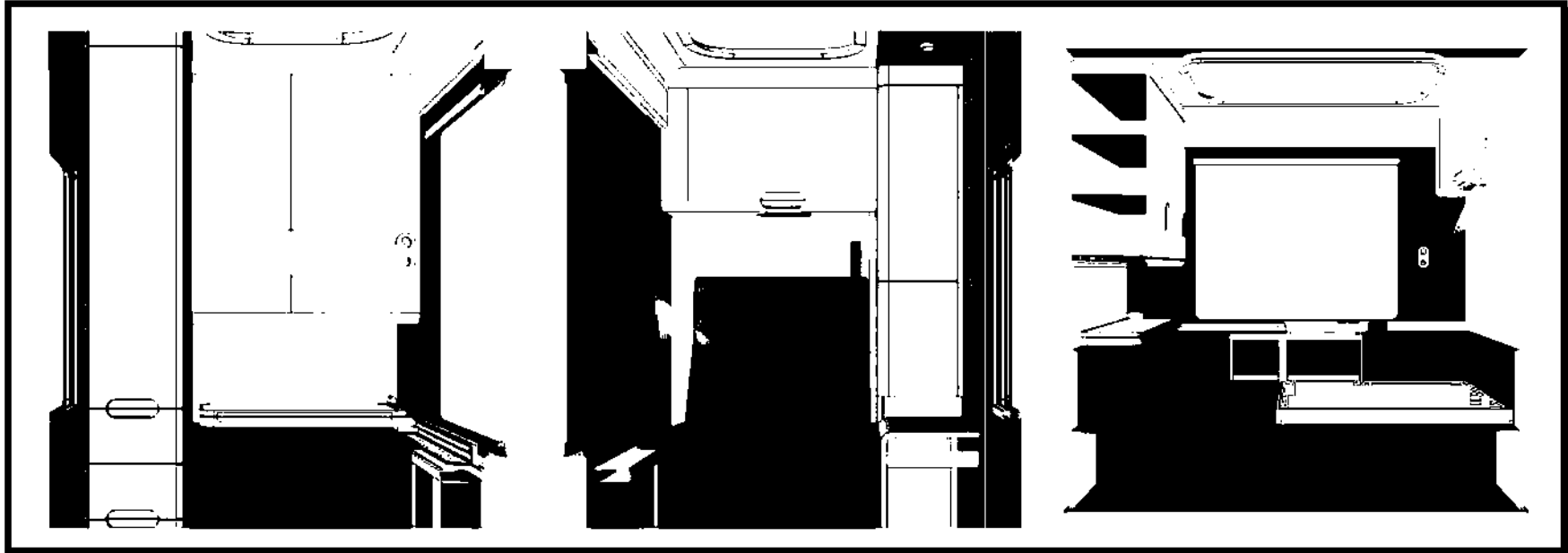

Figure 11-132: Crew Sleeper Reading Light Locations

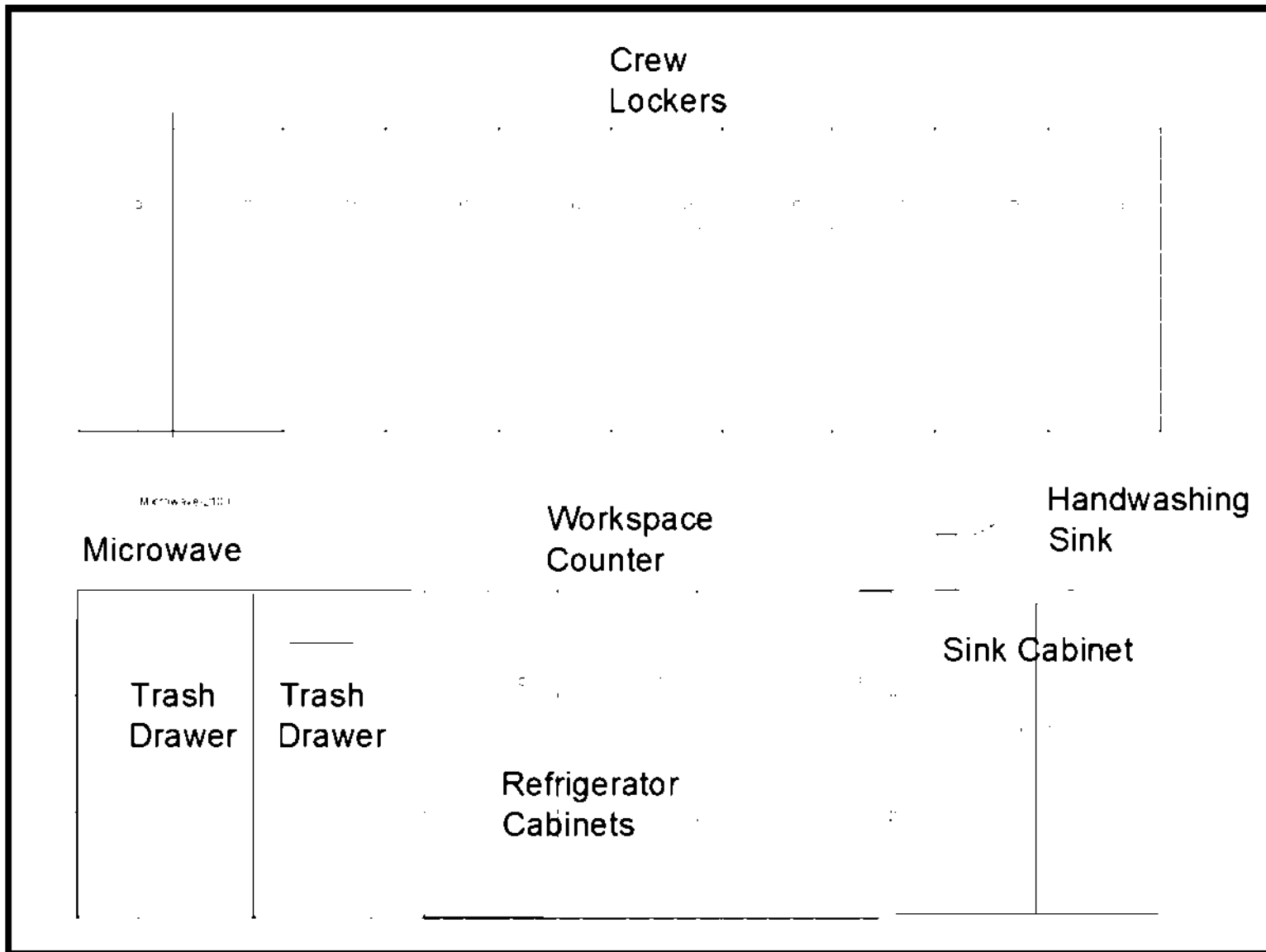

Figure 11-133: Crew Area Kitchenette

CONFIDENTIAL — DO NOT DISTRIBUTE

* End of Chapter 11 *

Amtrak Long Distance Bi-Level Fleet Replacement

Technical Specification

12. Door Systems

Revision 1

Table of Contents

12.1 Overview.....	12-1
12.2 General Requirements.....	12-1
12.3 Powered Side Entrance Doors.....	12-4
12.4 Manual Side Entrance Doors (Option)	12-20
12.5 Powered Carbody End Doors and Interior Passenger Area Doors.....	12-27
12.6 End of Train Door	12-35
12.7 Onboard Mobility Device Lift.....	12-36
12.8 Gap Filler.....	12-37
12.9 Passenger Room Entrance Doors (Sleeping Accommodations)	12-37
12.10 Automatic Sliding Restroom.....	12-41
12.11 Accessible Rooms	12-41
12.12 CDRLs.....	12-41

12.1 Overview

- a). The Amtrak Long Distance Fleet shall be equipped with electrically controlled power operated side entrance doors, passenger interior doors, carbody end doors, steps, gap fillers, and onboard mobility device lifts.
- b). The side entrance doors shall be designed to accommodate onboard mobility device lifts, gap fillers, and passenger boarding from low level (8" and 15") station platforms.
- c). The Contractor's design for the entire door system must comply with the latest requirements of 49 CFR Part 37, 49 CFR Part 38, 49 CFR Part 238, EN50155, APTA PR-CS-S-012-02, and APTA Standard PR-M-S-18-10.
- d). The door system shall operate over the entire range of operational, climatic, and track conditions identified in the Amtrak Specification 963. The door control relays, and associated panels shall meet Amtrak Specification 528.
 - i). Low level station platforms may be either below Top of Rail, at Top of Rail, 8 inches above Top of Rail and 61 inches from centerline of track, or 15 inches above Top of Rail and 64 inches from centerline of track.
 - ii). Many of the at or below TOR platforms are controlled by freight railroads who will protect their clearances. Careful consideration must be provided for these platforms as well.

12.2 General Requirements

- a). Design Objectives
 - i). Door systems have a demonstrated history of complexity and inconsistent performance that can affect the operation of passenger service and hinder maintenance and repairs. In order to maximize safety, system functionality and equipment availability, while minimizing the potential for degraded service or system performance, the side and end door systems shall be specified, designed and manufactured with an emphasis on addressing the following areas of concern:
 - (1) Unsafe conditions for passengers or crew members;
 - (2) Train delays from malfunctioning side door equipment;
 - (3) Poor system reliability in adverse operational and environmental conditions;
 - (4) Accumulation of dust and dirt that affects system performance and causes failures;
 - (5) System complexity that increases the time and effort required for troubleshooting and repairs; and
 - (6) Requirement for frequent adjustment and component replacement.

- ii). The door systems shall be designed with great attention to details so that it is safe, very reliable, requires little maintenance, is easy to service, has support parts available and will have a long service life.

b). Design Requirements

- i). The door system shall be designed and constructed so that no single point malfunction of door system components shall create an unsafe condition.
- ii). Door system failures shall be detectable through the following means:
 - (1) Failure to complete the door closed summary circuit and therefore prevent the locomotive from developing traction power (when a door panel is not fully closed and latched, or mechanically locked in the closed position and isolated electronically.
 - (2) Use of indicator lights that signal when a door is not confirmed closed and latched; and
 - (3) An indicator that signals when a door has been locked manually and isolated electrically
- iii). All controls, locks and latches, as well as door emergency access covers identified in this Chapter shall use the standard Amtrak coach key (coach key), per Amtrak Drawing B-144 (J.L. Howard Part No. 2555).
- iv). Environmental Considerations
 - (1) When closed, the doors shall provide a weatherproof seal under all car operating conditions.
 - (2) Neither drafts, nor air noises shall be detectable from the closed door over the full range of operating speeds of the vehicle, on all specified classes of track.
 - (3) The doors shall operate as specified over the entire range of all operational, climatic and track climatic conditions identified in Amtrak Specification 963.
 - (4) None of the electrical components, such as limit switches, shall be directly exposed to the weather, even with the door open.
 - (5) Climatic and environmental conditions, such as dust, snow or heat, shall not be a cause of door system failures.
- v). The door equipment mounting and internal fasteners shall be such that once adjustments are made and locked, they will not need to be re-adjusted until equipment overhaul or replacement.
- vi). Fasteners
 - (1) Fasteners shall be standard U.S. hardware.

- (2) Jam nuts, lock washers, nylock nuts or equivalent fasteners shall be used to secure door equipment.
- (3) Fastening aids, such as Loctite or equivalent products, shall not be permitted, unless specifically approved by Amtrak.
- vii). Maintainability
 - (1) All door mechanisms, including but not limited to tracks, operators, wiring to door panels, stops, limit switches and controls shall be accessible by opening hinged access panels on the inside of the car.
 - (2) No special tools will be required to open such panels, nor will any equipment have to be disconnected or removed to gain access.
 - (3) Access shall be provided from inside the car to all points necessary for inspection, service, installation or removal.
 - (4) All door system equipment shall be installed in such a manner so as to be:
 - (a) readily accessible to maintenance personnel with minimal effort
 - (b) readily available from the exposed side of the door operator
 - (c) able to be adjusted and maintained by a single person.
- viii). Interchangeability
 - (1) All door equipment of like function and the same hand shall be interchangeable without requiring modification.
 - (2) All component mounting holes for all door hardware shall be jig-drilled by the manufacturer.
 - (3) Mounting holes on the car shall also be jig- drilled.
 - (4) Door operators, door tracks and thresholds shall have their mounting positions controlled through suitable jigs/fixtures so as to ensure the correct physical relationship between carbody, door track, door pocket and operator.
 - (5) All door operators, tracks, hangers, linkages, brackets, obstruction sensing and electrical fittings shall be manufactured or supplied by one subcontractor.
- ix). Door panels shall be fully insulated against thermal and sound transmission and grounded per APTA Standard SS-E-005-98.
- x). A Portable Test Unit connection and software will be provided to aid in troubleshooting and provide system diagnostics.

- xi). Door controllers shall report alerts and fault information to the car diagnostic system.

12.3 Powered Side Entrance Doors

a). General

- i). Trainline-controlled, power operated stainless steel side entrance plug or pocket doors shall be provided for each car type.
- ii). Side entrance doors shall be installed at the approximate midpoint of each side of the car.
- iii). A door control panel shall be installed adjacent to each exterior side door and shall have both local door and trainline controls.
- iv). Side entrance doors shall provide an opening width of at least 36".
- v). A weatherproof coach key switch, complete with seal over key opening and detent latch, shall be provided adjacent to the side doors on each side of all cars to allow crew to open or close the adjacent door leaves to enter or exit the car.
- vi). Each car shall be equipped with two (2) inside body end doors located on the upper level.
- vii). Interlock shall be provided with the car-borne wheelchair lifts that prevent the doors from closing when the wheelchair lift is deployed at that door opening.
- viii). A minimum number of door panel types shall be used for each car type.
- ix). Hand-operated latches and handles shall provide clearance for operation by a gloved hand.
- x). All doors shall be solidly mounted, of lightweight construction, vibration free, open or close positively, and not rattle or make noise in service.
- xi). It is preferred that the design of the exterior doors of each car type shall be a flat panel, where possible. The panel shall meet the materials and workmanship requirements and shall have fully interchangeable components.

b). Side Door Controls and Operation

- i). The side door controls for each car type shall include the following features:
 - (1) Trainline control at 74 Volts Direct Current (VDC) via 27-point communication trainline cable, in compliance with Amtrak Drawing A-63-7676-1.
 - (2) The side doors shall be operated from a local door control panel or via trainline OPEN or CLOSE commands from another location or train.

- (3) Side doors shall not prohibit egress in an emergency situation or in the event of HEP power loss or air loss.
- (4) A local maintenance on/off switch shall be provided per doorway to de-energize the local door circuits and motor during maintenance and/or troubleshooting.
- (5) Interchangeability
 - (a) The DCU shall automatically detect the car type and location in which it is installed.
 - (b) The door system software shall be unified throughout all DCUs, so no additional manual configuration is needed when it is installed/replaced.
- (6) Relay-based logic and discrete trainlines shall be provided for the issuing of control commands to the doors.
- (7) Discrete trainlines shall also be used to monitor the door closed and locked status of all doors in the train, and for providing the required indications to the train crew.
- (8) Safety Considerations
 - (a) The door control system shall incorporate logic that shall meet the requirements of EN 50126 SIL 3 so that no unsafe condition will be created:
 - (i) through normal operation of the door system, or
 - (ii) due to a failure of door system equipment or components.
 - (b) Door control system shall be able to tolerate two separate grounds anywhere in the train in the door circuits and not have an unintended door opening.
 - (c) Control system design shall be fault tolerant to prevent unintended door openings.
- (9) Each door leaf shall be provided with a position sensor to detect that the door is fully closed and that it is mechanically latched.
- (10) Zero Speed Protection
 - (a) The zero-speed protection from wheel slide control unit on each car shall include all of the following:
 - (i) Door control panel system deactivation if not at zero-speed.
 - (ii) Removal of power from door operator's door OPEN function if not at zero speed.

- (iii) Door CLOSE command automatically issued in both directions on left and right door close trainlines when car motion is detected.
 - (b) Zero-speed signal supplied by the wheel slide control unit shall be required in order to issue an OPEN command to the side doors.
 - (i) Conversely, the absence of a zero speed signal shall prohibit the issuance of an OPEN command to the side doors.
 - (11) Traction Interlock
 - (a) Traction interlock shall be provided, with door closed indication, that prevents the locomotive from developing tractive effort if any side door is not fully closed and latched, or mechanically locked and electrically isolated.
 - (i) There is no interlock between the door closed summary circuit and the brake system.
 - (12) Obstruction detection on each door leaf meeting the requirements of APTA Standard SS-M-18-10.
 - (13) Emergency Releases
 - (a) Manual emergency release for each door leaf from inside the car, with frangible cover.
 - (b) Exterior emergency release for each door leaf, fully enclosed behind a weatherproof cover.
 - (14) Mechanical lock which can be engaged manually with a coach key from inside the car which allows the on-board crew to secure the door leaf closed and isolate the door operator electrically.
 - (15) All door control system signal and indicator lights shall use approved long life, high intensity Light Emitting Diode (LED) or LED arrays lamps having a rated life of at least 100,000 hours.
 - (16) Audible signal, on or near the door header at each side door opening at the same rate as the blue ADA indicator light.
 - (a) Tone and volume of audible signal to be submitted to the Amtrak for approval during design review. **[CDRL 12-01]**
- c). Side Door Operator and Linkage
- i). General
 - (1) The side doors shall employ electric, electro-pneumatic or linear-induction operators, one per door leaf.

- (2) Doors shall be operated from the nominal 74VDC car battery system but shall operate normally over the full voltage range from normal Head End Power (HEP).
 - (a) The motor and controls shall reliably be compliant to EN50155, and shall operate without damage and without affecting the reliability and serviceable life of the operator.
 - (b) The Contractor shall provide an engineering analysis to verify door operators will operate over this voltage range without damage to components **[CDRL 12-02]**.
- ii). Locking Mechanism
 - (1) The operator shall include an over-center or equivalent locking mechanism so that a door which is closed will remain closed and latched upon loss of electrical or pneumatic power, regardless of car vibration.
 - (2) The door operators shall include a local mechanical cutout which allows the on-board crew to deactivate and isolate a door operator by locking the door.
- iii). Opening and Closing Forces
 - (1) The drive mechanism shall be designed to minimize torque applied to door panels during operation.
 - (2) The operator and linkage for each panel shall be arranged so the maximum force required to manually move a door panel shall not exceed 30 pounds of force (lbf) at mid-point of travel.
 - (3) The doors shall open or close successfully with no greater than a 60 lbf applied perpendicular to the interior door surface at a height of 56 in. above the floor, throughout the entire opening cycle, and through the closing cycle until 5 in. before the fully closed position.
- iv). Dampening and Door Motion
 - (1) The door motion shall be smooth and free of shock and impact.
 - (2) The door operator shall decelerate the door leaves at each extremity, to preclude slamming or rebound, and bring them to rest gently at the extremity of door leaf travel.
 - (3) Damping shall be provided at the ends of travel of the door panel in both the opening and closing directions.
 - (4) The door operator motion shall be smooth and free of shock and impact and shall be capable of holding the door, without oscillation, in either an open or closed position with the car on all configurations of track as specified in Amtrak Specification 963.

- (5) Door leaf travel shall be easily adjustable, with provisions, to set open and close positions.
- v). Limit Switches and Proximity Sensors
 - (1) All limit switches and proximity sensors used in the operator shall be hermetically sealed and shall be easily replaceable.
 - (2) All limit switches and proximity sensors shall be precision units that are positively and precisely located so they may be replaced without the need for mechanism adjustment.
- vi). Opening and Closing Times
 - (1) Door opening and closing times shall be independently adjustable and shall be initially set at:
 - (a) Opening: 3 (\pm 0.5) seconds
 - (b) Closing: 3 (\pm 0.5) seconds
 - (2) If sliding plug doors are used, the operating timing shall be defined as follows:
 - (a) Opening: 4.0 seconds – Adjustable 4.0 to 8.0 (\pm 0.5) seconds
 - (b) Closing: 4.0 seconds – Adjustable 4.0 to 8.0 (\pm 0.5) seconds
 - (3) The opening and closing values shall be independently adjustable by the Portable Test Unit.
- vii). Protection from Damage
 - (1) Operator design shall be such that a mechanical or electrical failure shall not result in subsequent damage to other equipment.
 - (2) The door motor shall be suitably protected from the surrounding environment and be of a sealed design.
- viii). Interchangeability
 - (1) All door operator motors shall be interchangeable from one door position to another, or between all doors of the same hand (right-hand and left-hand).
- d). Side Door Panel Construction
 - i). The side entrance door panel shall be constructed of stainless steel with a honeycomb core.
 - ii). Doors shall be of an adequate thickness for the intended service, which means they shall be resistant to damage from impacts with roadside debris

- such as rocks, as well as resist being bent from misuse, attempted operation with the door stuck, or a mechanical malfunction.
- iii). In addition, when supported at both ends, the door leaf shall sustain a concentrated load of 250 lbs applied at the center of the front face, over an area of 4 in², at 90° to the plane of the panel, without deflecting more than 0.25 in., nor shall the panel take a permanent set.
 - iv). All door panel joints and edges shall be sealed against moisture.
 - v). Stainless steel reinforcements shall be provided at attachment points.
 - vi). Structure used to secure the door leaf to the door hanger shall last the life of the car, without fatigue cracks or similar failure, even if the door operator malfunctions and slams the door leaf repeatedly.
 - vii). Epoxy used in door panel construction shall be waterproof.
 - viii). All internal door leaf wiring and sensitive edge shall be run through internally routed conduit.
 - ix). The exterior surface of the door panel shall match that of the exterior of the car body.
 - x). The sensitive edge and door mounted weather seals shall be part of the door panel assembly.
 - xi). Door panels shall be insulated against thermal and sound transmission.
 - xii). Door panels shall be welded in accordance with all applicable AWS requirements.
- e). Door Panel Windows
- i). Each door panel shall have window openings formed to accept FRA Part 223 compliant glazing.
 - ii). The door window frame shall be an integral part of the door structure and shall be capable of retaining the window in the door opening when subjected to the impact applicable to the window location described in 49CFR Part 223.
 - iii). The window and its glazing shall not extend beyond the outer surface of the door.
 - iv). All door windows shall be retained in the door frame by use of a rubber extrusion and zip strip combination which will allow installation/removal of the glazing from inside of the door.
 - v). The side door windows must be openable on a hinge, hinged on the same side as the door it is on and able to be retained in the fully open position.
 - (1) The window shall be 2 feet wide by 3 feet high.

- (2) The side door window shall have a switch interlocked with the window to ensure that the side door open command is not initiated unless the window is closed.
- f). Side Door Obstruction Detection
 - i). Each door leaf shall be equipped with an obstruction detection system.
 - ii). Should the door close against an obstruction, the obstruction detection system shall immediately initiate the door opening cycle.
 - iii). The force required to activate the system shall not exceed 20 lbf.
 - iv). The sensitivity of the obstruction detection system shall conform to APTA Standard SS-M-18-10.
 - v). The design of the obstruction detection system shall not allow the door to oscillate if no obstruction is present.
 - vi). The doors shall not close and latch to permit a closed-door indication if an obstruction is detected.
 - vii). Deflection of the sensitive edge shall have no effect on the door control system after the door has closed and locked.
 - viii). Soft elastomer edges shall be designed to permit the withdrawal of an obstruction that could be undetected between a closed side door and its mating edge
 - ix). The design of the obstruction detection system shall be subject to Amtrak approval during design review.
 - x). The Contractor shall provide a detailed assessment of the obstruction detection system as proposed, including theory of system operation, proven service history, reliability and maintainability, compliance with applicable regulations and standards, and safety analysis.
- g). Overhead Door Track
 - i). Door leaves shall be suspended from an overhead door track.
 - ii). The track and door hanger assembly shall have minimum service life of 25 years.
 - iii). The door track/hanger shall not require lubrication over its life.
 - iv). The load bearing surface of the door track shall be convex, so as to be self-cleaning from buildup of dust.
 - v). The door track shall employ rollers with sealed, permanently lubricated bearings or other roller design that does not require lubrication.

- vi). The overhead door track and rollers shall not be affected by environmental conditions, including the accumulation of dust.
 - vii). The door hanger and door track shall be able to resist, without damage or permanent deformation, a force of 200 lbf applied perpendicularly at the center of the door panel, both in inward and outward directions.
 - viii). The rollers shall be secured to the hanger assembly with a mechanism, both to adjust for level as well as control vertical free-play between the hanger assembly and door track.
 - ix). Door leaf adjustment shall allow the space between the nosing seal to be made constant from the top to the bottom of the leaf.
 - x). The amount of track-to-roller free-play shall prevent the trailing edge roller from lifting on the track if the door leaf strikes an obstruction down low while closing.
 - xi). Adjustment of free-play clearances shall be easily done using standard tools.
 - xii). The track itself and mounting to carbody (not the door-to-hanger connection) shall be adjustable to accommodate both carbody and door leaf tolerances, including both height and plumb.
 - xiii). Sliding plug doors with linear bearings may be used, provided that the linear bearings are of a service proven design and do not require lubrication more frequently than annually.
- h). Bottom Door Guides and Thresholds
- i). A door guide with corresponding threshold shall be provided at the bottom of the door.
 - ii). Adjustable wear strips, if provided, shall be easily replaceable without removing or readjusting the door panel.
 - iii). The bottom guide arrangement shall be designed not to collect dirt and debris and to ensure a low friction operation with no binding or rattling.
 - iv). The thresholds shall be compliant with ADA requirements.
 - v). The door guide/threshold shall form part of the door weather seal and shall incorporate drain holes to carry off water to the underside of the car.
 - vi). The threshold and drain and their sealing to the carbody shall ensure that water or other fluids do not seep underneath and cause deterioration of flooring, its substructure or insulation.
 - vii). Easy access shall be provided to the door guide/threshold for cleaning and maintenance.
 - viii). The guide shall be adjustable to accommodate both carbody and door leaf tolerances.

- ix). Any part of the door guide system subject to wear shall be easily replaceable without removing the door panels.
- i). Freeze Protection
 - i). Freeze protection system shall be provided at each side entrance door and shall be with sufficient capacity to prevent ice formation in the door pockets, bottom door guide and thresholds, vestibule steps, and gap filler.
 - ii). All heaters shall be 120 VAC and shall be activated by the car freeze protection circuit at ambient temperatures of 40 degrees F or below.
 - iii). The design of the system shall be included in the door system design review and shall be subject to Amtrak design review and approval.
 - iv). An ice breaker feature, which enables the system motor to increase power to break ice that prevents the smooth slide out of the gap filler shall be included.
 - v). The ice breaker feature shall activate automatically if temperatures are below a pre-defined level and if the gap filler has failed to open three times.
 - vi). The ice breaker temperature signal shall be taken from the HVAC system control.
- j). Weather Seal
 - i). Amtrak will operate the cars at 110 mph throughout the continental United States.
 - ii). The very high operating speeds of the cars combined with frequent winter exposure to snow, freezing rain and ice, as well as heavy rain conditions, makes it of extreme importance that exceptionally high levels of weather sealing be applied to the door systems.
 - (1) The leading edge of the door panel shall interlock with the adjacent door panel (if present) to form a weatherproof seal.
 - (2) The door opening, including the interior and exterior sides and top, shall be equipped with a flexible weather seal.
 - (3) The rear edge of the leaf shall be equipped with a batten that positively engages the door seal when the door is fully closed, including the radius at the top of the door opening.
 - (4) This combination shall create a dust and weatherproof seal (see Chapter 20 for test requirements).
 - iii). The seal shall be attached to the door frame with sufficient clearance so as to prevent chafing against the leaf as it moves, yet ensure every door leaf seals on every car, despite the combination of all manufacturing tolerances.
 - iv). The top of the opening shall also be equipped with a weather seal.

- v). The interface between the bottom of the door and the threshold shall form a weather seal.
 - vi). Seal design shall also limit the entrance of dust and snow into the door pocket when the door is open.
 - vii). Adjustments to keep the seal system weather tight shall not be required more often than annually.
- k). Emergency Releases
- i). Manual interior and exterior emergency releases shall be provided to allow each side door panel to be opened manually in emergency situations.
 - ii). The emergency release handle shall be red and be simple for individuals to understand and operate.
 - iii). Activating the emergency release handle shall: remove power from the door motor, release the door mechanical lock (if locked) and disengage the door over-center locking mechanism and separate the door panels by at least one inch so that the door leaf may be manually opened.
 - iv). Using the emergency release, the force to disengage the door operator and to move the door leaf shall not exceed 30 lbf external per APTA Standard SS-C&S-012-02.
 - v). The exterior emergency release handle shall be located on the car side, near the door it releases, behind a weatherproof cover.
 - vi). At least one release shall be provided for each door opening that permits the opening of both door leaves.
 - vii). The cover shall allow access in an emergency and be able to be sealed and locked for securing car when not occupied.
 - viii). Operating instructions shall be provided on or near the cover.
 - ix). An interior emergency release handle shall be located adjacent to each door leaf, behind an easily replaceable, transparent frangible weatherproof cover.
 - x). To allow crew access to the release emergency release without breaking the frangible material, such as when the car has no power, the cover frame shall be hinged and equipped with a coach key release.
 - xi). Opening the frame will also allow the frangible material to be easily replaced.
 - xii). The inside handle, once actuated, shall remain in the actuated position.
 - xiii). Operating instructions for the emergency door release mechanism shall be installed near the emergency release, per the location and illumination requirements of 49CFR Part 238.

- xiv). It shall be possible for emergency personnel to manually open the side doors from outside the car with the car resting on its side, by using only tools normally carried by such personnel.
 - xv). This shall be demonstrated with an exterior door and frame assembly in the horizontal position, using actual production components.
 - xvi). It shall be assumed that no damage exists to the door, door frame or operating mechanism.
 - xvii). If a cable system is employed between the external release handle and door operator, it shall be run within a conduit to allow it to be replaced easily, without major car disassembly.
 - xviii). Appropriate labels shall be provided with operating instructions at convenient locations, consistent with APTA Standard SS-PS-002-98.
- l). Door Control Panel
- i). A stainless steel watertight door control panel shall be provided for the train crew to control all the side doors on its respective side of the train.
 - ii). The control panel shall be activated with a coach key, with the key removable only in the OFF position.
 - iii). Indicator lights on the panel shall employ socket-mounted LED technology.
 - iv). A button shall be provided at the door control panel for the Conductor's signal buzzer.
 - v). In addition to trainline operation, the side doors shall be equipped with a trainline/local coach key switch panel which allows the crew to select whether an adjacent door will open in response to trainline OPEN commands, or only on a local basis.
 - vi). Positions shall be labeled TRAINLINE/LOCAL (9 o'clock position) and LOCAL ONLY (6 o'clock position).
 - (1) The coach key shall be removable from either position.
 - vii). With the switch in the LOCAL ONLY position, the connection from the door open trainline is interrupted, so that the affected doors only open upon an OPEN command from the door control panel-local or the crew access switch adjacent to those doors and shall not open in response to a trainline OPEN command from another door control panel.
 - viii). When in the TRAINLINE/LOCAL position, the side doors at this location shall open either upon a trainline OPEN command from another door control panel, or from the adjacent door control panel-local or exterior crew access switch.
 - ix). In either position, the doors will close upon a CLOSE command from the door control panel-local, or from a trainline CLOSE command.

- m). Crew Key Switches
 - i). The crew switch shall be three-position, spring return to center, with key capture in open and closed positions on the exterior of the car.
 - ii). The crew switches shall not be connected in parallel and shall have separate inputs to the DCU so lower and upper crew switches can be configured independently.
 - iii). Rotating the key to the left shall open the doors, and to the right shall close the doors.
 - iv). The crew key switch shall be arranged so that when the key is removed, the door shall remain in the last position commanded.
 - v). Trainline commands shall take precedence over local commands.
 - vi). If a door is opened with the local crew key switch, it shall be possible to close it by trainline control.
 - vii). Switches within the assembly shall be weatherproof.
- n). Door Cutout and Mechanical Lock
 - i). A positive mechanical lock function shall be provided for each passenger side door leaf, or pair of side door leaves if door operation uses synchronized door panels, to deactivate power from that door operator and to secure the leaf in the fully closed position.
 - ii). This lock shall be operated from inside the car only, by a coach key. The door closed and lock loop shall only be bypassed when the door leaf is fully closed, and the mechanical lock fully engaged.
 - iii). The emergency release function shall still be available for a locked out door, but if the release is used, the door panel locked sensing function shall be reactivated.
 - iv). If the emergency release has been activated while the mechanical lock was in the locked out position, the design of the keeper shall allow the lock bolt to re-engage automatically when the door leaf is again closed (so as to not ram the edge of the keeper with the bolt).
 - v). Engagement of the lock bolt shall be sufficient to provide positive panel locking under all conditions.
 - vi). It shall not be possible to withdraw the key unless the lock bolt is fully engaged or fully unlocked.
- o). Door Status Indicators and Alarms
 - i). Audible and visual warnings that comply with the requirements of 49CFR Parts 37 and 38 shall be provided at each doorway and shall be activated prior to door closing.

- ii). Activation of the warnings shall precede the initiation of door closing by approximately 3 seconds.
- iii). The warnings shall alert passengers inside and outside the car on the side of the car at which the doors are open.
- iv). Exterior Door Open Indicators
 - (1) A red exterior LED type door open indication shall be provided on each side of the car at each entrance doorway (see Chapter 11).
 - (2) Both lights adjacent to an individual vestibule (one on each side of the car) shall be extinguished when all doors at that entrance vestibule (both sides of car) are closed and locked.
 - (3) The indicators shall be bright and visible at a distance of 1870 ft, on tangent track, bright enough to be visible in bright direct sunlight and shall be visible to crewmembers in vestibules and in the operating cabs of locomotives when looking down the side of the train from either direction.
- v). Exterior Accessibility Indicators
 - (1) A blue Accessibility LED indicator shall be provided outside each passenger side entrance door that contains an onboard mobility device.
 - (2) The Accessibility indicators shall be triggered via the door controls to provide a flashing indication at 1 Hz while the doors at that location are open and shall flash at 2 Hz from the time that a CLOSE command is issued to those doors until the doors are closed and locked (see Chapter 14).
- vi). Interior ADA Door Closing Indicators and Alarms
 - (1) To warn hearing impaired passengers that the doors are about to close, red LED interior door closing warning lights shall be provided in the door header at each side entrance door.
 - (a) These lights shall be triggered via the door controls to provide a flashing indication, upon initiation of the door "close" command, and continue to flash until the door begins to close.
 - (b) The flashing rate of the indicator shall be approximately 2.0 Hz.
 - (2) To warn passengers that the doors are about to close, an interior door closing warning audio alarm shall be provided in the door header at each side entrance door.
 - (a) The door closing warning audio alarms shall be triggered by the door controls.

- (b) The door closing warning alarm shall start to sound upon the initiation of the door CLOSE command and continue to sound until the door begins to close,
 - (c) The audio alarm shall be pulsing audio shall develop a sound level of 88 +/-2 decibels (dB) at 5 ft 6 in. above the center of the door threshold, with a frequency of 3000 Hz.
 - (3) An interior door closing interlock with Public Address (PA) system to initiate "doors closing" message shall be provided. See Chapter 14.
 - (4) When the door closed trainline is activated, a 3 second warning of the above visual and audio devices will be given at each entrance area before the doors begin to close.
- vii). Interior Door Status Indicators
 - (1) Each door leaf shall be equipped with a yellow LED indicator light mounted in the ceiling panel over each door leaf. This indicator shall display the status of the door leaf:
 - (a) On continuously: Door leaf is open or is not confirmed closed and latched.
 - (b) Flashing (1 Hz): Door leaf is locked manually with the mortise lock and isolated from the door control circuit and the door closed summary circuit.
 - (c) Off: Door panel is confirmed closed and latched, but not locked with the mortise lock.
- p). Design Safety Validation
 - i). The Contractor shall conduct a hazard analysis and a Failure Mode and Effects Criticality Analysis (FMECA) for hardware and a Fault Tree Analysis (FTA) for the entire side door system as necessary to demonstrate that the safety requirements of the system are met under all operating conditions.
 - ii). This analysis shall be performed for an individual car of each type and for a train consisting of cars from the same build lot. This shall include:
 - (1) logic,
 - (2) interlocks,
 - (3) mechanical mechanisms,
 - (4) indicators,
 - (5) bypasses,
 - (6) cutouts and

- (7) controls.
- iii). The analysis shall be submitted to Amtrak **[CDRL 12-03]** for review and acceptance as part of the Design Review process.
- q). Door Pocket
 - i). If pocket doors are provided, the door pocket will accommodate the door leaf while the door is open.
 - ii). The bottom of the door pocket shall be lined with corrosion resistant material to prevent deterioration of car structure and flooring.
 - iii). The bottom of the door pocket shall also incorporate a pan designed to drain water out of the pocket area through a tube to the underside of the car.
 - iv). The drain shall be easily accessible for cleaning and shall be equipped with a backflow preventer to keep dust and moisture from blowing into the pocket.
 - v). It shall be designed to ensure that water does not seep underneath and cause deterioration of flooring, its substructure or insulation.
- r). Door Markings
 - i). Door positions shall be numbered in accordance with **Figure 12-1**.
 - ii). In addition, each door shall be labeled for emergency egress in accordance with APTA Standard SS-PS-002-98, Rev. 2.
 - iii). Signage shall be installed on each door leaf that describes the procedure for opening the doors in the event of an emergency.
 - iv). This signage shall conform to the requirements of APTA Standard SS-PS-002-98 and 49CFR Part 238.
 - v). Signage shall also be provided above each door leaf or pair of door leaves, adjacent to the yellow door status LED indicator, that states that the door leaf is inoperative or out of service when the yellow light is flashing.
 - vi). A sign shall be installed on the exterior of the A-end vestibule doors on the café/lounge car that states NO PASSENGER ENTRANCE.
 - vii). The proposed artwork, material, color, size, location and adhesive for these signs shall be submitted for Amtrak approval during the design review process. **[CDRL 12-4]**

Upper and Lower Level Access

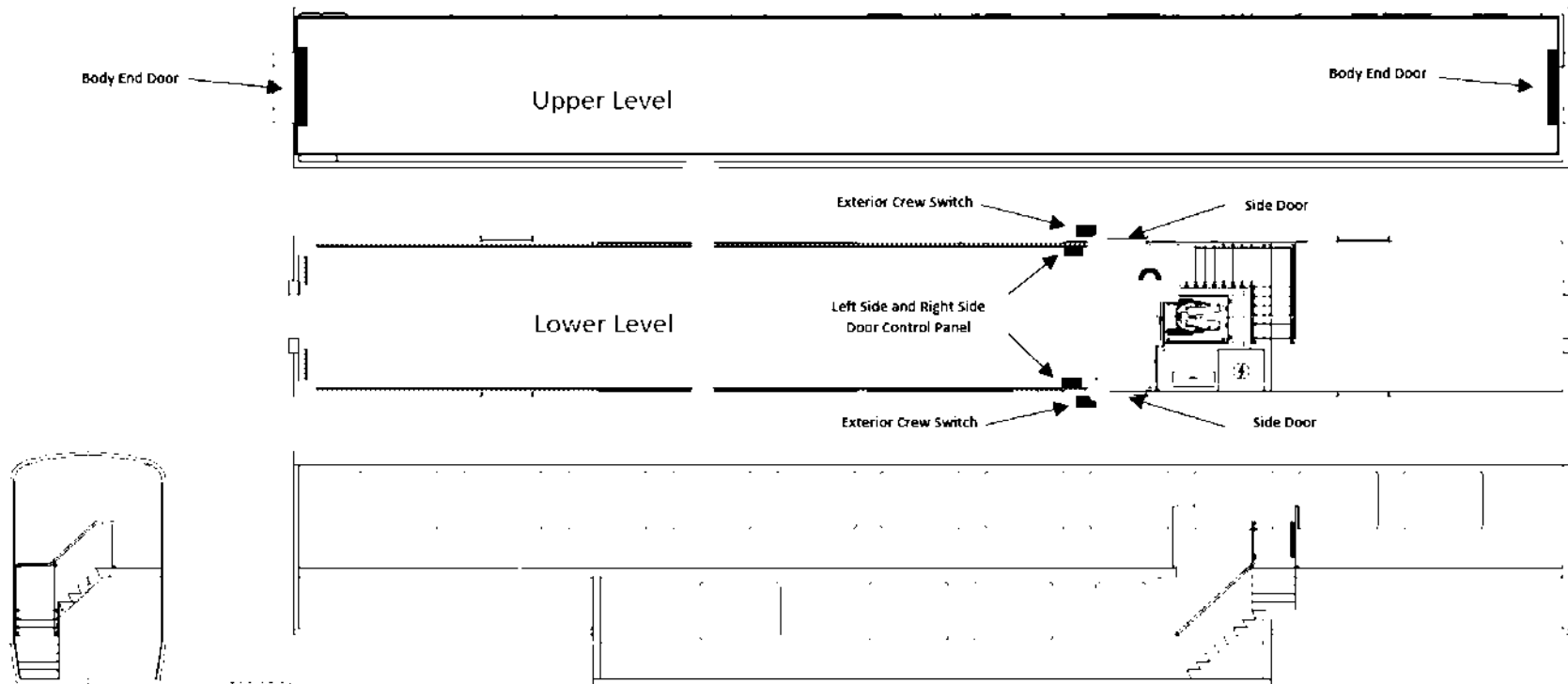

Figure 12-1: Door Positions

12.4 Manual Side Entrance Doors (Option)

a). General

- i). As an option, the Contractor shall propose manually operated, hinged side entrance doors.
- ii). Manual swing doors made of stainless steel with openable windows in the upper portion shall be provided for each car type.
- iii). Side entrance doors shall provide an opening width of at least 36".
- iv). A weatherproof coach key switch, complete with seal over key opening and detent latch, shall be provided adjacent to the side doors on each side of all cars to allow crew to open or close the adjacent door to enter or exit the car.
- v). A minimum number of door panel types shall be used for each car type.
- vi). Door swing into vestibule of at least 90 degrees.
- vii). Rotating, hand-operated latches and handles shall provide clearance for operation by a gloved hand.
- viii). Slam latch on interior wall to secure door in open position.
- ix). Two dog latches, mounted on door panel, with detent-type keeper on door frame. Dog handles rotated approximately 90 degrees and equipped with stops so with dogs unlatched, they stay in the open position naturally and don't swing closed by themselves, nor foul the door opening.
 - (1) The force to operate the dog latches shall be 15 lbf or less.
- x). All doors shall be solidly mounted, of lightweight construction, vibration free, open or close positively, and not rattle or make noise in service.
- xi). It is preferred that the design of the exterior doors of each car type shall be a flat panel, where possible. The panel shall meet the materials and workmanship requirements and shall have fully interchangeable components.

b). Manual Side Entrance Door Controls and Operation

- i). Each door shall be provided with a position sensor to detect that the door is fully closed and that it is mechanically latched.
- ii). Zero Speed Protection
 - (1) The zero-speed protection from wheel slide control unit on each car shall include all of the following:
 - (a) Door control panel system deactivation if not at zero-speed.
 - (b) Removal of function to open door if not at zero speed.

- (2) Zero-speed signal supplied by the wheel slide control unit shall be required in order to open the side doors.
 - (a) Conversely, the absence of a zero speed signal shall prohibit the ability to open the side doors.
 - iii). Traction Interlock
 - (1) Traction interlock shall be provided, with door closed indication, that prevents the locomotive from developing tractive effort if any side door is not fully closed and latched, or mechanically locked and electrically isolated.
 - (a) There is no interlock between the door closed summary circuit and the brake system.
 - iv). Emergency Releases
 - (1) Manual emergency release for each door from inside the car, with frangible cover.
 - (2) Exterior emergency release for each door, fully enclosed behind a weatherproof cover.
 - v). Mechanical lock which can be engaged manually with a coach key from inside the car which allows the on-board crew to secure the door closed and isolate the door operator electrically.
 - vi). All door control system signal and indicator lights shall use approved long life, high intensity Light Emitting Diode (LED) or LED arrays lamps having a rated life of at least 100,000 hours.
- c). Manual Side Entrance Door Panel Construction
- i). The side entrance door panel shall be constructed of stainless steel with a honeycomb core.
 - ii). Doors shall be of an adequate thickness for the intended service, which means they shall be resistant to damage from impacts with roadside debris such as rocks, as well as resist being bent from misuse, attempted operation with the door stuck, or a mechanical malfunction.
 - iii). In addition, when supported at both ends, the door leaf shall sustain a concentrated load of 250 lbs applied at the center of the front face, over an area of 4 in², at 90° to the plane of the panel, without deflecting more than 0.25 in., nor shall the panel take a permanent set.
 - iv). All door panel joints and edges shall be sealed against moisture.
 - v). Stainless steel reinforcements shall be provided at attachment points.
 - vi). Structure used to secure the door to the door frame shall last the life of the car, without fatigue cracks or similar failure.

- vii). Epoxy used in door panel construction shall be waterproof.
 - viii). All internal door wiring shall be run through internally routed conduit.
 - ix). The exterior surface of the door panel shall match that of the exterior of the car body.
 - x). The door mounted weather seals shall be part of the door panel assembly to produce a watertight seal.
 - xi). Door panels shall be insulated against thermal and sound transmission.
 - xii). Door panels shall be welded in accordance with all applicable AWS requirements.
- d). Door Panel Windows
- i). Each door panel shall have window openings formed to accept FRA Part 223 compliant glazing.
 - ii). The door window frame shall be an integral part of the door structure and shall be capable of retaining the window in the door opening when subjected to the impact applicable to the window location described in 49CFR Part 223.
 - iii). The window and its glazing shall not extend beyond the outer surface of the door.
 - iv). All door windows shall be retained in the door frame by use of a rubber extrusion and zip strip combination which will allow installation/removal of the glazing from inside of the door.
 - v). The side door windows must be openable on a hinge, hinged on the same side as the door it is on, opening into the interior of the car and able to be retained in the fully open position.
 - (1) The window shall be 2 feet wide by 3 feet high.
- e). Bottom Door Guides and Thresholds
- i). A door guide with corresponding threshold shall be provided at the bottom of the door.
 - ii). Adjustable wear strips, if provided, shall be easily replaceable without removing or readjusting the door panel.
 - iii). The bottom guide arrangement shall be designed not to collect dirt and debris and to ensure a low friction operation with no binding or rattling.
 - iv). The thresholds shall be compliant with ADA requirements.
 - v). The door threshold shall form part of the door weather seal and shall incorporate drain holes to carry off water to the underside of the car.

- vi). The threshold and drain and their sealing to the carbody shall ensure that water or other fluids do not seep underneath and cause deterioration of flooring, its substructure or insulation.
 - vii). Easy access shall be provided to the door threshold for cleaning and maintenance.
 - viii). A bottom wear strip shall be designed that is robust to the environment and to a hinged door application.
- f). Freeze Protection
- i). Freeze protection system shall be provided at each side entrance door and shall be with sufficient capacity to prevent ice formation in the door pockets, thresholds, vestibule steps, and gap filler.
 - ii). All heaters shall be 120 VAC and shall be activated by the car freeze protection circuit at ambient temperatures of 40 degrees F or below.
 - iii). The design of the system shall be included in the door system design review and shall be subject to Amtrak design review and approval.
- g). Weather Seal
- i). Amtrak will operate the cars at 110 mph throughout the continental United States.
 - ii). The very high operating speeds of the cars combined with frequent winter exposure to snow, freezing rain and ice, as well as heavy rain conditions, makes it of extreme importance that exceptionally high levels of weather sealing be applied to the door systems.
 - (1) The door opening, including the interior and exterior sides and top, shall be equipped with a flexible weather seal.
 - (2) This combination shall create a dust and weatherproof seal (see Chapter 20 for test requirements).
 - iii). The top of the opening shall also be equipped with a weather seal.
 - iv). The interface of the door edges and the threshold shall form a weather seal.
 - v). Seal design shall also eliminate the entrance of dust, sand, and snow into the door pocket when the door is open.
 - vi). Adjustments to keep the seal system weather tight shall not be required during the life of the seal, which shall be no less than 8 years.
- h). Emergency Releases
- i). Manual interior and exterior emergency releases shall be provided to allow each side door panel to be opened manually in emergency situations.

- ii). The emergency release handle shall be red and be simple for individuals to understand and operate.
 - iii). Activating the emergency release handle shall: release the door mechanical lock.
 - iv). The exterior emergency release handle shall be located on the car side, near the door it releases, behind a weatherproof cover.
 - v). The cover shall allow access in an emergency and be able to be sealed and locked for securing car when not occupied.
 - vi). Operating instructions shall be provided on or near the cover.
 - vii). An interior emergency release handle shall be located adjacent to each door, behind an easily replaceable, transparent frangible weatherproof cover.
 - viii). To allow crew access to the emergency release without breaking the frangible material, such as when the car has no power, the cover frame shall be hinged and equipped with a coach key release.
 - ix). Opening the frame will also allow the frangible material to be easily replaced.
 - x). The inside handle, once actuated, shall remain in the actuated position.
 - xi). Operating instructions for the emergency door release mechanism shall be installed near the emergency release, per the location and illumination requirements of 49CFR Part 238.
 - xii). It shall be possible for emergency personnel to manually open the side doors from outside the car with the car resting on its side, by using only tools normally carried by such personnel.
 - xiii). This shall be demonstrated with an exterior door and frame assembly in the horizontal position, using actual production components.
 - xiv). It shall be assumed that no damage exists to the door, door frame or operating mechanism.
 - xv). If a cable system is employed between the external release handle and door operator, it shall be run within a conduit to allow it to be replaced easily, without major car disassembly.
 - xvi). Appropriate labels shall be provided with operating instructions at convenient locations, consistent with APTA Standard SS-PS-002-98.
- i). Crew Key Switches
- i). The crew switch shall be three-position, spring return to center, with key capture in open and closed positions on the exterior of the car.

- ii). The crew switches shall not be connected in parallel and shall have separate inputs to the DCU so lower and upper crew switches can be configured independently.
- iii). Rotating the key to the left shall allow the doors to unlock, and to the right shall lock the doors.
- iv). Switches within the assembly shall be weatherproof.
- j). Door Cutout and Mechanical Lock
 - i). A positive mechanical lock function shall be provided for each manual side entrance door in the event that a zero speed signal is not provided from the door.
 - ii). This lock shall be operated from inside the car only, by a coach key. The door closed and lock loop shall only be bypassed when the door is fully closed, and the mechanical lock fully engaged.
 - iii). The emergency release function shall still be available for a locked out door, but if the release is used, the door panel locked sensing function shall be reactivated.
 - iv). If the emergency release has been activated while the mechanical lock was in the locked out position, the design of the keeper shall allow the lock bolt to re-engage automatically when the door is again closed (so as to not ram the edge of the keeper with the bolt).
 - v). Engagement of the lock bolt shall be sufficient to provide positive panel locking under all conditions.
 - vi). It shall not be possible to withdraw the key unless the lock bolt is fully engaged or fully unlocked.
- k). Door Status Indicators and Alarms
 - i). Exterior Door Open Indicators
 - (1) A red exterior LED type door open indication shall be provided on each side of the car at each entrance doorway (see Chapter 11).
 - (2) Both lights adjacent to an individual vestibule (one on each side of the car) shall be extinguished when all doors at that entrance vestibule (both sides of car) are closed and locked.
 - (3) The indicators shall be bright and visible at a distance of 1870 ft, on tangent track, bright enough to be visible in bright direct sunlight and shall be visible to crewmembers in vestibules and in the operating cabs of locomotives when looking down the side of the train from either direction.
 - ii). Exterior Accessibility Indicators

- (1) A blue Accessibility LED indicator shall be provided outside each passenger side entrance door that contains an onboard mobility device.
 - (2) The Accessibility indicators shall be triggered via the door controls to provide a flashing indication at 1 Hz while the doors at that location are open and shall flash at 2 Hz from the time that a CLOSE command is issued to those doors until the doors are closed and locked (see Chapter 14).
- iii). Interior Door Status Indicators
- (1) Each door leaf shall be equipped with a yellow LED indicator light mounted in the ceiling panel over each door leaf. This indicator shall display the status of the door leaf:
 - (a) On continuously: Door is open or is not confirmed closed and latched.
 - (b) Flashing (1 Hz): Door is locked manually with the mortise lock and isolated from the door control circuit and the door closed summary circuit.
 - (c) Off: Door is confirmed closed and latched, but not locked with the mortise lock.
- i). Design Safety Validation
- i). The Contractor shall conduct a hazard analysis and a Failure Mode and Effects Criticality Analysis (FMECA) for hardware and a Fault Tree Analysis (FTA) for the entire side door system as necessary to demonstrate that the safety requirements of the system are met under all operating conditions.
 - ii). This analysis shall be performed for an individual car of each type and for a train consisting of cars from the same build lot. This shall include:
 - (1) logic,
 - (2) interlocks,
 - (3) mechanical mechanisms,
 - (4) indicators,
 - (5) bypasses,
 - (6) cutouts and
 - (7) controls.
 - iii). The analysis shall be submitted to Amtrak **[CDRL 12-03]** for review and acceptance as part of the Design Review process.

m). Door Markings

- i). Door positions shall be numbered in accordance with **Figure 12-1**.
- ii). In addition, each door shall be labeled for emergency egress in accordance with APTA Standard SS-PS-002-98, Rev. 2.
- iii). Signage shall be installed on each door leaf that describes the procedure for opening the doors in the event of an emergency.
- iv). This signage shall conform to the requirements of APTA Standard SS-PS-002-98 and 49CFR Part 238.
- v). Signage shall also be provided above each door leaf or pair of door leaves, adjacent to the yellow door status LED indicator, that states that the door leaf is inoperative or out of service when the yellow light is flashing.
- vi). A sign shall be installed on the exterior of the A-end vestibule doors on the café/lounge car that states NO PASSENGER ENTRANCE.
- vii). The proposed artwork, material, color, size, location and adhesive for these signs shall be submitted for Amtrak approval during the design review process. **[CDRL 12-04]**

12.5 Powered Carbody End Doors and Interior Passenger Area Doors

a). General

i). Carbody End Door

- (1) Electrically operated, stainless steel, single leaf body end frame doors, with fixed windows, shall be provided at each end of the car.
- (2) Carbody end doors shall be provided in addition to the open gangway between cars.
- (3) The end door shall have a minimum footprint within the passenger area, pressure sealed, mechanically lockable and integrated to the gangway.
- (4) A minimum 32 in. "clear passage" shall be provided through the doorway when the end door is fully opened.

ii). Interior Passenger Area Doors

- (1) An electrically powered sliding door shall be located at all areas that separate passengers from communal areas, i.e. café, restrooms, loading areas, etc.
- (2) Each door leaf shall incorporate a service-proven obstruction sensing system.
- (3) No door closing warning shall be given.

b). Door Controls

i). Carbody End Door

- (1) Body end door controls shall include the following features:
 - (a) An infrared (IR) proximity sensor, kick plate, and push buttons shall be installed on both sides of the body end door for passenger activation, and
 - (b) a three (3) position toggle switch shall be provided with three distinct modes of end door operation, NORMAL, DOOR OPEN, and MANUAL.
 - (i) The switch shall be mounted to a stainless-steel faceplate with engraved lettering and a red switch guard which shall fully close only when the switch is in NORMAL position.
- (2) In NORMAL mode:
 - (a) the end door shall automatically open fully within 2 seconds after the proximity sensor or push button is activated.
 - (b) The end door shall remain open for 8 to 15 seconds, then automatically close.
 - (c) All parameter settings and door timings shall be easily adjustable by PTU.
- (3) In DOOR OPEN mode:
 - (a) the end door will automatically open and remain open.
- (4) in MANUAL mode:
 - (a) electrical power shall be removed from the end door operator.
 - (b) The force to open or close the doors manually shall not exceed 20 lbs.
 - (c) The door shall be held in either the open or closed position with the vehicle subjected to track super elevation up to 7 in. (178 mm).

ii). Interior Passenger Area Door

- (1) Each interior passenger area door shall be passenger operated on each side by both a ceiling mounted infrared proximity sensor, side door frame mounted push button, and a kick plate electrical switch.
 - (a) The proximity sensor shall have an adjustable detection range, suitable for the railroad environment and shall not open the door for typical nearby passenger movements (such as

- accessing nearby luggage racks, etc.) when doorway passage is not intended.
 - (b) It shall easily permit future adjustments in sensitivity and detection zone by Amtrak.
 - (c) Details must be submitted for approval by Amtrak.
 - (d) Approved LED back lighted push plate switches shall be used.
 - (e) The switches shall be back lighted when the door operator is in Normal mode.
- (2) A backup local manual control shall be provided.
 - (3) Each door operator shall have a local electronic control unit which controls the door operation, that is self-checking and provides fault identification information.
 - (4) The control unit, as part of its self-diagnosing capability, shall provide performance degradation diagnostics to identify components approaching possible failure.
 - (5) Control circuitry shall be arranged so that a local door failure does not affect the door operator at the other end of the car.
 - (6) Each door operator shall include a maintenance switch which will remove power from the motor to prevent operation while maintenance work is in process.
 - (a) All functions will be available, including diagnostics.
 - (7) The door equipment mounting and internal fasteners shall be such that once adjustments are made, and locked, they need not be disturbed until equipment overhaul or replacement.
 - (8) Access shall be provided from inside the vestibule to all points necessary for service, installation or removal of powered doors and operating apparatus.
- c). Door Lock
- i). Car Body End Door
 - (1) The car body end door shall be equipped with a robust and service proven door lock that shall be lockable from inside the car, using a crew key.
 - (2) The door shall not be lockable from the exterior side of the car.
 - (3) A separately operated safety override shall be provided to unlock the door from inside or outside the car in the event of an emergency.

- (4) When the door is in the locked condition and the lock override is used, the door will return to the locked position when closed.
 - (5) The arrangement provided for locking the end door shall be approved by Amtrak.
 - (6) A carbody end door or similar shall be provided in the utility car to separate any passengers from the dedicated crew area.
- d). Door Operator
- i). Power Requirements
 - (1) The door operator and controls shall operate from nominal 74VDC car battery system.
 - (2) The door operator and controls shall operate normally over the entire voltage range of charging down to load shed without damage and without affecting the reliability and serviceable life of the operator.
 - ii). Opening and Closing Forces
 - (1) The drive mechanism shall be designed to minimize torque applied to the door panel during operation.
 - (2) The operator and linkage for the doors shall be arranged so the maximum force required to manually move a door panel with power removed shall not exceed 20 lbs.
 - (3) The door shall open or close successfully with no more than a 60 lbf applied perpendicular to the interior door surface at a height of 56 in., throughout the entire opening and closing cycle.
 - iii). Dampening and Door Motion
 - (1) The door operator shall preclude slamming or rebound and shall bring it to rest gently at the extremity of door leaf travel.
 - (2) The door motion shall be smooth and free of shock and impact.
 - (3) Damping shall be provided at the ends of travel of the door panel in both the opening and closing directions.
 - (4) In the opening direction damping shall preclude the door leaf from contacting the mechanical door stop.
 - (5) Door leaf travel shall be easily adjustable through a single adjustment point to set open and close positions.
 - iv). Door Holding and Locking Capability

- (1) The operator shall be capable of holding the door, without oscillation, in either an open or closed position with the car in service.
 - (2) Also, the operator shall include an over-center mechanism so that a door will remain in the open or closed position upon loss of power.
- v). Protection from Damage
- (1) Operator design shall be such that a mechanical or electrical failure shall not result in subsequent damage to other equipment.
 - (a) For example, if the operator linkage to the leaf comes loose, it shall not be possible for the operator to damage itself from over-travel of the mechanism.
 - (2) The door operator and drive motor shall be protected from damage created by in-service conditions.
 - (3) Stall protection will be provided to prevent operator or control damage or degradation should a leaf be immobilized.
 - (a) When the problem is corrected, the operator will return to full functionality without a manual reset.
 - (b) Thermal cutouts shall not be used for motor protection.
- vi). Limit Switches and Proximity Sensors
- (1) All limit switches and proximity sensors used in the operator shall be hermetically sealed and easily replaceable.
 - (2) All limit switches and proximity sensors shall be precision units that are positively and precisely located so they may be replaced without the need for mechanism adjustment.
- vii). Opening and Closing Times
- (1) Door opening and closing times shall be independently adjustable and shall be initially set with DC bus voltage with HEP on, at:
 - (a) Opening: 2.5 (\pm 0.5) seconds
 - (b) Closing: 3.0 (\pm 0.5) seconds
- viii). Door motor control and timing function shall be incorporated on the operator unit.
- ix). Reliability
- (1) The door operator shall require adjustments no more frequently than every 460 days.

- (2) The door motor and operator assembly shall be suitable for operation without component replacement between heavy overhaul periods of at least eight years.
 - (3) The door motor shall be a sealed design and suitably protected from the surrounding environment.
- x). Interchangeability
 - (1) All door operator motors shall be interchangeable from one door position to another.
- e). Door Panel Construction
 - i). Doors shall be constructed of stainless steel and have a honeycomb core.
 - ii). In addition, when supported at both ends, the door leaf shall sustain a concentrated load of 250 lbs applied at the center of the front face, applied over 4 sq.in. at 90° to the plane of the panel, without deflecting more than 0.25 in. nor shall the panel take a permanent set.
 - iii). Door panels shall be equipped for emergency escape per 49 CFR Part 238.112.
 - iv). All door panel joints and edges shall be sealed against moisture.
 - v). Stainless steel reinforcements shall be provided at attachment points.
 - vi). Structure used to secure the door leaf to the door hanger shall ensure it lasts the life of the car, without fatigue cracks or similar failure, even if the door operator malfunctions and slams the door leaf repeatedly.
 - vii). A hand-hold recess shall be provided on both sides of the door panel to allow manual opening of the door from the inside and outside, with the operator deactivated.
 - viii). Cutouts shall be provided on the inside and outside panels for the two push and kick plates and associated wiring.
 - ix). All internal door leaf wiring and sensitive edge tubing shall be run through internally routed conduit.
 - x). Each door panel shall have window openings formed to accept FRA Part 223 Type I compliant glazing.
 - xi). The door window frame shall be an integral part of the door structure and shall be capable of retaining the window in the door opening when subjected to the impact applicable to the window location described in 49CFR Part 223.
 - xii). The glazing and its mounting system shall not extend beyond the outer surface of the door.

- xiii). Door panels shall be fully insulated against thermal and sound transmission and grounded per APTA Standard SS-E-005-98.
- xiv). Door panels shall not rattle or vibrate
- f). Obstruction Detection
 - i). Each door leaf shall be equipped with a service-proven obstruction detection system.
 - ii). Should the door close against an obstruction, the obstruction detection system shall immediately initiate the door opening cycle.
 - iii). The force required to activate the system shall not exceed 20 lbf.
 - iv). The sensitivity of the obstruction detection system shall conform to APTA Standard SS-M-18-10.
 - v). The design of the obstruction detection system shall not allow the door to oscillate if no obstruction is present.
 - vi). The design of the obstruction detection system shall be subject to Amtrak acceptance during design review.
 - vii). The Contractor shall provide a detailed assessment of the obstruction detection system as proposed, including theory of system operation, proven service history, reliability and maintainability, compliance with applicable regulations and standards, and safety analysis.
- g). Overhead Door Track
 - i). Door leaves shall be suspended from an overhead door track.
 - ii). The track and door hanger assembly shall have minimum service life of 25 years.
 - iii). The track shall be convex with the curve on top, so as to be self-cleaning from buildup of dust.
 - iv). The door track shall employ concave rollers, with sealed, permanently lubricated bearings.
 - v). The overhead door track and rollers shall not be affected by environmental conditions, including the accumulation of dust.
 - vi). The door hanger and track shall be able to resist without damage or permanent deformation a force of 200-lbf applied perpendicular at the center of the door panel both in either the inward or outward directions.
 - vii). The rollers shall be secured to the hanger assembly with a mechanism, both to adjust for level as well as control vertical free-play between the hanger assembly and door track.

- viii). Door leaf adjustment shall allow the space between the nosing seal to be made constant from the top to the bottom of the leaf.
 - ix). The amount of track-to-roller free-play shall prevent the trailing edge roller from lifting on the track if the door leaf strikes an obstruction down low while closing.
 - x). Adjustment of free-play clearances shall be easily done using standard tools.
 - xi). The track itself and mounting to carbody (not the door-to-hanger connection) shall be adjustable to accommodate both carbody and door leaf tolerances, including both height and plumb.
 - xii). The door track and hanger shall not require lubrication over its life.
- h). Bottom Door Guides and Thresholds
- i). A door guide with corresponding threshold shall be provided at the bottom of the door.
 - ii). Wear strips, if provided, shall be easily replaceable without removing or readjusting the door panel.
 - iii). The bottom guide arrangement shall ensure operation with no binding or rattling.
 - iv). The door guide/threshold shall form part of the door weather seal and shall incorporate drain holes to carry off water to the underside the car.
 - v). The threshold and drain and their sealing to the carbody shall ensure water or other fluids do not enter the equipment room, nor do they seep underneath and cause deterioration of flooring, its substructure or insulation.
 - vi). Easy access shall be provided to the door guide/threshold for cleaning and maintenance.
 - vii). The guide shall be adjustable to accommodate both carbody and door leaf tolerances.
 - viii). The bottom guide shall not require adjustments more often than every 360 days.
- i). Weather Seal
- i). The leading edge of the door panel shall interlock with the door frame to form a weatherproof seal.
 - ii). The interior and exterior of the door opening, including any curves at the top, shall be equipped with a flexible weather seal.

- iii). The rear edge of the leaf shall be equipped with a batten that positively engages the door seal when the door is fully closed, including any radius at the top of the door opening.
- iv). This combination shall affect a dust- and weatherproof seal.
- v). The seal shall be attached to the door frame with sufficient clearance so as to prevent chafing against the leaf as it moves, yet ensure every door leaf seals on every car, despite the combination of all manufacturing tolerances.
- vi). The interface between the bottom of the door and the threshold shall form a weatherproof seal.
- vii). When door is manually locked a seal shall prevent air infiltration.
- viii). Seal design shall also limit the entrance of dust and snow into the door pocket when the door is open.
- ix). The entire door seal arrangement shall be demonstrated during the design review process to provide an effective door seal under all operating conditions and is subject to Amtrak acceptance.
- j). Door Pocket (If provided)
 - i). The door pocket will accommodate the door leaf while the door is open.
 - ii). Since the bottom of the carbody end door pocket is a wet area, it shall be lined with corrosion resistant material to prevent deterioration of car structure and flooring.
 - iii). This pan shall be designed to drain water out of the pocket area through a tube to the underside of the car.
 - iv). It shall be designed to ensure that water does not seep underneath and cause deterioration of flooring, its substructure or insulation, nor does not it freeze in the drain.
 - v). The drain shall be easily accessible for cleaning and shall be equipped with a backflow preventer to keep dust and moisture from blowing into the pocket.

12.6 End of Train Door

- a). A lockable manually operated, hinged collision post door shall be provided at the ends of each trainset at locations with an H type coupler between the collision posts.
- b). The door shall be constructed from stainless steel with a stainless steel honeycomb core and shall be equipped with an FRA Type 1 windshield.
- c). The door shall be weatherproof and compliant with the requirements of 49CFR 238.209.

- d). The door shall be of an adequate thickness for the intended service, which means it shall be resistant to minor wayside impact damage, as well as resist being bent from misuse.
- e). In addition, when supported at both ends, the door shall sustain a concentrated load of 200 lbs applied at the center of the front face over an area of 4 sq.in., at 90° to the plane of the panel without deflecting more than 0.25 in. nor shall the panel take a permanent set.
- f). The door shall be recessed from the front surface of the vehicle, so as to shield it from possible impacts.
- g). The door shall be designed to swing 100° into the car.

12.7 Onboard Mobility Device Lift

- a). Each car type shall include a proposal for an onboard mobility device lift on each side of the cars' vestibule.
- b). At Amtrak's option, this on-board equipment (as specified in the following articles), may be superseded by wayside-located portable lift equipment.
- c). The lowest station platform height for the purposes of the lift's lower reach shall be assumed to be 8" below the top of rail, to allow for emergency egress.
- d). The lift design shall also allow for operation when the car is on a curve with up to 7 in. of lean, due to super-elevation.
- e). The lift shall be fully compliant with 49 CFR Section 38.
- f). The lift proposal shall be service proven, modular, and of compact design to facilitate easy removal and replacement for servicing/repair.
- g). The lift operation and its associated equipment shall be automatic and suitable for one man operation under all ambient conditions through which these cars are expected to operate (see Chapter 3).
- h). The Contractor may propose alternative control configurations for one man operation for review and approval by Amtrak
- i). The controls for each lift shall be adjacent to the lift they control and shall allow a train crewmember to readily supervise all aspects of the lift operation and movements of the wheelchair occupant to/from the lift without obstructing or impacting the occupant's movements.
- j). In the event of lift failure or a power failure, it shall be possible to manually operate the lift to or from any position in the raising/lowering cycle, regardless of whether the lift is loaded or unloaded, and to stow and deploy the lift platform.
- k). Operation of the lift in manual mode shall not damage the lift or its components.
- l). A standard Amtrak coach key shall be required to operate the switch for each lift.

- m). The controls for the operation of the on-board lifts shall be interlocked to prevent train motion.
- n). Under power operation, the complete cycle of deploying the platform, lowering the lift to platform height, raising the lift to car floor height and stowing the lift platform shall require no more than between 30 and 60 seconds.
- o). The lift shall comply with the most recent RVAAC recommendations and any applicable ADA standards
- p). The wheelchair lift shall report alerts and faults to the car diagnostic system.
- q). The Contractor may propose other innovative solutions for onboarding passengers with mobility devices as an option.

12.8 Gap Filler

- a). The Contractor shall propose for Amtrak approval during the design review a service proven side door automatic gap filler system for station stops at high level station platforms, for assisting passenger boarding.
- b). The gap filler shall be robust, easily deployable and stowed and constructed with lightweight and high strength materials conforming to the requirements of 49 CFR Part 38 Subpart E for Commuter Rail Cars, latest version, for ADA compliance and shall be no less than 32" wide.
- c). The gap filler shall deploy automatically prior to door opening, when the doors are operated from a door control panel.
- d). It shall deploy only when the train is stopped and shall fully retract and stow when the door is closed.
- e). It shall not deploy if the door leaf is cut out or out of service.
- f). Interlocks shall be provided to prevent train motion whenever the gap filler is extended and also to prevent deployment of the gap filler prior to the train coming to a complete stop.
- g). An emergency retract feature shall be provided such that when activated the gap filler will return to stowed position in the event of loss of power.

12.9 Passenger Room Entrance Doors (Sleeping Accommodations)

- a). General
 - i). A robust and service proven sliding pocket entrance door shall be provided for each passenger room entrance door.
 - ii). The door shall be designed for low weight, sufficiently rigid, and strong construction to withstand when mounted and closed, a horizontal load of 330 lbs. (149.82 kg) applied at any point without permanent deformation.

- iii). The door shall not rattle or squeak in any position and shall be sealed when closed to provide a highly soundproof barrier.
 - iv). The interior door face shall be consistent in appearance with the room modules.
 - v). The door itself and the partition door frame shall be of sufficient strength to not deflect, bend nor deteriorate from door slamming typical of normal car operation in the railroad environment.
 - vi). A louver shall be provided at the bottom of the door as a path for HVAC return air to exit the room.
- b). Windows
- i). Safety glass windows in the partition shall be included to provide natural light and enhance the room spaciousness.
 - ii). Windows shall each be ¼" thick with the following nominal dimensions:
 - (1) 17" x 44" in the door
 - (2) 15½" x 30½" in the partition wall.
 - iii). The door window shall be removable from either side through the use of a pry-out rubber zip strip as an emergency escape route should the door be jammed closed requiring 25 lb-f or less to remove the window.
 - iv). The window shall be equipped with a privacy screen or alternates to be proposed for privacy and to block out hallway lights for sleeping.
- c). Door Operating Components
- i). The door shall be suspended from an adjustable, self-cleaning, heavy duty overhead low friction track.
 - ii). The force to open or close the door shall not exceed 10 lbf, once the détent is overcome. No less than 15 lbf shall be required to overcome the detent.
 - iii). The track rollers shall be sacrificial to the track for wear.
 - iv). The door will be stabilized at the threshold by an adjustable, self-cleaning guide at its leading edge only.
 - v). An approved détent shall be provided to keep the door in the open position during train motion under all train operating conditions at all authorized speeds on any FRA class of track.
 - vi). A damper shall be provided to dampen a slamming door.
- d). Door Pocket

- i). The door and pocket walls shall be free from resonance, rattles and/ or banging in open, closed or closed & locked positions when the train is in motion under all train operating conditions at all authorized speeds on any FRA class of track.
 - ii). An approved flat spring or similar anti-rattle device shall be provided to keep the door from rattling.
 - iii). The gap between the door and the edges of the door pocket shall be sized to avoid pinch points.
 - iv). The door shall not rub the door pocket in any way that marks the door with horizontal lines or scratches, etc.
 - v). Door pocket design shall discourage inadvertent use as a trash receptacle; it shall be possible to access the rear bottom of the pocket for cleaning or to retrieve objects trapped there. It shall be intended that the door perimeter gaskets prevent a line of sight to the compartment from other passengers.
- e). Door Latch System
- i). A robust and service proven latch shall be provided that operates with keyless RFID technology.
 - (1) It shall incorporate the Amtrak standard coach key for override.
 - ii). The attachment of the latch and its keeper to the door and partition door frame respectively shall be sufficiently rigid so that it does not flex when the door closes, even if it is slammed; the intention is that this interface does not deteriorate over the life of the car.
 - iii). Likewise, the interior of the door and partition construction shall incorporate interior stiffening in the area where the latch is attached to the door, so that the fasteners securing it to the have a solid surface on which to clamp, rather than a somewhat resilient one.
 - iv). A latch, latch guard and keeper, directly interchangeable with and similar to J L Howard # 2935 shall be provided on the inside of each door, to allow the passenger to secure the door when the room is occupied.
 - (1) It shall require definite action to engage to avoid accidental room lockout.
 - v). The latch, when engaged, shall keep the door in the fully closed position under all train operating conditions at all authorized speeds on any FRA class of track at any permissible train speed.
 - vi). In an emergency, it shall be possible to disengage the latch from the hallway side with a screwdriver.
 - vii). An aesthetically pleasing method shall be provided to lock all dormitory rooms with an external personnel crew padlock.

- viii). An instruction, in accordance with Amtrak specification # 697, located on the interior side of the door, shall provide latch operating instructions.
- ix). Each sleeper car shall contain at least one unit to reprogram any RFID key cards while enroute.
- f). Reliability
 - i). The passenger room entrance door shall undergo endurance testing to verify the door installation is not subject to premature wear.
 - (1) This shall include:
 - (a) Simulated door installation: door, track, module structure supporting track, door frame with adjoining partition, door latch assembly, detent, etc.
 - (b) 24,000 Open-close cycles with every tenth slammed
 - (c) Every 100 cycles, latch/ unlatch the door
 - (d) Measurement of change from initial setting at every 1500 cycles
 - (e) Measurement of force required to open/ close door every 1500 cycles
 - (f) Mutually agreed upon pass/ fail criteria shall be determined for allowable wear in advance of starting the test.
 - ii). Both track and détent shall be able to operate over 5 year maintenance cycles without adjustments or maintenance required.
 - iii). The design life of the door track and complete door installation shall be at least 30 years.
 - iv). The latch system shall be able to operate over 5 year maintenance cycles without adjustments or maintenance required.
 - g). Maintainability
 - i). The following shall be possible with only the need to open the hallway ceiling panel outside the room; no disassembly of the room partition is allowed:
 - (1) Disengage the door from the door mechanism
 - (2) Remove room door through door opening
 - (3) Remove door track
 - (4) Remove door détent (all pieces)
 - (5) Adjust the track and détent

12.10 Automatic Sliding Restroom

- a). The lock shall be operable from the outside with a standard Amtrak Conductor coach key. An LED indicator light TOILET ROOM OCCUPIED on the outside of the toilet room, and a LED indicator light DOOR IS LOCKED WHEN LIT on the inside of the toilet room, activated when the door is locked (see Chapter 11). A decal shall provide door lock operation instructions.
- b). In the event that the door operator is in fault, the door shall be operational in manual mode to open, close, and lock.

12.11 Accessible Rooms

- a). Accessible bedrooms shall be unlocked by way of the key card technology described in 12.12.e.
- b). The lock shall be operable from the outside with a standard Amtrak Conductor coach key.
- c). In the event that the door operator is in fault, the door shall be operational in manual mode to open, close, and lock.

12.12 CDRLs

CDRL	Description	Due
CDRL 12-01	Tone and Volume of Audible Signal	30 days prior to PDR
CDRL 12-02	Engineering analysis of side door operator's ability to operate over full HEP voltage range without damage.	30 days prior to IDR
CDRL 12-03	Side Door System Failure Mode and Effects Criticality Analysis (FMECA) and Fault Tree Analysis (FTA)	30 days prior to IDR
CDRL 12-04	Proposed door signage samples, location and adhesive	30 days prior to IDR

* End of Chapter 12 *

Amtrak Long Distance Bi-Level Fleet Replacement

Technical Specification

13. Lighting System

Revision 1

Table of Contents

13.1	Overview	13-1
13.2	General Requirements	13-2
13.3	Lighting Plan Design Review	13-3
13.4	Interior Lighting Levels	13-4
13.5	Interior Lighting Modes	13-5
13.6	Interior Lighting Requirements.....	13-7
13.7	Interior Accent RGB Lighting	13-13
13.8	Interior Backlighting	13-14
13.9	Exterior Lighting Requirements	13-14
13.10	Systems Indicator Panel.....	13-16
13.11	Lighting Component Requirements	13-16
13.12	Housings, Lenses and Diffusers	13-19
13.13	Controls.....	13-21
13.14	LLEPM and HPPL Emergency Signage.....	13-23
13.15	Minimum Illumination Levels.....	13-23
13.16	CDRLs.....	13-25

Table of Figures

Figure 13-1:	Minimum Illumination Levels	13-24
--------------	-----------------------------------	-------

13.1 Overview

- a). This Section describes the interior and exterior lighting system that shall be provided on all car types.
- b). The lighting system as designed shall enhance the appeal of interior furnishings and create a comfortable and pleasant atmosphere while providing for maximum passenger and crewmember safety.
- c). Normal and emergency lighting shall conform to the requirements of all applicable APTA standards and FRA regulations.
- d). Automatic load shedding of certain lights shall take place when the train Head End Power (HEP) supply is interrupted, and the battery voltage drops to certain levels.
- e). All lighting equipment shall meet the requirements of Chapters 15 and 20, the voltage swing requirements of Amtrak Specification 429, and the environmental requirements of Amtrak Specification 963.
- f). Lighting system components shall not cause radio frequency interference (RFI) to any train or operations systems.
- g). The lighting system shall provide six modes of interior lighting: normal, quiet car, night, standby, emergency and off.
- h). Interior and exterior lighting, as well as indicator lights, shall be provided by Light Emitting Diodes (LEDs) and will be supplied by the low voltage DC system
- i). Other state of the art lighting technology may be proposed to Amtrak for review and acceptance.
- j). Elements of this lighting system will be available for use as the standby lighting.
- k). Fluorescent, Incandescent and Halogen lights shall not be used except as specified.
- l). For lighting requirements in the food service areas of the food service cars, see Chapter 16.
- m). The Contractor shall prepare and submit an interior and exterior lighting plan **[CDRL 13-01]** for Amtrak review and acceptance during the design review. The plan shall describe the type of lighting to be used in all applications, including:
 - i). fixture type,
 - ii). voltage and color temperature,
 - iii). illumination levels at specified locations for all lighting modes, and
 - iv). compliance with emergency lighting and signage regulations and standards.

13.2 General Requirements

- a). Fixtures installed in the interior within 3 ft. of a doorway that can be exposed to weather when the door is open, shall be watertight to IP55 or better.
- b). Fixtures installed on the vehicle exterior shall be watertight to IP56 or better.
- c). Car interior lighting shall provide adequate and convenient illumination under all ambient lighting conditions from complete darkness to bright sunlight.
- d). Lighting in all locations shall be arranged to minimize shadows, avoid glare and excessive brightness ratios.
- e). Lighting shall be appropriate for the application, easily maintainable and compliant with all regulations and standards including this specification.
- f). Luminaires of differing voltages shall not share the same base design, and luminaires shall not be interchangeable between fixtures with differing voltages.
- g). Commonality and standardization of components between fixtures should be used wherever possible.
- h). Unless otherwise specified, the interior lighting shall be based on the latest guidelines of all of the following:
 - i). the Illuminating Engineering Society (IES) of North America
 - ii). the requirements of the American Public Transportation Association (APTA) standards:
 - (1) PR-E-RP-002-98: Wiring of Passenger Equipment
 - (2) PR-E-RP-012-99: Normal Lighting System Design for Passenger Cars
 - (3) PR-E-S-013-99: Emergency Lighting System Design for Passenger Cars
 - (4) PR-PS-S-004-99: Low-Location Exit Path Marking.
- i). All lighting components shall have prior experience in North American transit, commuter rail or intercity passenger rail application.
- j). All lighting sources shall be suitable for rough duty service found in the railroad environment throughout North America.
- k). At its sole discretion, Amtrak may accept other components based upon provided shock and vibration test results, and radio frequency interference analysis.
- l). The Contractor shall provide drawings of the lighting arrangement of each vehicle type, and the location and quantity of each lighting fixture, switch, control, and luminary type.
- m). All luminaires used in all fixtures shall be readily available through a U.S.

distributor and available from multiple sources.

- n). All luminaires must be replaceable without replacing the entire fixture or requiring specialty tools except where approved by the Amtrak.
- o). All controllers shall report alerts and fault information to the car diagnostic system.
- p). The design and all components of the lighting system shall be submitted for review and acceptance by Amtrak during Design Review.
- q). All materials and workmanship shall comply with Chapter 19.
- r). The lighting fixture housing or socket shall not be used as a ground return for any other electrical circuits.
- s). Lighting fixture and consumable types shall be consolidated as much as practical.

13.3 Lighting Plan Design Review

a). Customer Experience Design Review

- i). All lighting, including but not limited to interior lighting arrangements, light fixtures and lens design options shall be reviewed as part of both the technical and customer experience Design Review process.
- ii). During the Design Review process, the Contractor shall provide options for lighting system components which may include different light fixture shapes, arrangements, and use of accent and backlighting effects.
 - (1) At Preliminary Design Review, the Contractor shall show lighting design concepts in line with design vision shown in Figures throughout Chapters 11 and 16 and exhibit F.
 - (a) All lighting positions and lighting treatments for indirect lighting shall be presented as soft mockups.
 - (2) Soft-Mockups shall include light control and color transition demonstrations that will represent the same effects as the final controller design.
 - (3) Soft-Mockups shall be used as a development tool to rearrange and test different lighting arrangements and effects.
 - (4) Mockups shall be reviewed and periodically updated during design review until completion and approval of Final Design Review.
- iii). Refer to Chapter 3 for additional details on the customer experience design review process.

b). Design Review

- i). The Contractor shall provide drawings of the lighting arrangement of each car type for Amtrak review and acceptance during Design Review. Outline

drawings shall be submitted at PDR and updated for FDR submittal. **[CDRL 13-02]**

- ii). General arrangement and locations concepts for white LEDs and Accent RGB lighting shall be submitted at Preliminary Design Review. **[CDRL 13-03]**
- iii). Fixtures providing standby and/or emergency lighting shall be identified at Preliminary Design Review. **[CDRL 13-04]**
- iv). The location of each lighting fixture, circuit breaker size and location, switch, control, luminary type, color, luminance value (in footcandles) and quantity shall be clearly identified at intermediate design review and updated for FDR submittal. **[CDRL 13-05]**
- v). Required charging light levels for photo luminescent (HPPL) emergency exit signage and Low Location Exit Pathway Markings (LLEPM) components will be identified during Design Review and validated during qualification testing. **[CDRL 13-06]**
- vi). Physical examples of each lighting fixture shall be provided for Amtrak review and approval at the Final Design Review. **[CDRL 13-07]**
- vii). Lighting fixtures shall not be a source of Electromagnetic Interference (EMI) and shall be included in the Electromagnetic Compatibility (EMC) plan required by APTA Standard PR-E-S-010-98. See Chapter 20.
- viii). The Contractor shall provide certification to Amtrak that the car's lighting system meets all standards and regulations **[CDRL 13-08]**

13.4 Interior Lighting Levels

a). Lighting Standards

- i). All light level measurements shall be made in accordance with the minimum standards defined by the following APTA standards:
 - (1) PR-E-RP-002-98: Wiring of Passenger Equipment
 - (2) PR-E-RP-012-99: Normal Lighting System Design for Passenger Cars
 - (3) PR-E-S-013-99: Emergency Lighting System Design for Passenger Cars
 - (4) PR-PS-S-004-99: Low-Location Exit Path Marking.
- ii). Where lighting levels in Figure 13-1 differ from APTA PR-E-RP-012-99, the requirements indicated in Figure 13-1 shall be used.

b). Lighting Color Temperatures

- i). The lighting color for all white interior luminaires throughout the car shall be in the range of 3000°K to 4100°K, +/- 500°K between any lights, and

accepted by Amtrak. LED luminaires shall have a color rendering index (CRI) of at least 80, with the same color consistency and color stability.

- ii). The Contractor is to provide a suggested light color plan for Amtrak's review and approval during the preliminary design review. **[CDRL 13-09]**
- c). Minimum Lighting Illumination
 - i). The minimum spatial average of illumination shall be at the points listed in Figure 13-1, and shall meet the minimum value(s), measured in foot-candles, with all lights on and at the rated voltage when the equipment is new.

13.5 Interior Lighting Modes

- a). Mode Control
 - i). See Section 13.13 for Control Description.
- b). Normal Lighting Mode
 - i). Normal lighting mode shall be available when the car is operating from a Head End Power source.
 - ii). All lighting fixtures and elements intended for use while the car is in revenue service shall be available during normal lighting mode.
 - iii). Minimum illumination levels for normal lighting mode are shown in Figure 13-1.
- c). Quiet Car Mode
 - i). Normal lighting mode in the car shall be arranged to allow the level of lighting to be reduced for passenger comfort during early morning and late evening operation, while maintaining sufficient lighting for passenger and crew safety, and compliance with standards and regulations.
 - ii). This reduced light level, referred to as "Quiet Car" mode, may use any combination of lighting elements so long as minimum light levels are maintained at "Standby" illumination levels throughout the car, and all light fixtures operating during quiet car mode remain powered at all times.
 - iii). Car lighting during quiet car mode shall be adequate to charge the photo luminescent emergency signage and LLEPM system per the required standards.
 - iv). A dedicated, clearly labeled switch in the electric locker shall permit operating personnel to easily select either normal lighting or quiet car mode lighting.
 - v). Minimum illumination levels for quiet car mode are shown in Figure 13-1 under the "Quiet Car" column.

- vi). The Contractor shall carefully design the lighting fixtures and their controls to permit the Quiet Car lighting mode to have a minimum of glare and annoyance to sleeping passengers, especially those seated adjacent to the aisle.
- vii). Light reflections and glare from bright metal body end doors shall be minimized.
- d). Night Lighting Mode
 - i). Night lighting shall only provide minimal illumination to aiseways to allow safe passenger movement and not disturb seated passengers from resting.
 - ii). Night lighting mode shall not negatively impact the light intensity levels of all food and beverage service locations. All FDA light intensity level requirements for food preparation counters, sinks, and workspaces shall be maintained by shelf lighting alone. See Sections 11 and 16 for additional information.
 - iii). The selection of lights being powered in this mode will be determined during design review when the lighting arrangement concepts are drafted.
- e). Standby Lighting Mode
 - i). Standby lighting is that which is available when the trainset has lost 480VAC Head End Power (HEP) but the car battery has not yet discharged to load shed.
 - ii). This lighting mode is intended to keep sufficient lighting operational for a period of at least 90 minutes so that short term loss of HEP will not affect the passengers' ability to safely move throughout the trainset.
 - iii). Car lighting during standby mode shall be adequate to maintain the light charge for the HPPL photo luminescent emergency signage and LLEPM system per the required standards.
 - iv). Minimum illumination levels for Standby mode are shown in Figure 13-1.
- f). Emergency Lighting Mode
 - i). Emergency Lighting mode is that which is available after load shed has occurred. See Section 15 for load shed details.
 - (1) This lighting provides passenger orientation and sufficient light levels for passengers to move about safely within the car and if necessary, to find the nearest safe exit point.
 - (2) It is especially important in stairways, aisles, vestibules and enclosed spaces, such as toilet rooms.
 - ii). Emergency Lighting mode shall operate by hardware only. Software control of emergency light mode or intensity levels is prohibited.

- iii). Emergency Light Intensity shall be met using the L70 end of life cycle light output levels.
- iv). Once the low voltage system reaches a pre-determined low-voltage threshold, all standby lighting is extinguished and emergency lighting shall illuminate.
- v). This lighting system may use dedicated fixtures, may provide a reduced level of illumination from the normal lighting system, or may use some but not all of the normal lighting fixtures.
- vi). The emergency lighting system shall be powered by independent power sources for a minimum of 90 minutes as defined in APTA Standard PR-E-S-013-99.
- vii). End-of-life self-diagnostic and test functions shall be included with the emergency lighting system.
- viii). Emergency lighting shall comply with 49 CFR Part 238.115 and APTA Standard PR-E-S-013-99.
- ix). Energy storage components, batteries or capacitors must have all contacts and terminals covered to prevent shorting during storage or installation, and easily changed out using a connector.
- x). Energy storage components shall be common between all fixtures whenever possible.
- xi). The Contractor shall submit an Emergency Lighting Plan to Amtrak for review and acceptance during Design Review [**CDRL 13-10**].
 - (1) The Emergency Lighting Plan shall describe and illustrate the emergency lighting system, including location, type and design of all lighting fixtures and the level of illumination that shall be provided at all points as identified in APTA Standard PR-E-S-013-99.
- xii). The Contractor shall demonstrate compliance with emergency lighting requirements and shall provide to Amtrak written certification of compliance. [**CDRL 13-11**]
- g). Cleaning Mode
 - i). Cleaning Mode is a temporary mode that increases the interior light intensity to 30 foot candles to facilitate cleaning. See Section 13.13.b). for additional details.

13.6 Interior Lighting Requirements

- a). Passenger Area
 - i). General

- (1) The following describes the individual lighting fixture applications and specifications for all passenger areas of the car.
 - (2) Light fixtures in toilet room ceiling, vestibule ceiling and hallway ceiling shall be identical units if possible.
- ii). Main Ceiling
- (1) Longitudinal rows of lights shall provide the primary lighting for the revenue seating areas of all car types, and the passenger area of the food service car.
 - (2) Indirect lighting shall be the source of illumination to meet minimum illumination levels.
 - (3) Other arrangements can be proposed but are subject to Amtrak review and acceptance.
 - (4) These LED fixtures provide the main light source to the car and provide lighting to the aisle as well as general lighting to the seating areas.
 - (5) The fixtures shall be trough-construction units, mounted end-to-end. They shall be equipped with terminal blocks or connectors, as accepted by Amtrak, wired in parallel fixture-to-fixture, including all bus wiring for the entire fixture string for normal, quiet car, night and standby modes.
- iii). Hallway Ceiling
- (1) Hallway ceiling lights shall be used to supplement main ceiling lighting to achieve necessary illumination levels. Lighting shall be the same indirect style as the main ceiling. Direct lighting shall not be used unless specifically requested by Amtrak.
- b). Reading Lights
- i). General
- (1) Reading lights shall be white LEDs powered by 74 VDC, 24 VDC or other approved DC voltage.
 - (2) They shall be mounted such that illumination requirements are achieved. Each reading light shall have an on/off switch.
 - (3) Reading lights shall have a maximum light intensity of 20 foot-candles when measured at a seated passenger's lap. Light intensity shall be passenger adjustable by either a dimmer switch or an integrated on/off/dimmer switch.
 - (4) Reading light orientation shall be passenger adjustable, within a limited range and beam dispersion to prevent disturbing adjacent passengers.

- ii). Reading Lights for Main Passenger Seating
 - (1) Individual reading lights built into each revenue seat or overhead for an accessible location.
- iii). Reading Lights for Nest, Roomette, and Bedrooms
 - (1) A reading light shall be provided for each seating location.
 - (2) The in-room HMI control panel shall also control power and brightness of each reading light and shall work in parallel with the discrete switch.
 - (3) Location and arrangement of reading lights shall be proposed to Amtrak for review and acceptance during PDR.
- c). Bedroom Lighting
 - i). General
 - (1) Each sleeper room shall be equipped with indirect overhead lighting, accent RGB lighting, and a night light.
 - (2) Each light source shall be controllable in parallel by both the in-room HMI control panel and a local physical switch, both of which have priority over the train crew lighting controls described in Section 13.13.a).
 - (3) The HPPL backlighting will be powered on regardless of any light switch position.
 - ii). HMI Lighting Control
 - (1) The lighting in each bedroom configuration shall be divided into functional zones. Zones shall include ceiling wash lighting, wall wash lighting, berth lighting, bed lighting, compartment lighting and bathroom lighting. See Chapter 11 for additional information.
 - (2) The HMI screen in each room shall be able to control the light intensity for each zone individually.
 - (3) The HMI screen in each room shall have the ability for the passenger to select pre-programmed RGB lighting settings. Pre-programmed settings shall be Amtrak adjustable configuration files.
 - (4) The HMI user interface shall be graphical and not require the passenger to input values or numbers.
- d). Vestibules and other Non-Seating Areas
 - i). Flush-mounted overhead light fixtures

- (1) Overhead lighting fixtures in vestibules and non-seating areas shall be proposed to be aesthetically appealing rather than an industrial type fixture.
 - (2) The Contractor shall propose several alternative fixtures for each of these locations during PDR for review and acceptance.
 - (3) Amtrak reserves the right to reject the proposed fixtures and request additional proposals until a satisfactory fixture is proposed.
 - (4) Flush-mounted overhead light fixtures with LED light elements shall be provided in the following locations for the purposes of commonality and interchangeability:
 - (a) Gangway/end passageway
 - (i) The end passageway light(s) shall be a weatherproof, sealed light unit mounted overhead adjacent to the gangway on all car types.
 - (ii) The unit shall cast adequate light throughout the passageway area including handholds, door panel, walkway surface, signage and handbrake.
 - (b) Ceiling at side entry doors
 - (i) Flush-mounted lighted ceiling panel fixtures shall provide overhead light to the areas adjacent to the side entry doors and adjacent station platform.
 - (ii) The lighted panel assembly shall provide indirect lighting towards the center of the panel.
 - (iii) The same fixture shall be used at all side entrance locations, including service vestibules in the food service and lounge cars.
- e). Toilet Rooms
- i). Toilet ceiling and mirror
 - (1) Light fixtures shall be mounted on the ceiling of each toilet room to provide general lighting to the toilet room.
 - (2) Care shall be taken to provide good color rendition for cosmetic makeup application and other personal grooming purposes.
 - (3) Lighted mirror designs shall be presented in the toilet rooms during design review.
 - (a) A concept for a rounded LED light that illuminates the mirror around the boarder shall be presented at Preliminary Design Review.

- (b) A concept for a backlit mirror shall be presented at Preliminary Design Review.
 - (c) The mirror light shall only be activated when the door to the restroom is locked. It shall be off when the door is unlocked to raise awareness to the passenger.
 - (4) The lighting fixtures shall be provided as part of the toilet module.
 - (5) Toilet room occupied/out of service sign
 - (6) There shall be a toilet occupied/out of service light fixture associated with each shared toilet room.
 - (7) The toilet occupied/out of service light fixture shall be mounted on the toilet room exterior wall, adjacent to the toilet room door for all toilet rooms.
 - (8) This light shall consist of a two-light LED fixture with a sign containing text and/or a pictorial symbol which provides indication as to when the toilet room door is locked (occupied) and a second light that provides indication that the toilet room is "out of service" (when the toilet system is not functioning) as per Chapter 17.
 - (9) Lights shall be on when the toilet is occupied or out of service and shall be extinguished when the toilet is available for use. These LEDs shall be yellow.
 - (10) Artwork for the labels shall be submitted to Amtrak for review and acceptance during the design review. **[CDRL 13-12]**
 - (11) An indicator shall be provided inside the toilet room, adjacent to the door, that illuminates when the door is locked (parallel with the toilet occupied indicator outside the toilet room).
 - (12) This indicator shall be labeled door locked when light is on.
 - (13) Concept for indicator can be incorporated into the door open button; however, Amtrak will review and provide approval during design reviews.
 - (14) The Contractor shall reduce the light level in the toilet room, which changes to full brilliance when the toilet room door is properly locked.
- f). Service and Utility Rooms
- i). Electric/Utility locker(s)
 - (1) All electric/utility lockers shall be illuminated by a minimum of one overhead light, controlled by an automatic door open magnetic switch that turns on the light when the door is opened.

- (2) For the purposes of this section, storage lockers, storage cabinets and linen lockers shall be considered utility lockers.
 - (3) If more than one entry exists, each entry shall be equipped with a switch.
 - (a) The switches shall be wired in parallel to illuminate the lights regardless of which door is opened.
 - (4) The light fixture(s) shall be protected by a clear shatterproof glass or polycarbonate lens, or other suitable protection, and shall not be vulnerable to damage during normal maintenance activities.
 - (5) Lights shall be operable during all lighting modes.
 - (6) The lights shall be so located as to provide general illumination within the locker, provide sufficient illumination to read any signage within the room, and be readily accessible for replacement.
- ii). Utility/Equipment Rooms and Closets
- (1) For utility or equipment rooms, such as those located above the trucks, adequate lighting shall be provided for all potential maintenance activities in the space.
 - (2) Lights shall only turn on when the magnetic proximity switch detects the door or access panel is open. The lights shall turn on if there is a proximity switch failure.
 - (3) General lighting shall measure 20 foot-candles at the floor.
 - (4) Sufficient lighting shall be provided to illuminate all signage to 20 foot-candles.
 - (5) Any other areas that are called out for running repair maintenance tasks shall have sufficient lighting in the general area of 20 foot-candles at the floor.
- g). Food Service Areas (Kitchen, Servery, Bar, Café)
- i). Lighting requirements for the food service areas and seating areas of all food service cars are described in Chapter 16, except as noted.
 - ii). All food service areas are considered occupied areas and must have emergency lighting and emergency signage.
 - iii). Under-shelf spot or strip lights are preferred in Servery, Bar, and Café locations to localize the high light intensity and not impact the adjacent passenger interior areas.
 - iv). Servery, Bar, and Café locations must not depend on main interior car lighting as there are minimal lights on during quiet and night modes of operation.

- v). Food preparation and serving areas shall meeting the requirements of FDA Food Code 2022, Section 6-303 Lighting.
 - (1) All food preparation surfaces shall measure 50 foot-candles along the entire counter.
 - (2) Hand wash sinks shall measure 20 foot-candles at the center of the sink at the height of the hand detection sensor.
 - (3) All food and beverage displays shall measure 20 foot-candles at each shelf.
- vi). General kitchen area shall measure 20 foot-candles measured at the floor.
- h). Elevator Lighting
 - i). Elevator room shall have a main ceiling light that shall be on during all lighting operating modes.
 - ii). Elevator control panel shall have backlighting.

13.7 Interior Accent RGB Lighting

- a). Accent lighting shall be incorporated throughout the equipment as follows:
 - i). Along each aisle of coaches and sleepers
 - ii). In the ceiling and other interior points of interest in café, lounge and diner cars
 - iii). At other points within the trainset as proposed by the Contractor
- b). Accent lighting shall be applied through the use of hidden or recessed fixtures and shall be continuous and symmetrical along the passenger area to the best extent possible.
- c). Trim, ceiling and wall wash lights described in Chapter 11 shall be RGB unless otherwise specified.
- d). Accent lighting shall be capable of standard RGB mixes of no less than 16 different color combinations and shall be controlled by the main lighting controls HMI interface.
- e). Preset color combinations or sequences shall be programmable from the control unit.
- f). Pre-configured programs adjustable by Amtrak shall be capable of being loaded from an external source to be run automatically without the need to physically load configurations onto each trainset or car.
- g). Amtrak adjustable parameters used in the preset sequences shall include at a minimum: color light intensities, time of day, day of the year, time duration for transitions, external event triggers such as side door opening, and other lighting

effects.

- h). The method for creating preset sequences shall have a simplified user interface to create low complexity sequences. There shall also be an advanced user interface to create higher complexity sequences. User interface details shall be submitted to Amtrak for approval during design review **[CDRL 13-13]**.
- i). Any white accent lighting or white color selections shall meet the requirements of the specified color temperatures in this Section.
- j). There shall be accent lighting zones within each car. Each zone shall be capable of displaying a unique color.
 - i). All cars shall have a minimum of 4 different accent lighting zones: Vestibule area, stairway and elevator lift area, main interior area, and toilet room.
 - ii). Cars with sleeping areas shall also have unique accent lighting zones for each sleeping area. See Chapter 11 for additional details.

13.8 Interior Backlighting

- a). At a minimum, backlighting will be expected on all mirrors, displays and logos unless otherwise directed by Amtrak.
- b). Backlighting shall be reviewed during the interior design review process with renderings to provide lighting effect on mirrors, displays, advertising, company logos or other features that could be showcased.
- c). HPPL signage shall be charged by backlighting instead of overhead lighting per Section 13.14.

13.9 Exterior Lighting Requirements

- a). Standards
 - i). All exterior lighting components shall meet the environmental conditions specified in Amtrak Specification 963.
 - ii). All exterior lights shall be rated IP56 or greater.
- b). Marker Lights
 - i). All cars shall have two red marker lights at both ends.
 - ii). The marker lights shall be LED with thermostat-controlled heating elements to protect against frosting, or be recessed behind heated cover, and shall meet FRA requirements in 49 CFR Part 221.
 - iii). If LED's with heating elements are used, the condition of the heating system must be readily determined by simple visual inspection so that there is no risk of the marker visibility being diminished or obliterated. The heating element fault status shall also be reported to the car network.

- iv). Failure of the heating system will be considered a failure of the marker itself.
 - v). The marker lights shall be operable during all lighting modes operating off main car battery.
 - vi). The marker lights will be controlled by a crew operated switch in the car electric locker on the lower level.
- c). Platform Lights
- i). Each side door opening shall have a station platform light(s) that will illuminate the platform area adjacent to that door opening when those doors are opened.
 - ii). These lights shall be mounted flush into the carshell or the threshold area and not protrude beyond the side of the carbody.
 - iii). The lights shall be aimed downward so as to not shine directly into the eyes of passengers or crew standing on the platform or in the vestibule of the car and shall be mounted in an impact-resistant and waterproof housing.
 - iv). The platform lights shall illuminate when any door panel in the adjacent door opening is opened, either by command from the door control system, by use of the emergency door release or by a local manual switch if a manual door.
 - v). The platform lights shall remain off when the door panels are closed.
 - vi). Low level station platforms shall be illuminated to the requirements of Figure 13-1, which exceeds 49 CFR Part 38 and APTA recommended practice.
 - vii). The platform lights shall also be a part of the emergency lighting system and shall conform to APTA Standard PR-E-S-013-99.
- d). Step Lights
- i). If required, each side door step landing shall be illuminated to the requirements of Figure 13-1, which exceeds 49 CFR Part 38 and APTA recommended practice.
- e). Exterior Indicator Lights
- i). Each exterior indicator light shall be visible from both ends of the train of up to twenty-two car train length.
 - (1) Assemblies shall be designed to avoid false positive light indications from direct sunlight.
 - (2) Lens assembly shall be designed to avoid snow and ice buildup, either by shape of the assembly or by use of heated lenses.
 - ii). Each car shall be equipped with exterior door open indicator lights, one per side door.

- (1) These indicators shall be red LEDs and shall be located on the exterior of the car above and adjacent to the door, so that the status of each side door is visible to the Engineer when viewed down the side of the train.
 - (2) The indicators shall display a red indication when any door in the adjacent vestibule is open (i.e., not closed and latched) and shall be dark when all doors in that vestibule area are closed and latched.
 - (3) A small ceiling mounted indicator light, located in the side door vestibule adjacent to each door, shall also illuminate when the adjacent door is not fully closed and latched, as an aid to the train crew.
 - (4) See Chapter 12 for additional details.
- iii). Each car shall be equipped with two exterior brake indicator light units, one on each side of the car, as per Chapter 9.
- (1) Mechanical brake indicators may be used as an alternate to the indicator lights, if there is a brake status display elsewhere for the crew.
 - (2) Brake indicator light units shall use green, yellow, and flashing yellow LEDs.
 - (3) All indicator light assemblies shall be visible from both the front and the rear of the train, be able to withstand car washer brushes, and be located clear of any roof drains or gutters.

13.10 Systems Indicator Panel

- a). The systems in the cars should connect to a single user interface screen that allows monitoring of each by selection, preferably through the CDU or OTIS terminals. Control of systems will be set at different levels of authority.

13.11 Lighting Component Requirements

- a). Light Emitting Diode (LED) Lighting
 - i). LED fixtures shall conform to the requirements of the *Energy Policy Act of 2005* or more recent requirements. The correlated white color temperature throughout the car shall be in the range of 3000°K to 4100°K, +/- 500°K between any lights, and accepted by Amtrak.
 - ii). Where practical, the LED lighting should be supplied from the DC system and be available in both Normal and Standby lighting modes.
 - iii). All fixtures shall be dust and moisture resistant and shall be arranged to facilitate replacement of the LED luminaire from the passenger compartment.
 - (1) Luminaires shall be removable without special hardware after removing only the hinged lens if they are not replaced as a whole.

CONFIDENTIAL — DO NOT DISTRIBUTE

- iv). An LED driver designed to ensure proper operation of the LEDs shall be mounted on the LED assembly.
 - v). LED assemblies shall be connected via interlocking, self-polarizing and modular connectors accessible when the light fixture is opened. Connectors and jumper wires shall be white in color to minimize visible dark spots behind lenses.
 - vi). Power supplies shall comply with the requirements of Chapters 4, 15 and 20.
 - vii). LEDs used in passenger area overhead lighting shall be mounted on replaceable boards installed in the light fixture.
 - (1) Boards shall be connected to the fixture by screws and shall be plug-connected electrically for easy replacement.
 - (2) The LEDs shall be sized and spaced so that the failure of up to three LEDs on an individual board shall not create an appearance of a dark area on the fixture. This dark area may be driven by the number of LEDs in series within the array, depending on the design.
 - viii). LED lighting shall be sized to provide the level of lighting as outlined in Figure 13-1.
 - ix). Changeable LED luminaires are preferred, and LED lighting may be dedicated to its fixture where the design is necessary.
 - x). Using common LED/Driver boards is preferred whenever possible. The number of different boards shall be minimized.
 - xi). White LED luminaires shall have lumen maintenance of 70 percent (L70) for a minimum of 120,000 hours as measured per the Illuminating Engineering Society of North America (IESNA) standard LM-79-08, Electrical and Photometric Measurements of Solid-State Lighting Products.
 - xii). All minimum lighting levels per APTA shall be maintained at the end of the 120,000-hour period.
 - xiii). RGB LED luminaires shall have a lumen maintenance of 70 percent (L70) for a minimum of 80,000 hours.
 - xiv). The Contractor shall propose designs that include automated scenarios to address the known reduced light output as components age.
 - xv). As Amtrak passengers occupy trains for extended periods, simply increasing the initial light output with no age compensation to address end of life degradation is not acceptable.
 - xvi). LED luminaires shall be provided with sufficient heat sinks capable of keeping LED junctions and associated electronics below 125°F, regardless of summer ambient temperature and continuous operation.
- b). Independent Power Source

i). General

- (1) There shall be two independent power sources on each car to provide maximum emergency lighting availability on each car.
- (2) Each power source shall be at least 20 feet apart from each other to avoid a single point failure in case of a catastrophic accident that could disable all emergency lighting on the car.
- (3) Lighting fixtures, including HPPL signage backlighting fixtures, shall alternate power sources over the entire length of the car to maximize availability of emergency lighting according to 49 CFR 238.115(b)(1) equivalent level of safety.
 - (a) It is acceptable to exceed the APTA specified distance between independent power source and the light fixtures that it powers as long as the 49 CFR 238.115(b)(1) equivalent level of safety is achieved with the overall arrangement.
- (4) Independent Power Sources shall have their own dedicated equipment enclosure for improved maintainability.
- (5) Independent Power Source risks must be included in the hazard analysis at Intermediate Design Phase.
- (6) There shall be power source charge level indications to quickly show emergency lighting readiness to operations inspectors and maintainers preparing cars for passenger service.
- (7) Power source charge level shall be reported on both the lighting power source enclosure with status LEDs, and the car network to the diagnostic system.
- (8) Self-test functions of the independent power sources shall consider time required to function test the controller, validate power source capacity, and display to the maintainer estimated time for self-test completion.
- (9) It shall be possible to self-test power sources either one at a time, or both simultaneously to minimize test duration for maintenance personnel.

ii). Battery-Based Power Source

- (1) Batteries shall comply with all requirements in APTA PR-E-S-013-99.
- (2) Battery and Battery Management Charging System can be combined into the same enclosure, but they cannot be combined with other lighting controls that have longer periodic maintenance intervals.
- (3) There shall be deep discharge protection for the battery.

- (4) Battery Management System failures and battery venting risks must be considered when designing the initial equipment enclosures at Intermediate Design Phase.
- iii). Capacitor-Based Power Source
 - (1) The required emergency lighting that has an alternate back-up to the vehicle batteries may be supplied by capacitor-based lighting.
 - (2) The capacitors must be rated for a minimum of 500,000 charge cycles.
 - (3) Capacitor terminals shall be covered to protect shorting and shall be connected to fixtures through connectors.
 - (4) The capacitor-based power source for emergency lighting shall have a label located on the side of the unit exposed for service that includes the following information:
 - (5) OEM name and address
 - (6) OEM part number — revision/modification level and date
 - (7) Date of manufacture
 - (8) Unit serial number
 - (9) Voltage and capacity rating
 - iv). Extended Emergency (OPTION)
 - (1) The independent power source shall increase the required time to power the emergency lighting system to a minimum of eight (8) hours after loss of 480VAC HEP power.

13.12 Housings, Lenses and Diffusers

a). General

- i). The overhead light assembly shall be designed for luminary replacement from below. The hinged light lens shall swing down allowing easy luminary replacement.
- ii). No material shall suffer any loss of performance when exposed to environmental conditions specified in Amtrak Specification 963 or exhibit degradation of properties (including color) under long-term exposure to ultraviolet light.
- iii). Lighting fixtures shall have lenses designed to aid in light distribution, prevent glare, permit easy luminary cleaning and facilitate luminary replacement.
- iv). Fixtures equipped with lenses shall have a one-piece polycarbonate lens, either clear or translucent white, uniform in color and smooth on the exposed

side, which will provide the specified intensity of illumination on the reading plane, while diffusing the light to illuminate adjacent wall and ceiling surfaces, increasing the overall brightness level in the interior of the car.

- (1) The lens shall be mounted on a hinged bezel and shall be secured with captive fasteners.
 - v). The lenses shall project light with an even brightness without patterns and shall have a smooth surface on all sides and edges that are open to the passenger seating area to avoid injury.
 - vi). Tamper-proof fasteners shall retain door to the housing.
 - vii). A neoprene foam gasket around the lens assembly shall make the joining of door and reflector dust-resistant and rattle free.
 - viii). The diffuser lens shall be removable for replacement.
 - ix). The lenses shall be easily replaceable without having to disassemble the light fixture and shall be made of an approved Ultraviolet (UV)-stabilized polycarbonate and meet the Flammability, Smoke Emission and Toxicity requirements specified in Chapter 19.
- b). Apparent Light versus Illumination:
- i). The primary function of lighting fixtures is to provide controlled illumination for the safety, convenience and comfort of the passengers and train crew.
 - ii). Lighting fixtures produce illuminating and apparent light.
 - (1) Illuminating light projects or otherwise illuminates objects and areas. The illumination levels for those areas are defined within the specification according to the activities of those areas or other specific needs.
 - (2) Apparent light is the illumination that the passenger or crew person sees of the fixture itself.
 - (3) Lighting fixtures used for normal lighting (non-emergency) in continuously occupied passenger and crew spaces shall be designed so that the apparent light is unobtrusive to passengers. This is especially critical when cars are in Quiet Car Mode.
 - (4) Fixtures shall be lensed and baffled to prevent the apparent light from being annoying or distracting to passengers and crew.
 - iii). Lighting shall be designed in accordance with APTA Standards to maintain charge for HPPL signage and LLEPM under normal lighting.
 - iv). Lighting shall be designed to eliminate reflected glare beyond the intended illumination zone.

- v). All fixtures in continuously occupied passenger and crew spaces must be shown during design review to not have normal direct view of the light source (LED array) or diffusor.

13.13 Controls

a). Lighting Control Human Interface General

- i). All lighting controls shall operate on an individual car basis, under the control of the train crew.
- ii). Amtrak accepted method of easily providing various levels of interior car illumination by the train crew shall be provided.
- iii). The exception to the train crew lighting controls are the bedroom, nest and roomette controls described in Section 13.6.c). i).
- iv). The car lighting controls shall be located in the switch locker located within the electric locker.
- v). Lighting modes as described in Section 13.5 shall be selectable using the car network HMI to control the lights on a per-train level. Transitions between lighting modes shall have an Amtrak adjustable PTU parameter for time duration.
- vi). There shall be an individual override switch on each car to force a lighting mode.
- vii). The car network may also be used with consideration for priority levels with physical switches and failure conditions defaulting to conservative operating modes.

b). Lighting Control Override Switch

- i). Each car shall have a manual lighting control override switch with positions for Quiet, Night, Auto, and Cleaning as described in Section 13.5.
- ii). The switch positions shall be monitored by the diagnostic system and fault information messages when a train-level command and car override switch position are not the same.
- iii). Cleaning mode position shall be momentary, and all other positions shall be maintained.
- iv). Cleaning mode shall have a software parameter time setting adjustable by Amtrak.
- v). An additional reading light test switch or feature shall be provided such that all reading lights in a car can be turned on and off at once from the central controls.
- vi). Controls and switches designated for crew operation shall be located on electrical panels separate from devices designated for maintenance

operation such as circuit breakers. See Section 15.11 Electrical Panels for additional requirements.

- vii). All lighting shall be circuit breaker protected. Lights identified for on/off control shall have an on/off switch in addition to the circuit breaker. Controls shall be housed in the electric locker, except as listed below, where local controls shall be provided:
 - (1) Each reading light shall have an on/off switch located adjacent to the reading light.
 - (2) Each reading light at a wheelchair location shall have an on/off switch located in accordance with the requirements of ADA.
 - (3) Electric and Utility lockers shall have automatic light magnetic proximity switches located inside the locker adjacent to the entry door.
 - (4) Selected lighting circuits in the food service area shall have on/off switches. See Chapter 16 for details.

c). Adaptive White Lighting

- i). Adaptive lighting shall have the ability to automatically adjust light intensities based on real-time measurements from photocell sensors located either in the passenger interior or exterior of the car.
- ii). There shall be at least two (2) photocell sensors used to determine outside ambient conditions.
 - (1) Photocell sensors shall be used to adjust interior light intensity based on outside ambient conditions.
 - (2) Adaptive light control shall consider weather conditions, infrastructure or geographical terrain that could bias some or all photocell sensors.
 - (3) Light adjustments and transitions shall have Amtrak adjustable PTU settings for intensity and time duration to optimize passenger eye comfort.
 - (4) Details shall be submitted to Amtrak for approval during design review.
[CDRL 13-14]
- iii). Interior photocell sensors can be used to control interior light intensity and address the age compensation requirement of LEDs in Section 13.11.a).
- iv). There shall be a switch for auto on / off control to override and disable adaptive lighting by the train crew.
- v). Failure modes of adaptive lighting must be considered and have no impact to emergency lighting functionality.

d). Lighting Coordination with Passenger Boarding

- i). When the side doors are opened for passenger boarding, the door open signal shall be available to the lighting controller to activate specific lighting zones for passenger visual aid.
- ii). The lighting controller shall be able to activate the following lighting zones from the time the side doors are opened, and then returned to normal after a time adjustable by PTU.
- iii). The following lighting zones shall be able to have accent lighting effects activated:
 - (1) Vestibule lighting
 - (2) Baggage tower area lighting
 - (3) Main stairway lighting

13.14 LLEPM and HPPL Emergency Signage

a). General

- i). A low-level exit path floor marking system shall be installed in the car in compliance with APTA Standard PR-PS-S-004-99.
- ii). Light intensity for emergency lighting levels shall take color temperature into consideration to allow HPPL material to be sufficiently charged by emergency light levels (ref APTA PR-PS-S-004-99 table 1).
- iii). The system shall operate in conjunction with the emergency lighting system. Details shall be submitted to Amtrak for approval during design review.
[CDRL 13-15]

b). LLEPM and Emergency Signage Backlighting

- i). For all HPPL signage, each HPPL sign shall use backlighting instead of overhead lighting to charge the HPPL material.
- ii). HPPL backlighting shall be functional during all lighting modes.
- iii). A preliminary HPPL backlighting concept arrangement **[CDRL 13-16]** shall be submitted at Preliminary Design Phase to identify interior supplier integration requirements early in the design phase.

13.15 Minimum Illumination Levels

- a). Light levels shall be reviewed and finalized during design review.

Figure 13-1: Minimum Illumination Levels

Area	APTA REF	Measured At	Illumination Levels in Foot-Candles			
			APTA LEVELS	Normal Lighting	Quiet Car Lighting	Standby Lighting
General Overhead	6.3	45 plain	20	10	5	5
Reading Lights	6.3	45 plain	20	20	20	20
Aisleway Lighting	5.5	Floor	5	5	5	5
Vestibules, Steps	5.1	Floor, Threshold	5	10	10	5
Low-Station Platform	5.1	Perpendicular to Threshold 3 feet away at each step height	2	5	5	5
End Passageway / Diaphragm / Gangway Area	5.1 / 5.4	Floor	5	10	10	5
Toilet Room	5.6	Mirror	30	30	30	10
Toilet Room	5.6	Area	15	15	15	10
Food Service Area	10.3	Table Area	15	15	15	5
Passenger Service Counter Area	10.3	Counter	20	20	20	10
Kitchen General		30 inches above floor		20	20	5
All Food and Beverage Displays		Each shelf		20	20	5
All Food Preparation Area (FDA Food Code 2022 section 6-303)		Counter		50	50	5
Elevator Floor				20	20	5
Electric Locker	5.7	All signage		20	20	5
Utility/Equipment Room		Floor, All signage		20	20	5
Utility Closet	5.8	Floor, Shelves		5	5	5
Bike/ Luggage Rack Area	11.3	Floor	5	10	5	5
Luggage Rack Tower	11.3	At aisle on Floor	5	10	5	5

13.16 CDRLs

CDRL	Description	Due
CDRL 13-01	Interior and Exterior Lighting Plan	30 days prior to Lighting PDR
CDRL 13-02	Drawing of lighting arrangement for each car type	30 days prior to Lighting IDR
CDRL 13-03	General arrangement and locations concepts for white LEDs and Accent RGB lighting	30 days prior to Lighting PDR
CDRL 13-04	Identification of standby and/or emergency lighting fixtures	30 days prior to Lighting PDR
CDRL 13-05	Details of lighting fixtures, luminaries, circuit breakers, controls and switches.	30 days prior to Lighting IDR
CDRL 13-06	Required charging light levels for HPPL and HPPL Emergency markings	30 days prior to Lighting IDR
CDRL 13-07	Physical examples of each lighting fixture	At FDR
CDRL 13-08	Certification to Amtrak that the car's lighting system meets all standards and regulations	30 days prior to Conditional Acceptance
CDRL 13-09	Suggested Light Color Plan	30 days prior to Lighting PDR
CDRL 13-10	Emergency Lighting Plan	30 days prior to Lighting IDR
CDRL 13-11	Demonstration and Written Certification of Compliance for Emergency Lighting	30 days prior to Complete car FAI
CDRL 13-12	Toilet Room artwork for labels	30 days prior to Lighting PDR
CDRL 13-13	Accent RGB light user interface details	30 days prior to Lighting IDR
CDRL 13-14	Photocell sensor details	30 days prior to Lighting PDR
CDRL 13-15	LLEPM and HPPL Emergency signage details, including integration	30 days prior to Lighting IDR
CDRL 13-16	Preliminary HPPL backlighting concept arrangement	30 days prior to Lighting PDR

* End of Section 13 *

Amtrak Long Distance Bi-Level Fleet Replacement

Technical Specification

14. Communication System

Revision 1

Table of Contents

14.1	Overview	14-1
14.2	General Requirements	14-2
14.3	Public Address/Intercom (PA/IC) System	14-6
14.4	OTIS Capability	14-13
14.5	OTIS Requirements.....	14-18
14.6	Provision for Wireless Internet.....	14-40
14.7	Information Technology and Architecture	14-53
14.8	Ethernet Train Backbone (ETB) and Ethernet Car Network (ECN)	14-57
14.9	Electromagnetic Interference.....	14-62
14.10	CDRLs.....	14-62

14.1 Overview

a). System Manufacturer

- i). This chapter describes the system requirements for the on-board communication system to be provided on each car of the supplied fleet.
- ii). Amtrak is in-process of defining Televic LiveCoM Suite or progeny as their enterprise-wide supplier of choice for all on-board communication systems.
- iii). The contractor shall deliver a Televic system that complies with the requirements of this specification.

b). System Composition

- i). The communication system consists of:
 - (1) the Public Address / Intercom (PA/IC) system, including
 - (a) Public Address Speakers
 - (b) Public Address Amplifiers
 - (c) Attendant call system
 - (d) Passenger Emergency Intercoms
 - (e) PA/IC Control Stations
 - ii). the Onboard Train Information System (OTIS)
 - iii). A reservation display system (including seat, compartments, and other passenger reservable areas)
 - iv). An electronic door lock system
 - v). A video surveillance system
 - vi). the Ethernet Train Backbone (ETB)
 - vii). and the Ethernet Car Network (ECN).

c). System Functionality

- i). These systems have discrete functions that are extensively integrated to provide a comprehensive communication system within each car and between the car and other cars in the assembled consist.
- ii). This design shall be based on modern state of the art technologies and shall be built with an extensible architecture that shall both interface with systems that may already be in use in any existing rolling stock and in Amtrak's existing wayside environment, as well as support on-board systems, rolling stock, and wayside systems that may be added in the future.

- iii). The communications system shall comply with the requirements of APTA Standard PR-PS-S-001-98 and all applicable federal and state regulations.
 - (1) In the event APTA standard couplers, air brake hoses, or passenger car Head End Power/Communications/locomotive MU control electrical trainlines are used inter-car, the connections must meet all applicable AAR, APTA, and Amtrak standards.
- iv). The car's ECN and the train's ETB shall be capable of multiple functions, including providing a data backbone for Ethernet-based communication within each car and between cars that is to be used for destination sign and announcement control, diagnostics, video surveillance data transmission and download, and real-time health monitoring of on-board systems and components.
- v). The consist ETB and ECN shall facilitate data transfer between the on-board systems of the car and train and wayside communication systems through 4G and 5G multi-modem, multi-carrier routers implemented as the Data Communication System (DCS).
- vi). Consist Length
 - (1) Consists are typically configured up to 1870 ft in length.
 - (2) All trainset functions shall operate per the standards of this specification within this train length range.
 - (3) Trainline functions may operate at reduced levels at consist lengths greater than 1870 ft based on an Amtrak approved technical justification that includes revised limits.

14.2 General Requirements

a). General

- i). The OTIS/PIS shall provide the passengers with both visual, audible, and digital information as configured and programmed by Amtrak such as the train destination, present station, next station, pre-set messages, train consist arrangement, car and consist information, emergency messages and visual graphics, including advertising.
- ii). The information shall be provided through the interior and exterior signs, through interior and exterior speakers, through the inductive audio loop system, through Bluetooth LE Auracast broadcasts, and through other digital networked connections as required by Amtrak.
- iii). The OTIS/PIS shall be a fully automated system, with the capability for overrides and adjustments by train crew and Amtrak wayside operations.
- iv). Once the system is activated, through the selection of a pre-programmed route by train crew or an Amtrak wayside operation, it will automatically establish train location through the Global Positioning System (GPS) and

- sequentially display and announce the upcoming stations at programmed locations.
- v). The system shall receive speed signals from the Ethernet Car Network to facilitate continued operation during times when GPS is not available, and shall be capable of receiving train crew input to resynchronize train location.
 - vi). The system shall implement secure APIs exposed to Amtrak that allow for simultaneous voice, textual, graphical, diagnostic and test message control of passenger facing communication system displays via the 4G/5G cellular connection. The APIs shall include the capability for Amtrak to update, control, and trigger content on individual screens used throughout the communication system based on live feeds of information from on-board and wayside sources, which shall be configurable by Amtrak. These feeds shall enable a variety of uses, including, but not limited to:
 - (1) Live News
 - (2) Live weather
 - (3) Menu and on-board inventory updates
 - (4) Consist status
 - (5) Destination information
 - (6) Scenic information
 - vii). The OTIS/PIS shall support carborne Internet Service Provider (ISP) for Private Internet connectivity via a multi-modem multi-carrier 4G and 5G mobile access router, an Ethernet Train Backbone (ETB) between cars, and Passenger Wi-Fi system in each car.
 - viii). The network and software architecture, design, and configuration of the equipment identified in this Chapter shall be extensible by Amtrak, facilitating the addition or replacement of additional vehicle switches and end devices throughout the life of the vehicle through exposed APIs implemented at each device supplied as a part of these requirements which facilitate the interaction with Contractor supplied communication components.
- b). EMI/EMC Design Requirements
- i). The design and installation of the communications system shall ensure that it functions as intended, without interference to or from any other electronic equipment on the trainset.
 - ii). It shall comply with the requirements of the Federal Communications Commission (FCC) for Class A radiation standards, the requirements of APTA Standard PR-E-S-010-98 and Chapter 19 for materials and workmanship.
- c). Fault Tolerance and Recovery

- i). The car and train level components of the system shall be fault tolerant, so that failure of one item shall not impair normal operation of the remainder of the system, and that any single point of failure does not result in good cause to remove the train from continued revenue service.
 - ii). To accomplish this, it is expected that multiple communications controllers will be required per train, and that multiple PA Amplifiers will be required per car, and that diagnostic information will be available through multiple controllers.
 - iii). The Contractor shall identify the fault tolerance capabilities, recovery time, and user interaction required to maintain system operation. **[CDRL 14-01]**
 - iv). Momentary Head End Power (HEP) power outages shall not cause the system to require any reset, and upon the loss of power for any reason while executing a journey, the system shall return to its previous route and location without re-programming or reconfiguration by train staff.
- d). Public Address/Intercom (PA/IC) System Component Locations
- i). PA / IC control stations shall be located at least in the following areas, to be confirmed based on proposed car design and layout:
 - (1) At least one located in each car that is paired with a control terminal
 - (2) One located at each crew area, including:
 - (a) Conductor's office, paired with a control terminal
 - (3) Located at each serving counter area
 - (4) One located at each boarding area, paired with a passenger accessible control terminal
 - (5) One located at each crew rest area, paired with a control terminal
 - ii). Speakers shall be provided throughout all cars
 - iii). Speaker zones shall be located in the following areas of each car:
 - (1) Interior public passenger areas
 - (2) Individual zones in each private passenger compartments such as sleepers and roomettes
 - (a) Volume control shall be provided in each private passenger compartment, which can be overridden by the selection of the Interior – Override zone.
 - (3) Exterior "left" zone
 - (4) Exterior "right" zone

- iv). IP Based PA amplifier
 - (1) A minimum of two shall be provided in each car to provide redundancy of audible broadcasts
- v). Inductive Loop Amplifier
 - (1) Inductive loop amplifiers shall be provided on each car to provide passengers with assistive listening devices in passenger areas access to public PA announcements for that car
- vi). Interface to OTIS system
 - (1) The PA / IC system shall be controlled through OTIS Control Units throughout the train
- vii). Interface to analog trainlines
 - (1) Each car's Public Address / Intercom shall support interface to analog trainlines
- viii). Interface to Ethernet Train Backbone
 - (1) Each car shall interface with a redundant Ethernet Train Backbone to support the functions of the Communication system and its components.
- e). OTIS System Components
 - i). The Contractor shall provide the following equipment:
 - (1) Exterior destination signs; (all cars)
 - (2) Interior graphical displays; (all cars)
 - (3) Interior graphical displays with integrated control terminal; (all cars)
 - (4) OTIS Control Unit (OCU); (all cars)
 - (5) Data Communication System (DCS); (all cars)
 - (6) GPS; (all cars)
 - (7) Interface to Ethernet Train Backbone
 - ii). Some consolidation of functions may occur between PA and OTIS but the combined system must meet the requirements herein.
- f). Cellular Telephones
 - i). The Contractor shall ensure that mobile cellular telephones can operate reliably inside all cars within each car, under all on-board equipment

operating conditions and at all locations along the Amtrak operating system, provided that the necessary external facilities have been installed by others.

- ii). The Contractor shall include appropriate considerations taken as a part of the carbody design and/or window design to limit the impacts on cellular reception inside the vehicles from car construction, and from electrical and electronic equipment integrated into the vehicle.
- iii). At PDR, the Contractor shall submit for Amtrak approval a plan for minimizing the attenuation based on car construction, such as using etched window coatings in vehicle glazing, RF transparent car-body components, or other approved approach.
- iv). The Contractor shall submit a plan identifying the approach to reducing the attenuation of the car-body, on-board equipment, and glazing impact on cellular telephone reception to Amtrak for review and approval prior to PDR **[CDRL 14-02]**.

14.3 Public Address/Intercom (PA/IC) System

a). Public Address (PA) System General Requirements

- i). Each car in the trainset shall be equipped with a fully digital, IP Ethernet based PA system.
- ii). The system shall permit the train crew to provide a manual PA announcement to the passengers and allow it to be directed to loudspeakers on only the local car interior, to the interior of all cars in the trainset and/or to the exterior speakers of all cars in the trainset.
- iii). The PA system shall also provide a means for a train crewmember to communicate by voice in an emergency situation to persons in the immediate vicinity of the trainset.
- iv). The PA system shall provide Amtrak's Consolidated National Operations Center (CNOC) with the capability to control the Public Address System, including making audio, visual, video and graphical announcements for emergencies, service disruptions, and otherwise as commanded by authorized Amtrak personnel.
- v). PA Amplifier Requirements
 - (1) Each PA amplifier shall have power supplied directly from the car low voltage battery circuit and protected by a dedicated circuit breaker.
 - (2) The PA amplifier shall interface with the OCU and with the control terminal over the DTL and drive the car speakers whenever audio messages are generated.
 - (3) The PA amplifier shall have a power output capacity sufficient to drive all the speakers on the car at the nominal speaker output power plus

25% spare capacity. The same PA amplifier unit model shall be installed on all car types.

- (4) The PA system (from the input to the microphone to the output of the interior speakers) shall have a 90% intelligibility rating when tested according to ANSI Standard S3.2-1989 (R1999) and shall have the following performance characteristics for all modes of operation, including manual and automated digitized announcements:

Frequency Response: ± 5dB from 250 Hz to 8 kHz

Total Harmonic Distortion: Less than 1%

Hum or Buzz: Signal-to-noise ratio shall be greater than 40dB

- (5) The PA amplifier shall incorporate a volume control adjustable only with the use of the Portable Test Unit (PTU) and through administrative access provided via the wayside systems. The sound level from the car's speakers shall be uniform within ± 5dB at all passenger locations.
- (6) The PA amplifier shall be a programmable amplifier.
- (7) The PA system shall have a Day/Night mode. The Day mode will be in normal operation. The Night mode will decrease the output by 8db. This mode should be able to be triggered by PA Control Panels, OCU, and car control terminals. The setting shall be overridable by individual passengers in sleeper rooms through the Passenger Compartment Control Unit.
- (8) The PA amplifier unit shall incorporate at a minimum, the following indicators on the front panel (alternate designs may be presented for Amtrak approval):
 - (a) On-Off LED – indicates when device is on and power is present
 - (b) Fault indicator LED – indicates when a fault has occurred with PA Amplifier operation

- vi). PA and intercom systems shall be provided with sufficient battery capacity to provide for a minimum of 90 minutes of operation following loss of HEP. See Chapter 15.

- (1) Intermittent communication shall be considered equivalent to continuous communication during the last 15 minutes of the 90-minute minimum period for the purposes of Direct Current (DC) load budget calculations.

b). PA/IC Control Station Functional Requirements

- i). Each PA/IC Control Station shall be IP/Ethernet based

- ii). Each PA/IC Control Station shall be powered via PoE via the Ethernet Car Network
- iii). Each PA/IC Control Station shall allow the selection of audio zones, to be proposed at PDR and approved by Amtrak. Zones shall include, at a minimum:
 - (1) Exterior Left side
 - (2) Exterior Right side
 - (3) Interior
 - (4) Interior – local car
 - (5) Interior – Override
 - (6) All speakers
 - (7) Other specific channels as configured by Amtrak onboard staff (such as, Rail and Trails, or other secondary audio programming channels).
- iv). Each PA/IC Control Station shall be equipped with a handset.
- v). PA/IC Control Station Handset Requirements
 - (1) Handsets shall be equipped with a push-to-talk switch.
 - (2) The handset cord shall be equipped with an adequate strain relief fitting where it is attached to the handset.
 - (3) A handset holder shall be provided with each handset for storage when not in use.
 - (4) Each Handset should be attached to the PA Control Station the standard Amtrak microphone and handset connector plugs (p/n 10623456) to facilitate quick replacement when damaged.
- c). Interior and exterior speakers
 - i). Each vehicle shall be equipped with a sufficient number of speakers located throughout the interior of the car to provide a uniform audio level throughout each passenger compartment.
 - ii). The interior speakers shall be installed for replacement from the front, and sufficient length shall be provided in the wiring for this purpose.
 - iii). Each vehicle shall also be equipped with weatherproof exterior speakers installed on the exterior of the car sides, one speaker near each set of doors to enable the broadcasting of messages to passengers on the platform from the PA system from within the car.

- iv). The speakers shall be phased so that when the primary is connected to the distribution network, all speaker cones shall move in the same direction at the same time.
 - v). The exterior speakers shall be fully weatherproof, mounted behind a strong, replaceable stainless-steel grille resistant to thrown objects and be immune to the chemicals and detergents normally used during vehicle washing.
 - vi). There shall be no feedback between car speakers and the control station handset when the public address system is in use.
 - vii). Speakers housed in private passenger compartments shall include a means for a passenger to control the volume on non-overridden audio announcements.
 - viii). Through the content management tool, individual announcements shall be marked as normal messages or override messages – such that routine station announcements could be muted, but special messages indicating critical information will play at a normal volume despite individual volume control.
 - ix). Through the PA/IC Control station, train staff shall be able to select the type of manual announcement.
- d). Inductive Loop
- i). Each car shall be equipped with an audio inductive loop antenna and transmitter system, to allow receipt of announcements by passengers wearing hearing aids.
 - ii). The system shall be integrated with the OTIS and PA systems to broadcast interior public messages that are broadcasted in the area of the inductive loop.
 - iii). The system shall be ruggedized for the railroad environment and shall be a high output current design (no less than 10 Amps RMS), feature a high frequency gain potentiometer, feature metal loss correction, operate on vehicle nominal DC voltage, and include status LEDs for status information.
 - iv). The solution shall meet all appropriate certifications for both Rail and Hearing Loop technology including, but not limited to EN-50155, EN-50121-3-2, EN-45545-HL2, IEC-60118-4, and IEC-62489.
 - v). The solution design and implementation plan should align to BS-7594 or EN-303-348 and testing should be completed to verify that:
 - (1) Background magnetic noise is minimized
 - (2) Magnetic Field is strong enough to provide full car coverage while minimizing interference with RF on the train (Wi-Fi, Mobile Voice and Data, etc.)
 - (3) Frequency Response is appropriate to T-Switch capable equipment.

- vi). The inductive loop shall cover all areas of the passenger compartments.
- e). Bluetooth LE Broadcast
 - i). Each car shall be equipped with the capability to broadcast audio and pertinent passenger train information via Bluetooth based transmitters.
 - ii). All interior messages shall be broadcast via Bluetooth Auracast technology on a primary channel.
 - iii). The OTIS system shall be programmable with alternative audio tracks – synchronized to be played back based on train position - that shall be broadcast on additional Auracast channels.
 - iv). These additional program channels may be used to provide additional translations for audio announcements, or scenic commentary.
 - v). Additional live PA audio channels shall be made available via Auracast when configured by onboard train staff to facilitate secondary live channels for specific programming, such as to enable transmissions of Amtrak's Rails & Trails programming throughout the train, and to support transmission to passengers who are Deaf or hard of hearing.
 - vi). Bluetooth LE data channels shall enable broadcasting of a selection of triggers of passenger announcements to facilitate applications running on passenger devices to receive train information via the Passenger network, and relay information displayed on the interior displays.
 - vii). The Bluetooth LE broadcasts in each car shall enable beacon technology to facilitate micro-location within a train consist and train car. Amtrak shall have the capability to adjust beacon messaging. The contractor shall demonstrate that enough beacons have been implemented in each car and on each level to provide positioning within 8 feet when using triangulation techniques on consumer handsets.
- f). Two-way crew intercommunications (intercom)
 - i). The crew intercom (IC) system shall be designed to allow the crew to communicate with other personnel on the train.
 - ii). For IC communications between crew members within the train consist, the IC mode must be selected on the PA/IC Control Station.
 - iii). To signal other crew members that an IC call has been requested, the PA/IC Control Station should give visual and audio feedback until another handset has been connected to IC by lifting it off the receiver and selecting IC mode.
 - iv). Audio and visual messaging indication through the interior passenger compartment speakers and interior messaging signs shall be capable of displaying and alerting train crew to a waiting intercom request through configurable means available to Amtrak.

- v). At PA/IC Control Stations with adjacent Control Terminals, it shall be possible for train crew to communicate with specific IC stations, with IC stations on specific cars, or with specific connected crew app users.
- vi). The intercom communication on a train shall support one to one and party line communications between PA/IC Control Stations and crew app users.
- g). Passenger Emergency Intercom (PEI)
 - i). Cars shall be equipped with a passenger emergency intercom system that conforms to 49 CFR Section 238.121 and provides a means for passengers and crewmembers to communicate by voice with each other in an emergency situation.
 - ii). A minimum of three PEIs shall be provided on each two-level car.
 - (1) At least one PEI station that is accessible to passengers without using a tool shall be located in each half of each vehicle on the upper level.
 - (2) At least one PEI station that is accessible to passengers without using a tool shall be located on the lower level of each vehicle.
 - iii). The location of each PEI station intended for passenger use shall be conspicuously marked with luminescent material and legible and understandable operating instructions shall be posted at or near each such intercom. Instructions shall include indication that the calls may be recorded.
 - iv). PEIs shall trigger event recording on the NVR in order to mark the section of video recordings relevant to the PEI call.
 - v). Amtrak, through a configurable setting, shall be provided the ability to enable or disable the NVR recording of the two-way audio calls synchronized with the video of the closest camera to the PEI.
 - vi). PEIs shall be configurable by Amtrak, such that calls may be routed and answered by one or more call center locations that are not on the train, given there is sufficient bandwidth available from the Data Communication System. The PEI configuration shall include whether the calls simultaneously ring to the onboard staff or to the wayside, to the onboard staff only, to the wayside only, or to the wayside only if the onboard staff do not answer within a predefined time limit.
 - vii). PEI calls shall be configurable to be annunciated by PA tone, through crew-app notification, and on the display screens including passenger graphical displays, control terminal displays, crew compartment control panels, and remotely. The annunciation shall be configurable to include car number, road number, relative position in train based on display location, and location in the vehicle.
 - viii). A duress button shall be placed in publicly accessible restroom, which shall provide a similar indication as a PEI as described above.

ix). PEIs shall be full duplex.

h). Attendant Call System

i). Each sleeper compartment, and at each entrance of each interior lift, shall include means to initiate an attendant call to request services from train staff.

ii). Status of the attendant call (including pending call, answered call, and call on hold) shall be indicated through visual and audible means at the location requesting the call. The audible means, including sound and repetition, shall be configurable by Amtrak.

iii). When an attendant call is answered, the call button shall indicate the call has been answered, and a dedicated microphone "on" indicator shall be illuminated in the calling compartment. Microphone circuitry shall ensure the "on" indicator is illuminated any time the microphone is listening, and include a means for passengers to mute the microphone.

iv). Attendant call LED indicators on the exterior of the compartments with pending attendant call requests shall be illuminated.

(1) This may be implemented through the use of a dedicated indicator on the reservation display system for the compartment.

v). The system shall be capable of handling multiple attendant call requests, indicating the number, order, and location of all pending calls.

vi). Status of attendant calls shall be made available on the Control Terminals, through the crew app, and to Amtrak systems on the wayside.

vii). Attendant calls shall be selectable and answerable by PA/IC Control Units, through the crew app, or by Amtrak systems on the wayside.

viii). Public restrooms shall have a one-way attendant call request without audio capability for the purpose of indicating when a restroom requires staff attention.

ix). Each Control Terminal, and through APIs provided by the OTIS, each Crew App Instance, shall include the capability to configure the attendant call system to:

(1) select one or more compartments, lifts, and cars to receive calls for that station

(2) silence all attendant calls for that station

(3) Compartments or lifts that are not manually assigned to one station shall ring all stations.

(4) Unanswered attendant calls shall ring through to other stations after a Amtrak configurable period of time.

- i). PA Wiring
 - i). PA/IC Control Stations and PEIs shall be connected to the Otis Control Unit (OCU) via the Ethernet Car Network (ECN).
 - ii). The preferred method of powering PA/IC Controllers and PEIs is via PoE, alternative arrangement shall be submitted for approval by Amtrak.
 - iii). The OCU should be able to communicate between cars within the trainset using the Ethernet Train Backbone. The OCU shall also include an analog fallback that interfaces with the analog trainline.

14.4 OTIS Capability

- a). General Requirements
 - i). The OTIS shall be capable of full graphic, template, and video display including advertising through the interior signs.
 - (1) The OTIS shall provide the passengers with both visual and audible information such as:
 - (a) the train destination
 - (b) the car number
 - (c) the consist arrangement, including current car and coupled cars in a graphical format showing train layout and amenities
 - (d) present station
 - (e) next station
 - (f) dynamic route map
 - (g) pre-set messages
 - (h) emergency messages
 - (i) visual graphics
 - (j) advertising.
 - (k) Time and date
 - (l) Current speed
 - ii). The information shall be presented through the interior and exterior signs and the PA system as configured by Amtrak.
 - iii). Configuration of the OTIS graphical displays shall be through a template system that shall support the use of:

- (1) All vehicle diagnostic network variables (such as consist arrangement, system status, and speed)
 - (2) Communication system variables (such as present station, route, a location information)
 - (3) External feeds supporting ground-side integration capabilities for content and data so that information from Amtrak enterprise data sources may be delivered from the wayside via the Data Communication System, stored onboard, and displayed on the train information displays.
- iv). The OTIS shall be a fully automated system, with manual override feature. Once the system is activated, it will automatically establish train location through the Global Positioning System (GPS) and sequentially display and announce the upcoming stations at programmed locations.
- v). It is the Contractor's responsibility to supply equipment capable of operation in the rail environment consistent with Amtrak Specification 963 and EN 50155:2021.
- (1) All individual components used in the fabrication of the equipment shall meet or exceed the requirements of the above standards.
- vi). The Contractor shall submit documentation and calculations for all individual components, and for the system as a whole, for review and approval by Amtrak at the Preliminary Design Review (PDR) to demonstrate the conformance to the requirements in this technical specification and referenced standards. **[CDRL 14-03]**
- vii). The equipment shall meet the requirements of IEEE Standard 1477 and all FRA, AAR and ADA applicable rules, regulations and guidelines.
- viii). The PA function of the carborne OTIS system shall utilize only digital communication signals between OTIS equipped cars but be able to generate and receive analog audio signals from other cars as specified.
- ix). OTIS Equipment Power Requirements
- (1) All carborne OTIS equipment shall be powered from the car's DC power supply.
 - (2) All equipment shall function normally and provide the specified performance for all supply voltage variations as required by EN50155 and based on the DC power supply design.
 - (3) Partial shutdown after load shed/drop of the equipment is acceptable, followed by automatic restarting as the voltage returns to the specified levels.
 - (4) No permanent damage shall be caused to the equipment following these conditions. See Chapter 15 for load shed/drop schedule.

- (5) All carborne OTIS equipment shall be protected from damage from a polarity reversal of the voltage supply, and power supply shutdown and immediate reapplications.
 - (6) All carborne OTIS equipment shall have integral power conversion and conditioning. External power supplies are not acceptable.
 - (7) All carborne OTIS equipment shall be protected by external dedicated circuit breakers located on the car low voltage control panel.
 - (8) The circuit breakers shall be sized to protect the smallest size wire directly connected to the protected circuit.
 - (9) Fuses shall not be accepted either outside or inside the equipment.
 - (10) Internal circuit protection shall not be used, but if unavoidable must be a re-settable type circuit protection approved by Amtrak.
 - (11) All low voltage power supply inputs shall be isolated from ground.
 - (12) All supply inputs shall be adequately filtered to minimize current and voltage ripple.
 - (13) All equipment enclosures and shock-mounted equipment shall be grounded in accordance with APTA Standard PR-E-S-005-98.
- x). OTIS Equipment Connectors
- (1) All equipment shall be connected to the Ethernet Car Network via M12 connectors.
 - (2) All connectors shall be located in the front of the equipment or other easily accessible locations for quick connection and disconnection.
 - (3) All connectors of the same type and size, with the exception of Ethernet M12 connectors, shall be keyed to avoid insertion into the incorrect location.
 - (4) Connectors shall be identified in accordance with the schematic designation. All connector types shall be submitted to Amtrak for approval prior to preliminary design review.
- xi). OTIS Equipment Maintainability
- (1) Removal and installation of any component shall not require the removal of any other equipment.
 - (2) Replacement of any Communication system component of the same type shall not require manual re-configuration. This shall be implemented through car-side coding connectors, dynamic assignment of IP addressing from car network switches, or other method approved by Amtrak.

- (3) The enclosure mounting attachments shall be accessible for easy installation and replacement of the unit.
- (4) Whenever enclosures are supported by their mounting attachments, threaded studs and self-locking nuts shall be used to facilitate their installation.
- (5) All onboard equipment shall be housed in dust tight enclosures no less than IP54.
- (6) Heat generating equipment shall have suitable heat sinks located on external surfaces of the enclosures and be cooled by natural airflow.
 - (a) Cooling fans are not acceptable.

xii). OTIS Off-Board Customer Experience Simulation

- (1) A fully featured off-board customer experience simulation lab shall be provided to simulate all aspects of the journey. See Chapter 26 for specific requirements for the physical test lab specification.

xiii). OTIS Journey Logging

- (1) A comprehensive set of logs shall be captured on each car and be collected and organized per consist for each journey initiated by Amtrak crew or systems.
- (2) The log shall include the set of system inputs and triggers received by the on-board systems necessary to recreate system performance in the OTIS Off-Board Customer Experience Simulation lab for the purpose of troubleshooting a journey configuration, further content development, and other uses.
- (3) The log shall include a summary of system operations and outputs, including actions taken per display screen, audio announcements made per car and per audio zone, and general status of communication equipment.
- (4) The system shall be capable of maintaining journey logs for a minimum of 30 days.
- (5) Log offload shall be enabled through the DCS based on as-demand and/or on a scheduled basis as configured by Amtrak.

b). System Operation

- i). The OTIS system shall automatically identify all cars in the trainset by their car number and their location in the consist as soon as the train is formed, and power is applied.
- ii). The OTIS system shall determine the train location with the use of the GPS receiver, with fallback to tachometer received via the Ethernet Car Network.

- iii). The system shall self-report faults and errors in real-time over the air, and issues reporting and logging shall be automatic and feed into Amtrak systems. Additional diagnostic requirements can be found in Chapter 24.
- iv). System operation shall be a simple, clearly intuitive operation for the train crew.
 - (1) This shall include the commands necessary to initially establish the system operation at start of trip, making revisions during the trip (such as adding station stops, skipping station stops, special messages, food service advisory messages and so forth) and the conclusion of a trip.
 - (2) Such actions should be easily performed in a simple way without the need to refer to instruction lists.
 - (3) Any manual mode PA announcement by the train crew shall override any automatic announcement which may be taking place.
- v). The system shall be configured to easily allow the train crew to designate one or more cars as a "Quiet Car". This information shall be displayed on the car interior and exterior sign displays, and permit adjustment of audio announcements to a lowered level, as well as other features to be selected by Amtrak.
- vi). It shall be easily possible for the train crew to designate a car on a local car basis to be a deadhead car (out of service) and provide suitable interior and exterior sign messages.
- vii). Trip Operation
 - (1) To establish the initial operation of the system at the start of a trip, the system shall use the train number and provide a means to confirm origin and destination.
 - (2) The associated content database entry for that train number will automatically establish the destination sign displays and the automated station announcements.
 - (3) The system shall permit programming flexibility to not make some or all destination sign displays (which may differ from the exterior and interior sign displays) or not make some or all automatic announcements.
 - (4) Such conditions may be encountered on late evening/overnight trains or on an individual "Quiet Car". At end of trip, a means shall be provided to automatically clear all displays after a programmable display of the last arrival / standing message.
- viii). The system shall take into consideration the length of trip for Long Distance operations, and shall reliably operate across several days without manual or automatic reboots or train crew interaction.

14.5 OTIS Requirements

a). Display Signs

i). General Requirements

(1) Sign Performance Requirements

- (a) Signs shall be clearly readable in all ambient light conditions including total darkness and direct sunlight.
 - (b) The minimum viewing angle shall be 160° and readable at a distance of at least 115 ft for exterior and 45 ft for interior signs.
 - (c) The display shall have a high contrast ratio and have an automatic LED luminosity control for different levels of ambient light conditions.
- (2) LED dimming shall also be activated automatically by the OCU, to reduce low voltage supply consumption and extend backlight life, in case of car battery charging failure or during train layover.
 - (3) All signs shall resume normal operation following supply power interruptions. No abnormal sign behavior shall follow any supply power interruption and reapplication.
 - (4) The signs shall be housed in a dust-proof enclosure with a polycarbonate non-glare display faceplate with anti-graffiti resistant film applied, at each end of each car.
 - (5) Signs shall have a self-diagnostic testing capability and provide fault condition information to the OCU, including sign location and type of fault.
 - (6) OTIS shall monitor the uptime, availability, and performance of each individual sign, and provide reports and logs through onboard PTU and wayside interfaces.
 - (7) The sign unit, upon the insertion of the car wiring connectors, shall automatically recognize its own location in the car, through special coding in the car-side connector pins.

ii). Interior Display Requirements

- (1) Interior signs shall be sufficiently sized to maximize display area in the identified locations and be 4K displays with a resolution of 3840x2160 pixels. They shall be capable of:
 - (a) Audiovisual automatic announcements that include information such as present station, next station, route map, and arrival times.

- (b) Text displays that may include time and date, train number, destination, and on-time and delay information.
 - (c) Special messages received from the onboard personnel and/or triggered from the wayside.
 - (d) Animated graphic displays, including entertainment, advertising, and content driven by wayside feeds configured by Amtrak.
 - (e) Reservation information for specific areas of the train.
 - (f) Menu options in café areas.
 - (g) Other requirements as defined in this Chapter and in Chapter 26.
- (2) The displays shall utilize the maximum available space and maximize the sign display area, with minimal bezels or unused screen area.
 - (3) Displays shall include ambient light sensors and be configured for auto-dimming.
 - (4) The signs shall meet all applicable The Americans with Disabilities Act (ADA) regulations and requirements, and the ADA Accessibility Guidelines (ADAAG) for Transportation Vehicles, including Subpart F.
 - (5) The signs shall be mounted in a tamper-proof anti-theft enclosure with tamper-proof fasteners.
- iii). Interior Display Types
- (1) Vestibule Screens
 - (a) Two 16:9 aspect ratio portrait-oriented vestibule screens shall be located at each vestibule location, including on the lower-level entrances of the Bi-Level coaches, and upper-level vestibules.
 - (b) One vestibule screen on each car shall be paired with a PA/IC Controller and also function as a Control Terminal.
 - (2) Stairway
 - (a) A 16:9 aspect ratio portrait-oriented screen shall be located at the top of each staircase on Bi-Level coaches in order for Amtrak to provide wayfinding information for passengers.
 - (3) Ceiling-mounted wide aspect displays
 - (a) Two ceiling-mounted wide aspect ratio (16:3) signs shall be installed in each upper level where possible.
 - (4) Alternative displays in passenger compartment

- (a) Where ceiling mounted wide aspect ratio displays are not practical, the contractor shall propose alternative display types such that each seated passenger has the ability to view a high resolution graphical display screen from their seated position in all coach areas.
- (5) An interior graphical display shall be located at the entrance to the First Class Lounge area, for the purpose of identifying or designating lounge reservation status.
 - (i) The display shall be maximized for the interior panel configuration, and minimally be a 32" display.
 - (b) Three (3) interior graphical displays shall be located at each café area to display menu options and other information as configured by Amtrak.
- (6) An interior graphical display shall be located in each accessible bedroom, for the purpose of providing additional accessibility to passengers who would benefit from additional visual information in their passenger compartment.
 - (a) The display functionality shall be configurable through the Amtrak content management system.
 - (b) The display shall provide a variety of screens which provide visual information that includes active and past announcements, current time, current train location, location of the compartment in the train and consist, and train amenities.
 - (c) The announcements log shall include a timestamp that indicates when the announcement was made and shall have the ability to scroll through prior announcements based on an Amtrak configuration value, initially set to 30 minutes. Doorbell rings shall be annunciated visually in the log of messages, and strobe if the display is configured by the passenger to do so.
 - (d) In addition to standard announcements, Amtrak shall be capable of programming the display and announcements in the accessible bedrooms with additional notice to provide passengers with special needs additional time to prepare for arrival.
 - (i) The announcements shall be configured to provide additional details about the car, the evacuation plan, orientation of the compartment in the car and in the train, details of the t-coil system provided in the car.
 - (ii) Other information, configurable by Amtrak via content loads, about what is to be expected during the trip.

- (e) The interior graphical display and compartment announcements shall be configurable based on the passenger's trip information, as configured by the reservation display system, such that the advanced arrival indication and announcements occur based on their planned trip.
 - (f) The display shall be configurable via the compartments Passenger Compartment Control Unit, including:
 - (i) Enabling or disabling a "strobe" mode which flashes the screen in advance of the visual indication of the ongoing announcement.
 - (ii) Enabling or disabling the read-back of public announcements.
 - (iii) Turning off the screen; and configuring the screen to turn off other than for announcements or configuring it to be always off.
 - (iv) Playback of emergency information video
- iv). Exterior Display Requirements
- (1) Exterior display sign shall be provided on each side of each vehicle to provide clear indication to passengers boarding relevant information about the train, car type, and amenities of the car.
 - (2) Exterior display signs shall have a 16:9 aspect ratio and be oriented in a landscape fashion, with a diagonal screen size of 40".
 - (3) Exterior sign messages shall be configurable, and be capable of displaying train number, car number, car type, service type, destination, and other messages as programmed by Amtrak with fixed, paged, and scrolling text.
 - (4) The exterior signs shall be full-color LED matrix (red/green/blue), high resolution and high brightness (1,300 nits minimum), with full multi-colored text and graphical capabilities.
 - (5) Final selection of exterior sign capabilities, including pixel dot pitch, shall be reviewed and approved during Design Review.
 - (6) All LED modules shall be controlled to extend LED life for a service life of no less than 12 years.
 - (7) The signs shall be installed and supported to prevent any rattling, dust infiltration or movement of the sign itself.
 - (8) The sign support shall allow for sign tilting to allow cleaning of the glass behind the sign.

- (9) Exterior sign glazing must meet FRA type 2 projectile resistance, unless installed on the outside of the carshell.
 - (10) The exterior signs shall be designed to prevent fog and condensation and shall be resistant to any dust ingress or short periods of immersion in water.
 - (11) In addition to exterior full-color LED matrix graphical display signs, Amtrak is interested in supplier proposals for advanced display technologies including the use of exterior projection mapping for boarding location indication on station platforms.
- b). OTIS Control Unit
- i). The OTIS Control Unit (OCU) shall control all interior and exterior signs on that car for visual messages and provide digital input to the PA amplifier for audio announcements.
 - ii). The OCU shall monitor the signs and PA status for fault diagnostics and shall digitally communicate with all other OCUs in a trainset over the DTL to verify their car systems status.
 - iii). The OCU shall be a microprocessor-controlled device, have an open architecture and allow expansion for communication and interface with additional other systems including the car's central diagnostic unit.
 - iv). In addition to the ports required for this expandability, at least one spare port shall be provided on each switch.
 - v). The OCU microprocessor usage shall not be greater than 60% of the available processor capacity.
 - vi). The Contractor shall provide all the software needed to operate the OCU. Message capability shall include, but not be limited to the following:
 - (1) Standard station stops
 - (2) Advertising messages, including audit logs of advertising playback
 - (3) Public service messages
 - (4) Unique messages, including trainset specific messaging and car number messaging (for ticketing).
 - (5) Emergency messages
 - vii). The OCU-stored data shall be divided in several files, following their specific function, and stored in non-volatile memory.
 - (1) Modifications to the OCU-stored data shall be achieved by changes only to the parts affected, to minimize the transmission time.
 - viii). Back-up batteries shall not be used.

- ix). Where removal of the chip is required for reprogramming, memory chips shall be socketed to make it easy to upgrade and replace.
- x). The OCU microprocessor control shall re-initialize automatically and safely at power up, and/or following loss of supply power.
- xi). All OCU inputs and outputs shall be galvanically isolated from the external circuits. Shorting or opening of any of the inputs or outputs shall not result in any damage to the internal circuitry of the OCU.
- xii). The OCU shall have a specific port for connection to a PTU.
- xiii). All fault, diagnostic, status, and log information on the OCU shall be made available to the car's central diagnostic unit for remote access.
- xiv). All OCUs shall be directly interchangeable and capable of performing the same functions without the need for re-programming or re-configuration.
- xv). All data communication between the train's OCUs shall be through the ETB.
- xvi). The OCU shall also contain a bi-directional analog interface module that utilizes the 27-pin COMM trainline as a fallback or when interfacing with legacy equipment.
- xvii). The OCU should output per APTA PR-E-RP-017-99 maintaining compatibility with legacy equipment.
- xviii). The OCU should also be able to receive signals from legacy cars and locomotives via the 27-pin COMM and convert them for transmission along the DTL to the remaining OCUs in the trainset.
- xix). The OCU shall have a self-diagnostic capability and store faults occurring in the OCU and in the other controlled systems, such as the signs and the PA amplifier.
- xx). The OCU shall have on a clearly visible location, separate from the display, a multicolor LED indicator providing indication of the car OTIS/PIS status.

Table 14-1 OTIS/PIS status Indicator

LED indicator	OTIS / PIS status
Green	Normal
Yellow	Fault
Red	Failure

- (1) The yellow indication shows that the system is working at a diminished performance, and that investigation, reset or repair is required, but the train may remain in service.

- c). OCU Diagnostic Capabilities
 - i). Faults shall be recorded with reference data including:
 - (1) car number
 - (2) time
 - (3) date
 - (4) location
 - (5) consist arrangement
 - (6) train number
 - (7) Other reference data defined by Amtrak at design review.
 - ii). The fault memory shall store at least 100,000 faults in a first-in, first-out sequence.
 - iii). The self-diagnostic system in the OTIS shall be capable of identifying the faulty component down to the replaceable unit and indicate the electronic module which requires replacement.
 - iv). All subsystem signals, including all system hardware inputs and outputs (whether they are used or not), and software variables that impact the functionality of the system shall be transmitted to the CDU for viewing and recording in data monitoring systems.
 - v). This information shall be stored in non-volatile memory locally and be transmitted for recording within the fault log in the CDU.
 - vi). The diagnostic capabilities, including the list of signals, list of faults, and demonstration
- d). Passenger Compartment Control Unit
 - i). Each sleeper compartment shall be comprised of a touchscreen-based digital display Passenger Compartment Control Unit.
 - ii). The Passenger Compartment Control Unit shall enable control of the following items:
 - (1) Control of passenger compartment lighting, shades, including dimming, color selection, and accent lighting adjustments
 - (2) Control of passenger compartment cabin temperature settings
 - (3) Control of passenger compartment speakers, including:
 - (a) Selection of live public address audio channel(s)

- (b) Selection of automatic announcements, or only automatic announcements relevant to the passenger's trip, as configured based on the reservation display system data.
 - (c) Selection of audio playlists / tracks pre-programmed by Amtrak
 - (d) Volume control of compartment speakers, including muting
 - (4) Control of indication on the Reservation Display System (including make-up room, do not disturb)
 - (5) Control of Attendant Call requests, including two-way high-fidelity audio
 - (6) Muting of room doorbell functions
 - (7) In accessible bedrooms, control of the additional accessibility screen including display blanking, display mode, enable high contrast mode, and other accessibility features shall be provided.
 - (8) Other functions as defined by Amtrak during design review.
 - iii). For accessibility, the passenger compartment control unit shall implement a method of voice control for all functions.
 - iv). The Control Unit shall be template based and allow Amtrak to update and adjust functionality on a per-compartment basis. This includes:
 - (1) implementation of route displays,
 - (2) customized welcome messages based on passenger,
 - (3) PA messaging,
 - (4) availability of train amenities including dining rooms and view cars, and
 - (5) wayfinding information
 - v). Pre-loading of control unit settings shall be possible through integration with Amtrak enterprise systems, such that Amtrak may update passenger compartment settings based on individual passenger preferences.
- e). Sleeper Compartment Hospitality TV Provisions
- i). Each sleeper compartment with a queen-sized bed shall include provisions for Amtrak installation of a passenger compartment hospitality-grade TV.
 - ii). The provisions shall support screen sizes of up to 43" and be designed for televisions which weigh up to 50 pounds.
 - iii). The provisions shall include television mount, 120VAC power, and a CAT-6A Ethernet cable that provides access to one of the Passenger Wi-Fi switches defined in Section 14.6b).

- iv). An HDMI extension shall be provided from the TV mounting location to a location convenient for connecting a passenger supplied device.
 - (1) The HDMI port shall be adjacent to the passenger accessible 120VAC power outlet and USB-C and USB-A power point.
- v). The design and installation of the television and television mount shall take into consideration the likelihood of technology replacements throughout the life of the compartment, and shall provide for adjustment.
- vi). The Contractor shall demonstrate the designed provisions support the installation of 40-43 inch class displays with models from at least three manufacturers.
- vii). The Contractor shall submit the detailed design of the Hospitality TV Provisions for Amtrak review and approval **[CDRL 14-04]**
- f). Reservation Display System
 - i). A comprehensive reservation display system shall be provided that is controlled by the OTIS
 - ii). The system shall be capable of displaying Amtrak configured reservation information at each passenger position on the train, including:
 - (1) Coach and Premium Coach Seats
 - (2) Mobility Positions
 - (3) All sleeping class locations (Rooms, roomettes, and nest rooms)
 - iii). The system shall be capable of displaying both availability of seats as well as reservation information in a clear to read, high-resolution, TFT LCD based displays.
 - (1) Reservation displays shall be configurable on a per-location, per-car, and per-train basis based on pre-loaded templates that are configurable by Amtrak.
 - (2) Displays shall be full-color graphical displays.
 - (3) The displays shall be capable of displaying a line of text, minimum 30 characters long, for each passenger position in the train. Displays shall support smooth scrolling for messages that exceed the maximum text line size.
 - (4) Display size, capabilities, and resolution shall be based upon the location in which they are used, including the distance from the position of a passenger standing in the car aisle adjacent to the display. Displays shall be a minimum of 480x224 pixels of resolution, with a display area of 275x75x25mm.

- (5) Display dimming shall be coordinated with interior passenger information signs and interior lighting status.
- iv). Discrete RGB LED indicators shall be provided to indicate status for each reserved location. The indicator shall be capable of being configurable by Amtrak to display a variety of colors based on the exposed Seat reservation API, and shall be initially configured to show:
 - (1) reservation status, including:
 - (a) Reserved (red)
 - (b) Open (green)
 - (c) reserved at a further point in the trip (yellow)
 - (2) ticket lift status (orange, until a lift has been performed by an Amtrak conductor, or the customer has checked-in, in which case it will show reservation status)
- v). The system shall be capable of receiving near-real-time updates on a seat-by-seat basis at all points of a trip via secure API from ground.
- vi). The reservation display system screen installation shall be reconfigurable to match seat pitch and location and shall be approved during Design Review.
- vii). Reservation displays shall be supplied at all seats and areas which may be reserved by passengers, such as handicap accessible locations and bike storage areas.
- viii). In conjunction with controls in sleeper-class rooms, the reservation display system shall incorporate the display of passenger requests, including:
 - (1) Do Not Disturb
 - (2) Make Up Room
 - (3) Attendant Call
- ix). Each sleeper class rooms reservation display, or approved alternative, shall incorporate a doorbell button which shall ring inside the audio zone of that compartment. The door bell shall be mutable through configuration on the Passenger Compartment Control Unit.
- x). In addition to the use of discrete reservation displays, Amtrak is open to supplier proposals which use alternative technologies, such as transversely mounted ultra-stretched TFT LCD displays at the ceiling to wall transitions, to functionally replace several reservation displays with one device.

- g). Electronic Room Accommodation Door Lock System
 - i). Each sleeper compartment, including rooms, roomettes, and nest accommodations shall include an electronic room accommodation door lock with a high security manual keyed override.
 - ii). The electronic accommodation door lock shall be an online system providing live tracking of cards and users, be reported to the OCU, available on the Control Terminal, and on the wayside via the Data Communication System.
 - iii). Door Lock Requirements
 - (1) The door lock and handle shall be ADA compliant.
 - (2) Each lock shall implement the following access technologies for room access:
 - (a) RFID
 - (b) NFC
 - (c) Bluetooth Low Energy (BLE)
 - (3) RFID access shall be implemented through NXP MIFARE Plus® or alternative approved by Amtrak
 - (4) Each RFID reader shall be of modern, minimalistic design that blends with the interior design of the railcar interior.
 - (5) The door lock shall implement a panic release function.
 - (6) The door lock shall be PoE-powered and include back-up batteries to maintain power in the event of a loss of power or network failure.
 - (a) Batteries shall have a minimum estimated life of 2 years.
 - (b) Low battery status indication shall be reported to the OCU, available on the Control Terminal, and provided to the wayside via the DCS.
 - (7) The door lock shall provide a lighted status indicating card reader status, including:
 - (a) Access-granted
 - (b) Invalid card
 - (c) Low battery
 - (8) The electronic door lock shall incorporate manual override through a physical key, including keys configured as master keys.

- iv). The door lock system shall provide capability to integrate mobile keying into Amtrak developed mobile applications and back-end systems.
 - (1) The mobile keying shall support Apple and Android handsets.
 - (2) Digital wallets shall be supported, including Room Key in Apple Wallet
- v). Access to the rooms shall be configurable for access as directed by the Amtrak reservation systems, with input from Amtrak Control Terminals and through the Amtrak Crew Applications.
 - (1) Door Lock access rules shall be configurable by Amtrak
 - (2) Access rules shall integrate with the OTIS system, such that door access may be configured:
 - (a) to trigger or expire when arriving and/or departing at a station stop
 - (b) at particular locations
 - (c) based on time and date rules.
 - (3) Special credential types shall be integrated into the access rules, including:
 - (a) passenger keys
 - (b) master keys
 - (c) emergency keys
 - (d) specific coach keys
 - (e) maintenance keys
 - (f) time-based keys.
- vi). Key encoders shall be provided adjacent to at least one OTIS Control Terminal on each car with sleeper compartments, in the crew lounge, and at each conductor office.
- vii). Authorized users of the Control Terminal shall have the capability to enable a central override of all and/or selected door locks.
- viii). The keying system design, arrangement, and security consideration for the manual override key shall be submitted for review and approval by Amtrak.
[CDRL 14-05]
- ix). The design and integration of the Electronic Room Accommodation Door Lock System shall take into consideration that Amtrak will routinely couple, uncouple, and rearrange consists.

- (1) The system shall reorganize based on actual train configuration, such that the appropriate set of rooms and locks are displayed on Control Terminals, through interface with Amtrak Crew Applications, and through the DCS.
- h). Video Surveillance System
- i). Amtrak currently utilizes Genetec for surveillance video management throughout its enterprise, and the Contractor shall be responsible for supporting the integration of the onboard video surveillance system shall with the existing wayside systems in use at Amtrak.
 - ii). Data storage and system functionality shall be separate from any cab video systems unless approved by Amtrak.
 - iii). The integration with the Enterprise VSS shall include:
 - (1) System shall allow wayside users to view and manage the onboard video from the enterprise VSS platform
 - (2) Video shall be remotely accessible using the Data Communication System (DCS)
 - (3) System should support automated connection to a Wi-Fi network, 4G/5G cellular (when Wi-Fi is not available) and automated off-boarding of video to a ground-side repository.
 - (4) System shall have access to live videos from a dedicated camera stream configured for remote viewing
 - iv). The Contractor shall supply a Genetec based onboard digital video surveillance system.
 - v). The video surveillance system shall monitor and record data acquired from multiple onboard camera sources that shall be arranged to maximize the coverage of the vehicle and its operations.
 - vi). Each onboard camera shall include the following capabilities:
 - (1) have day and night capabilities with performance down to at least 0.1 lux
 - (2) provide high quality color video.
 - (3) Cameras shall comply with EN50155, EN45545, and NFPA130
 - (4) Camera housing shall meet IP66, IP67, and IK10 ratings
 - (5) Cameras shall have electronic image stabilization built-in
 - (6) Cameras shall include invisible IR LED built-in
 - (7) The cameras shall have adjustable resolution of at least 1080p

- (8) The Camera connector shall comply with 14.8e)
 - (9) Frame rates adjustable up to thirty (30) frames per second
 - (10) The cameras shall natively support encoding in H.264 and H.265 video compression
 - (11) Model AXIS P3935-LR M12 Network Camera preferred
- vii). VSS Power Requirements
- (1) The system shall operate continuously off the low voltage power supply system and be backed up by car battery as a vital load.
 - (2) Prior to the loss of low-voltage power (e.g., due to load shed or train shutdown), the Genetec NVR shall be configured to safely shut down.
 - (a) This may be implemented using a dedicated uninterruptable power supply for the NVR, or
 - (b) through software means such that sufficient time is provided to the NVR to safely shutdown the system prior to load shed or vehicle shutdown from being triggered by a vehicle.
- viii). Camera Locations
- (1) A minimum of four (4) interior cameras shall be placed throughout each car to facilitate recognition of passengers and/or luggage onboard *the* rail vehicle.
 - (2) One camera shall be mounted in each lower-level vestibule with 360-degree coverage of the vestibule, lifts, stairways, and side doorways.
 - (3) No less than two cameras shall be mounted in each passenger seating area of each car.
 - (a) Cameras mounted in the passenger seating area shall be facing in opposing directions with overlapping viewing zones to maximize coverage.
 - (4) No less than two cameras shall be mounted in each baggage area of each utility car.
 - (a) Cameras mounted in the passenger seating area shall be facing in opposing directions with overlapping viewing zones to maximize coverage.
 - (5) Cameras shall be mounted to provide coverage of hallways, stairways, and lifts of all cars.
 - (6) Each food service vending location, including bars, cafes, and shops, shall be covered by a minimum of two (2) cameras.

- (7) Camera installation and arrangement shall support identification based on the IEC EN62676-4:2015 International Standard of a minimum of 250 PPM (pixels per meter) or higher to identify individuals.
- (8) The Contractor shall be responsible for submitting a coverage plan identifying the location, viewing angle, and details of the camera arrangement and capabilities to Amtrak for approval. **[CDRL 14-06]**
- ix). Each camera shall deliver compressed video in real time to the Genetec based NVR. All video cameras provided shall have a proven history of reliable operation on rail vehicles.
- x). The surveillance system shall commence recording data when the car is powered on, and continue recording until the car is powered off, unless otherwise directed by the Engineer.
- xi). NVR Requirements
 - (1) The NVR shall be configured with sufficient solid state storage to capture a minimum of 90 days of full car video storage high-quality onboard transportation scenes at 1920x1080p resolution at a minimum of 15 fps continuous recording in each car before overwriting.
 - (2) The NVR shall be capable of incorporating telemetry data and other metadata received from onboard systems including CDU, the subsystems that report to the CDU, as well as the OTIS.
 - (3) Metadata recorded by the NVR, to be made available when viewing, searching, and downloading video shall include:
 - (a) Synchronized date and time as other network components
 - (b) Global Position System (GPS) Location
 - (c) Consist speed
 - (d) Route information, including current trip, train number, most recent station location, next station location, location along the alignment
 - (e) Local car number for each camera stream
 - (f) Consist layout
 - (g) Card access audit events provided by the Electronic Room Accommodation Door Lock System
 - (h) Signals required for the triggers identified in the following section
 - (4) Functionality shall exist to tag and persist segments of video beyond the 90 day limit based on specific train events or triggers.

- (5) Tagged segments shall be capable of recording no less than 5 minutes prior to and 10 minutes following the trigger or event and be configured to apply to cameras relevant to the triggered event.
 - (6) Triggers shall include, but not be limited to:
 - (a) Passenger Emergency Intercom request
 - (b) Door Emergency Egress / Ingress
 - (c) Door obstruction detection
 - (d) Emergency brake event (above zero speed)
 - (e) Penalty brake event (above zero speed)
 - (f) Fire suppression system activation (if equipped)
 - (g) Ride quality monitoring alert
 - (7) Using on-board intelligence, the system shall be capable of selectively off-boarding only the video content that is determined to be relevant, and not ambient video, to the Enterprise VSS Platform.
 - (a) Through this method, it shall be possible to limit the off-loading of video to prevent trainset interior from an overnight in a yard with no passengers or staff onboard.
 - (8) The system shall automatically overwrite non-tagged video after 90 days has elapsed.
 - (9) In the instance of the failure of a single NVR, a mechanism shall be implemented to facilitate the failover of cameras video archiving to an alternative NVR, such that failure of any single component of the Video Surveillance System does not impair all video recording on a car.
- xii). Chain of Custody Requirements
- (1) The surveillance system shall utilize methods and system controls to ensure chain of custody of all collected video and associated data from camera to ground.
 - (2) All acquired data shall be written, stored, and encrypted.
 - (3) All data shall reside on the rail vehicle on one or more solid state drives (SSD) that are designed and applied for the purpose of mobile data acquisition and storage.
 - (4) All storage shall be locked via a secure key to prevent access yet shall be easily removeable and replaceable to facilitate use as evidence.
 - (5) Data from the video surveillance system shall be available for real-time access for authorized personnel.

- (6) An audit trail of personnel accessing the data shall be maintained on both the on-train VMS and within the wayside software (including video download, live view, and configuration).
- xiii). Recording failures or system failures shall result in an alert available through the Control Terminal, CDU, and to Amtrak's Enterprise VSS Platform (Genetec Security Center Platform).
- xiv). All components supplied as a part of this contract, including Video Surveillance System cameras and NVRs, shall be compliant with the requirements of the National Defense Authorization Act.
- xv). No equipment or services found on the Covered List as maintained by the FCC's Public Safety and Homeland Security Bureau as outlined in Section 1.50002 of the FCC's rules, and as directed by the Secure Networks Act, shall be supplied as a part of this contract.
- xvi). The Contractor shall submit a comprehensive architecture and design package for review and approval. **[CDRL 14-07]**
 - (1) This submission shall include proposed camera layout, proposed calculation of retention, NVR software features and capabilities, redundancy capabilities, and details of integration between the on-board VSS and Amtrak's wayside Genetec installation.
- i). Control Terminal
 - i). Each car shall be equipped with control terminals adjacent to each of the PA/IC control stations.
 - ii). Control Terminals shall be implemented as a high-resolution touchscreen display, and be multi-purpose devices that meet the requirements of the passenger graphical displays.
 - iii). The Control Terminal shall be a high-resolution touchscreen display
 - (1) Screen size shall be a minimum of 15" in crew rest areas and conductor's office and
 - (2) At passenger boarding areas, the screen size, orientation, and look shall match the vestibule displays and be a minimum of 30" with 16:9 aspect ratio. When not in use by Amtrak crew, the display shall revert to a graphical information display.
 - iv). In cars with a conductor's office, the control terminal shall be located in that office.
 - v). The control terminal shall be the main HMI for between the operator and the car functions, including providing access to the diagnostic information contained on the CDU, as well as control of the OCU and communication system functionality of the train.
 - vi). The Control Terminal shall implement the following functions:

- (1) Allow train crew to input train number to configure the OTIS systems
 - (2) Initiate system and route start-up
 - (3) Trigger pre-programmed message selection and initiation
 - (4) Record and triggering of custom public address announcements that include a text component through an onscreen keyboard and editable speech-to-text and text-to-speech mechanisms.
 - (5) Control and adjustment of the reservation display system
 - (a) Modification of seat and room assignments / booking status
 - (6) Control of the electronic room accommodation key system for the entire train
 - (a) Issuing and encoding new RFID and mobile keys for a particular room and reservation
 - (b) Revoking issued RFID and mobile keys
 - (c) Verifying issued RFID and mobile keys
 - (d) Configuring room access, marking rooms as ready post-servicing
 - (e) Reviewing system audit trail including credential issues, uses, and system operations
 - (7) live and recorded video surveillance review
 - (8) train formation display
 - (9) local display for fault annunciation
 - (10) Initiate system tests and verification
- vii). The control terminal shall:
- (1) Be of rugged heavy-duty construction
 - (2) Include a projected capacitive touchscreen
 - (3) Provide a high-resolution visual display, 1920x1080 minimum.
 - (4) The front panel shall have no exposed fasteners.
 - (5) The display shall be readable in both direct sunlight and total darkness
 - (6) The display shall include auto-dimming features.
 - (7) The display shall be LCD with LED backlight and adjustable contrast and backlight intensity.

- (8) Have a front-bezel rated to IP65
- viii). Control terminals shall implement a screen locking functionality utilizing personal identification and pin code. Access to enter ID and pin information shall be obscured, and pin and ID entry position shall move with each use. ID and pin validity shall be maintainable by routine updates by Amtrak through integrations with wayside systems.
- ix). When the display is electronically locked, the display shall act as an additional OTIS graphical display and be capable of being configured by Amtrak to display electronic messages, route information as per the requirements of 14.4a).
 - (1) Displays located in the crew rest areas shall be configured to turn off the display upon activation of the electronic lock.
- x). The control terminal shall be menu-driven for all the functions and the key legends shall correspond to the functions being performed.
- xi). Data storage, if included in the control terminal, shall be via non-volatile solid-state memory.
- xii). OTIS System Test Capability
 - (1) Through each control terminal, and through the PTU, a system self-test shall be possible to facilitate quick one-person confirmation of system functionality of all OTIS components throughout a coupled consist.
 - (2) The self-test shall include options for train crew to perform:
 - (a) Automated verification that each PEI works, including microphone and speaker transmission.
 - (b) Automated verification that individual PA Amplifiers and the speakers zones the power are functional.
 - (c) Automated verification that each hearing loop has continuity, and that current is flowing when audio is sent to the hearing loop amplifier.
 - (d) Automated verification that all displays, including graphical displays, accessibility displays, exterior displays, and seat reservation displays are connected and addressable.
 - (e) Automated verification that all electronic locks are online and responsive.
 - (f) Automated verification that all control units are addressable and functioning, including Control Terminals and Passenger Compartment Control Units.

- (g) Automated verification that the NVR is communicating, and that all storage and cameras are operating.
 - (h) Guided verification of other system elements, such as display screens via a test pattern, physical buttons through a circle-check, and cameras via on-screen display.
 - (3) At the conclusion of the self-test, a report shall be recorded and displayed on screen that indicates the systems tested and the results of the test.
 - (4) Results shall be available to Amtrak Enterprise Systems via the Data Communication System
 - (5) The contractor shall submit documentation defining the capabilities of the self-test functions for approval **[CDRL 14-08]**
 -)). Data Communication System (DCS)
 - i). The Data Communication System (DCS) shall incorporate all the data transmission radios necessary to support the train to wayside communication as a part of the onboard systems, including communication required as a part of any system requiring offboard communication, including the OTIS / PIS / communications systems, the video surveillance system, the diagnostic systems, and bogie/carbody monitoring systems.
 - ii). To minimize the use of disparate communication systems requiring additional roof space, systems requiring dedicated wireless access outside the use of an integrated Data Communication System shall be submitted to Amtrak for review and approval.
 - iii). The DCS shall allow for data transmission between the onboard systems and wayside software provided by the Contractor, as well as support Amtrak's requirements as it relates to existing and future Amtrak system servers.
 - iv). The DCS shall automatically utilize and aggregate all available communication links throughout the train so that the highest data transfer capability is available for any train location.
 - v). DCS Antennas
 - (1) Antennas used for the DCS shall meet the requirements of Amtrak Specification 963.
 - (2) Each antenna shall support 4x4 cellular MIMO supporting frequencies from 600Mhz to 4200MHz (US cellular operator bands) and GPS/GNSS, and 2x2 Wi-Fi 6e frequencies from 2400 to 2495 MHz and 5170 to 7125MHz.
 - (3) Two antennas shall be provided on each car for use by that cars DCS router.

- (4) To support future active rooftop equipment as a DCS link, an Ethernet capable that meets the requirements of 14.6 c) shall be installed between an ECN Switch with a spare PoE port and the location of each DCS Antenna.
- vi). DCS Router
- (1) A DCS router shall be installed on each car to provide access to cellular and Wi-Fi infrastructure.
 - (2) Each DCS router shall provide two DCS modems to support redundant connections to major carrier networks, providing 4x4 cellular MIMO performance for each modem utilizing the DCS Antennas.
 - (3) The DCS modems shall be 5G capable with automatic fallback to Cat-20 4G LTE.
 - (4) The device shall be approved for use on all major carrier networks including Verizon, AT&T, and T-Mobile.
 - (5) Shall be connected to the Ethernet Car Network via a 1 Gbps or greater connection.
- vii). In conjunction with wayside software, the Data Communication System shall facilitate aggregation of all available DCS Router channels throughout the consist to maximize the available bandwidth to onboard applications, and to provide resiliency and redundancy in the event of any carrier, modem, router, or antenna failure, or in instances of limited signal coverage.
- viii). The Data Communication System, in conjunction with on-board subsystems and wayside software supplied by the Contractor, shall provide:
- (1) Transfer of consist monitoring and diagnostic data from the train to the wayside
 - (2) Transfer of train status information from the train to the wayside
 - (3) Remote troubleshooting of car systems
 - (4) Transfer of content database updates from the wayside to the train, including:
 - (a) Content
 - (b) Schedule
 - (c) Informational Messages
 - (d) Editorial content
 - (e) Dynamic content (e.g., based on feeds)

- (5) Transfer of software updates from the wayside to the train (for controlled installation on the train)
 - (6) Transfer of wayside initiated manual announcements (audio, text, graphical, and video) messages from the wayside to the train
 - (7) Transfer the trigger of train wide pre-defined public and special message to the communication system
 - (8) Transfer of recorded or real time video from the video surveillance system as configured by Amtrak's Enterprise VSS Platform.
 - (9) Transfer of logs from the graphical displays, audio playback, and other OTIS performance indications
- ix). The DCS system components, including the 4G/5G and WiFi modem and antenna shall be designed in such a way to facilitate future upgrades which will occur throughout the life of the vehicle.
- x). The Contractor shall provide a document to Amtrak identifying the standard interface which would allow the integration of a replacement or additional DCS communications channels **[CDRL 14-09]**
- k). Global Positioning System (GPS)
- i). The OTIS shall utilize a Global Positioning System (GPS) for the determination of the train location and the triggering of automatic station announcements and station display.
 - ii). The GPS receiver shall be a stand-alone unit or integrated into the DCS, powered by a dedicated power supply on each car and shall be capable of accuracy within 16ft.
 - iii). The OCU shall use the GPS for all location events. It shall not use wayside transponders or wheel rotation to determine the traveled distance when GPS is available.
 - iv). Door open signals shall be capable of triggering specified announcements as configured by Amtrak.
 - v). Whenever loss of GPS signal is experienced, the OCU shall maintain position via dead reckoning, and automatically re-establish train location once the GPS signal is again available.
 - vi). When the OCU loses GPS, all sign functions shall continue to be displayed. All OCUs shall be equipped with GPS.
 - vii). The antennas used for the DCS shall meet the requirements of Amtrak Specification 963.

14.6 Provision for Wireless Internet

a). General

- i). The Contractor shall procure and install the infrastructure required to support a wireless network with a 10Gbps (per channel) Ethernet backbone.
- ii). The scope of the requirements for this solution includes exterior and interior wireless and Wi-Fi antennas, exterior cellular antenna cabling, interior antenna cabling, data cabling, power cabling, a dedicated redundant Digital Train Line (DTL), and defined locations for equipment installation.
- iii). This Wireless Internet infrastructure is based on modular design for rapid component installation and simplified maintenance and serviceability. The design of the Provision for Wireless Internet shall be submitted for Amtrak review and approval throughout the design review. **[CDRL 14-10]**
- iv). As an option, the Contractor shall provide a solution for an on-board passenger Wi-Fi system for the trainset entirely that will provide passengers with secure, reliable and high-speed internet connectivity throughout all locations on the Amtrak long distance network.
 - (1) The Contractor shall supply an architecture with multiple access points distributed throughout the trainset with a high-speed internet connection via dedicated cellular network or satellite link.
 - (2) Hardware requirements shall be submitted to Amtrak for review and approval.
 - (3) Wi-Fi modems shall be at a minimum, Wi-Fi 6 (802.11ax).
 - (4) Cellular modems shall be at a minimum, 5G.
 - (5) The contractor shall provide a connectivity coverage map within each car type for Amtrak review and approval.

b). Wireless Internet Components

- i). MAR and AP Hardware Provisions
 - (1) All cars will supply a wireless Internet feed to the consist, distributed from the Mobile Access Router (MAR) over a DTL dedicated for passenger wireless internet to the rest of the consist.
 - (2) Additionally, all cars will provide Wi-Fi access to passengers and crew inside the car using multiple Access Points.
 - (3) All cars will include MAR hardware, AP hardware, and associated components. MAR and AP Hardware Provisions
 - (4) All cars shall include provisions and support for the following components:

- (a) Two (2) MAR mounting locations (device names are MAR 1 and MAR 2)
 - (b) Two (2) Access Point (AP) mounting locations (AP names are AP1 and AP2)
 - (c) Two (2) Switch mounting locations (Switch names are SWITCH1 and SWITCH2)
 - (d) Ten (10) 4x4 multiple-input multiple-output (MIMO) exterior antennas; two (2) antennas of the 10 also support GPS and Wi-Fi capabilities. (Antenna names are ANT1, ANT2, ANT3...ANT6. Port names are P1, P2, P3, P4, WIFI 1, WIFI 2, and GPS)
 - (e) Four (4) 6x6 MIMO interior ceiling antennas. (Antenna names are PLAN1, PLAN2, PLAN3, and PLAN 4. Port names are P1, P2, P3, P6.)
 - (f) Four (4) DTL bulk-head locations (two (2) on each end) (DTL connector name is DTLA1 or DTLA2 and DTLB1 or DTLB2 for A-end and B-end, left and right respectively. Port names are P1 and P4 for each DTL location. Each DTL umbilical shall house two (2) 10Gbps ethernet cables within their housing specifically for the Wireless Internet solution.
 - (g) Ethernet, RF, and power cabling to support the equipment.
- ii). Train to Ground / Satellite Provisions
- (1) In addition to the hardware found in all cars, utility cars, and coach end cars, shall include additional hardware to facilitate connection with a future Train-to-Ground (T2G) or Satellite connection.
 - (a) These cars shall include the following in addition to the requirements for MAR and AP Hardware:
 - (i) One (1) Train-to-Ground (T2G) Radio mounting location (T2G Radio name is T2G)
 - (ii) One (1) Satellite radio mounting location (Satellite radio name is SAT)
- c). Ethernet Cabling Requirements
- i). Cable and Connector Design Requirements
 - (1) CAT-7 rail-approved Ethernet copper cabling supporting 10Gbps throughput shall be utilized for all Ethernet cabling required to support the Provisions for Wireless Internet.
 - (2) All CAT-7 cabling shall be terminated with 8-pin M12 X-coded Male connectors.

- (3) The Contractor shall submit the cable and connector selection as well as the location of all cable terminations for approval by Amtrak.
 - (4) Cabling shall conform to the requirements of Chapter 19.
 - (5) Cabling and equipment installation shall conform to EN50155:2017 rail standards.
 - (6) The DTL shall connect the consist, and this cabling shall support a fault-tolerant ring network.
- ii). Cable Test Requirements
- (1) After installation on each car, each Ethernet channel shall be certified to ISO/IEC 11801-1 - Class F for each copper cable.
 - (2) Test results shall confirm channel suitability for IEEE 802.3an-2006 10GBASE-T for each copper channel.
 - (3) The Contractor shall submit the test procedure to Amtrak for review and approval.
 - (4) The certification results for each cable shall be submitted to Amtrak as part of the vehicle history book.
- iii). Cable Labeling Requirements
- (1) All Ethernet cabling shall be labeled clearly on both ends of the wire, observable with less than 90° of cable rotation. The Wireless Internet naming convention for Ethernet and Fiber leads is:
 - (a) Prefix = Contractor cable number (as the Contractor convention requires)
 - (b) Underscore = use the '_' character between the prefix and origin
 - (c) Origin = <SWITCH1 or SWITCH2> (port name not required)
 - (d) Destination = <-device name> with <-port name;' when applicable> (see 12.6.1 for component and related port names)
 - (2) For example, the label on the Ethernet cable which terminates at one end to Switch #1 and the other to MAR#1 reads as:

Xxxx-xxxx_SWITCH1-MAR1
 - (3) An Ethernet cable coming from Switch #2 does not require a port name on the label at the origin or destination; this example label terminates at AP#1 and is marked:

Xxxx-xxxx_SWITCH2-AP1

- (4) An Ethernet or fiber cable coming from Switch #2 does not require a port name on the label at the origin; this example label terminates at left-side DTL on the A-end at the Ethernet cable on port 4 it is marked:

Xxxxx-xxxx_SWITCH2-DTLA1-P4

d). Exterior Antennas and Cabling

i). RF Exterior Antenna Design Requirements

- (1) The Contractor shall establish eight (8) flat (0° relative to the roofline angle) antenna mounting locations atop the trainset on each car, with line-of-sight to both sides of the vehicle.
- (2) The antenna elevation, not the roofline must be the catenary/structure envelope limit, not the roofline of the vehicles.
- (3) Where Wi-Fi mobile Access Routers or train-to-ground, wayside, or satellite transceivers are to be installed, Amtrak requires a modular antenna mounting design using an interface plate in-between the train and the antenna allowing Amtrak to deploy or change antennas for the solution in all areas where antennas are used.
- (4) Each interface plate shall support 10 kg (22 Lbs.), except for satellite antenna locations where the mounting plate shall support up to 25 kg (55 Lbs.). With antennas spaced no less than 600mm (24") apart, the antenna locations shall support an antenna of:
 - (a) Cellular and T2G/Wayside Antennas - 465mm L x 368mm W x 200mm H (18 3/8" L x 14 1/2" W x 8" H)
 - (b) Satellite Antennas – 900mm L x 900mm W x 200mm H (36" L x 36" W x 8" H)
- (5) Amtrak shall inform the Contractor of the make and model of the exterior antenna and provide a template with the bolt pattern and cable port dimensions. Contractor shall procure and install all antennas.
- (6) The Contractor shall provide the diagrams of the antenna locations and the bolt hardware specification for Amtrak review and Approval **[CDRL 14-11]**

ii). RF Exterior Cable Design Requirements:

- (1) A total of forty-six (46) single-length (home-run) RF cables shall be installed between antenna locations and the MAR1 location.
- (2) Intermediate RF connectors shall not be used. RF cables shall be at least one-half inch (1/2"); commonly referred to as "400" antenna cabling) in diameter.
- (3) The cables shall support frequencies between 600MHz and 7125GHz.

- (4) Contractor shall install forty (32) cables connecting eight (8) 4x4 MIMO exterior cellular antennas (antennas #1 through #10) to the MAR1 location.
 - (5) Exterior antennas #1 and #8 support Wi-Fi and GPS in addition to 4x4 MIMO, and the Contractor shall provide cabling for GPS (one cable each) and Wi-Fi (two cables each) to antenna #1 and #8 from the MAR1 location.
 - (6) The location of all cable terminations shall be provided to Amtrak for an approval.
- iii). RF Exterior Cable Testing Requirements
- (1) Contractor shall test Cellular RF cables across 617MHz to 3.98GHz (the 4x4 MIMO cables). Wi-Fi RF cables shall be tested from 2400 – 2483MHz and 5150 – 7125MHz. GPS cables shall be tested from 1164 MHz to 1610 MHz.
 - (2) All VSWR results shall be 1.4 or less. All cable runs shall be tested when the cables are installed. GPS antennas will not be swept, but a load shall be used to test the installed GPS antenna cables. All VSWR results will be provided to Amtrak for approval.
 - (3) Contractor shall measure the insertion loss of all forty-six (46) RF cables. The insertion loss for each cable shall not exceed 2dB.
 - (4) Contractor shall test for return loss and distance-to-fault (DTF) for forty-four (44) RF cables after they are attached to exterior cellular and Wi-Fi antennas. The return loss value shall not exceed 13.7dB (VSWR 1.52).
 - (5) Contractor shall measure return loss values for the two (2) RF cables connected to GPS antennas with 50 ohm load only (no antenna). The insertion loss for each cable shall not exceed 2dB.
 - (6) Contractor shall confirm GPS/GNSS functionality from the MAR-end of the GPS cables by running a GPS program that validates GPS satellite signal strength, angles, acquisition, and counts.
 - (7) Contractor shall submit all test results to Amtrak for an approval. The test results for each cable shall be submitted to Amtrak as part of the vehicle history book.
- iv). RF Exterior Antenna and Cable Labeling Requirements
- (1) All exterior antenna cabling shall be labeled clearly on both ends of the wire, observable with less than 90° of cable rotation.
 - (2) The Wireless Internet naming convention for the exterior antenna cables is:

- (a) Prefix = Contractor cable number (as the Contractor convention requires)
 - (b) Underscore = use the '_' character between the prefix and origin
 - (c) Origin = MAR1 (port name not required)
 - (d) Destination = <-antenna name> with <-port name; when applicable> (see 12.6.1 for antenna and related port names)
- (3) For example, the label on the antenna cable which terminates at one end to MAR #1 and the other to exterior antenna 1 at the 4th cellular port shall read:
- Xxxxx-xxxx_MAR1-ANT1-P4
- (4) An antenna cable connecting MAR #1 and terminates at exterior antenna 6 Wi-Fi port 2 and is marked:
- Xxxxx-xxxx_MAR1-ANT6-WIFI2
- (5) Based on the previous example for MAR #1, a cable connected to the GPS port of antenna 10 is marked:
- Xxxxx-xxxx_MAR1-ANT8-GPS
- v). Ethernet Provisions for Exterior Antenna
- (1) To support the potential use of active roof-mounted equipment, the Contractor shall install an Ethernet cable meeting the requirements of 14.6 c.) between each antenna location and a SWITCH location.
 - (2) Cables between the exterior antenna locations shall be evenly distributed between SWITCH1 and SWITCH2.
- e). Interior Antennas and Cabling – Passenger LAN (PLAN)
- i). Interior Antenna Design Requirements
 - (1) Contractor shall mount a minimum of four (4) Huber & Suhner 1399.35.0020 Sencity Rail Omni-SR 6x6 MIMO Antennas (PLAN antenna) on the ceiling within each car.
 - (2) The Wi-Fi system (APs with PLAN antennas) shall provide RSSI coverage of –65dBm for 95% of the passenger and crew occupying areas in each car, including the restrooms, sleeping compartments, crew rest areas.
 - (3) With AP conducted power at 30dBm, RSSI shall measure less than -72dBm at 30 feet into the next car.
 - (4) Contractor shall conduct an RF propagation study to demonstrate the expected Wi-Fi coverage within the train car and the RF leakage to the

adjacent cars with AP conducted power at 30dBm (any IEEE 802.11ac Wave 2 or ax AP with four or more antenna leads may be used for the study). The location of all cable terminations shall be provided to Amtrak for an approval. **[CDRL 14-12]**

ii). Interior Cabling Design Requirements

- (1) RF cables connecting the APs and PLAN antennas shall be at least one-quarter inch (1/4-inch; commonly referred to as "240" antenna cabling) in diameter and shall not exceed three meters (3m) in length.
- (2) Contractor shall terminate RF cables with QMA-Male connectors on the antenna-facing side and connect the cables with PLAN antennas.
- (3) AP #1 connects to PLAN antenna 1 and 2, and AP #2 connects to PLAN antenna 3 and 4.
- (4) Amtrak shall inform Contractor on connector type required on AP-end of the cable termination at a later date.

iii). Interior Antennas and Cabling Testing Requirements

- (1) All PLAN antennas and cables shall be tested across Wi-Fi frequency bands between 2400 – 2483MHz and 5150 - 7125MHz.
- (2) Contractor shall measure the insertion loss of PLAN RF cables, and loss value shall not exceed 2dB.
- (3) Contractor shall measure return loss and DTF with PLAN cables attached to antennas. The return loss value shall not exceed 13dB (VSWR 1.6).
- (4) Contractor shall provide test all results to Amtrak for approval. The test results for each cable shall be submitted to Amtrak as part of the vehicle history book.

iv). Interior Antennas and Cabling Labeling Requirements

- (1) All PLAN antenna cabling shall be labeled clearly on both ends of the wire, observable with less than 90° of cable rotation. The Wireless Internet naming convention for PLAN cables is:
 - (a) Prefix = Contractor cable number (as the Contractor convention requires)
 - (b) Underscore = use the '_' character between the prefix and origin
 - (c) Origin = AP1 or AP2 (port name not required)
 - (d) Destination = <-PLAN antenna name> with <-port name> (see 12.6.1 for antenna and related port names)

- (2) For example, the label on the PLAN antenna cable connecting AP #1 and PLAN antenna 1 at port 4 shall read:

Xxxxx-xxxx_AP1-PLAN1-P4

- (3) A PLAN cable connecting AP #2 to PLAN antenna 4 port 2 and is marked:

Xxxxx-xxxx_AP2-ANT4-P2

v). Interior Antenna Cutsheet

- (1) The data sheet for the Huber & Suhner 1399.35.0020 antenna is linked here:

https://www.mouser.com/datasheet/2/829/HUBER_2bSUHNER_1399_35_0020_SeriesDataSheet-2581677.pdf

f). Power and Wiring

i). Wireless Internet Power Requirements

- (1) Sufficient power shall be provided to all components via WAGO or NEMA blocks (screw-type blocks supporting ring or fork connectors or friction connectors supporting tinned wiring between 12AWG and 18AWG are acceptable) for each equipment location.
- (2) Contractor shall provide a Wireless Internet circuit of no less than 650w per car, connected to a single 10-amp circuit breaker. The location of all cable termination shall be provided to Amtrak for an approval.
- (3) Contractor shall provide sense power cabling to MAR locations to support post-run delay timer implementations (not required if located in load-shed circuit).
- (4) In the event of 480V Head End Power (HEP) loss, power to all MAR locations shall remain by use of car side battery power.
- (5) Ground post locations and 300mm (12") straps shall be provided and identified with easily visible green indicators to attach at each equipment mounting location.
- (6) Amtrak shall provide leads connecting equipment to the WAGO or NEMA block at each equipment location.

ii). Power Wire Labeling Requirements

- (1) Wiring labels for power leads shall state their origin and destination on both ends of the wire and both sides of the label.
- (2) All power wiring shall be labeled clearly on both ends of the wire, observable with less than 90° of cable rotation. In the case of paired or

multi-conductor power wires, one label per conductor is required. The Wireless Internet naming convention for power cables is:

- (a) Prefix = Contractor cable number (as the Contractor convention requires)
 - (b) Underscore = use the '_' character between the prefix and origin
 - (c) Origin = BRKR or SENSE or <device name> (port name not required; see 12.6.1 for component names)
 - (d) Source Voltage = voltage (if present; voltages exist from origin breaker or sense, but no voltage from MAR1, just pos or neg)
Destination = <device name> (port name not required; see 12.6.1 for component names)
- (3) For example, the label on the 72V power cable and the negative lead from the Wireless Internet circuit breaker to MAR1 WAGO block is respectively marked:

Xxxx-xxx_BRKR-72V-MAR1

Xxxx-xxx_BRKR-NEG-MAR1

- (4) A positive and a negative power cable coming from MAR1 to the AP2 WAGO block would read respectively as:

Xxxx-xxx_MAR1-POS-AP2

Xxxx-xxx_MAR1-NEG-AP2

g). Equipment Locations

i). General Requirements

- (1) Contractor shall provide a volume of space for each piece of Wireless Internet equipment as identified in 12.6.1.
- (2) Each equipment location shall have one Ethernet link routed to the equipment location from each switch location; a total of two (2) Ethernet cables, labeled as described in c).iii).
- (3) The location of all equipment shall be provided to Amtrak for an approval.

ii). T2G Router/Mobile Access Router (MAR) locations

- (1) Contractor shall provide a volume of space for two (2) T2G/MAR routers (including cable bend radius) in each car:
 - (a) T2G Router/MAR = 400 mm W x 320 mm L x 255 mm H (16" W x 12 5/8" L x 10" H)

- (2) The two MAR positions shall be located within 300mm (12") of each other. Exterior antenna cabling (see 12.6.3.1) shall be routed to within 450mm (18") of the MAR locations.
- (3) The location shall be accessible with a stepladder and locked behind a common keyed trap-door, hinged panel, or in a cabinet.
- (4) Components shall be serviceable/removable from that location without removing train components/panels.
- (5) Load bearing specification per mounting position shall support 20 kg (44 Lbs.) and use no less than four (4) bolts.
- (6) Contractor shall provide the volume dimensions and train fixture bolt hole patterns.
- (7) A mounting plate/tray/bracket supplied by Amtrak shall be used to mount equipment into the trainset; safe lifting or removal of this equipment should be a one-person task and there shall be enough access space for two persons to work there simultaneously.

iii). T2G Radio and Satellite Locations

- (1) Contractor shall provide a volume of space for a T2G radio (T2G) and a satellite radio (SAT) in each end car as defined in 14.6.b).ii).
 - (a) T2G Radio - 300mm W x 200 mm L x 100mm H (12" W x 8" L x 4" H)
 - (b) SAT Radio - 355mm W x 430 mm L x 152mm H (14" W x 17" L x 6" H)
- (2) This space is for future use.
- (3) Contractor shall install only power and Ethernet cabling to this location.
- (4) T2G radios and satellite modems shall be placed in the ceiling within 2 meters of roof space not currently populated by antennas, facilitating future antenna installation.
- (5) The location shall be accessible with a stepladder and locked behind a common keyed trap-door or in a cabinet.
- (6) Components shall be serviceable/removable from that location without removing train components/panels.
- (7) Load bearing specification per mounting position shall support 10kg (22 lbs.) and use no less than 4 bolts.
- (8) Contractor shall provide the volume dimensions and train fixture bolt hole patterns.

- (9) A mounting plate/tray/bracket supplied by Amtrak shall be used to mount equipment into the trainset; safe lifting or removal of this equipment should be a one-person task and there shall be enough access space for two persons to work there simultaneously.

iv). AP Locations

- (1) Contractor shall provide a volume of space in the ceiling for two (2) AP radios in each car:
 - (a) AP - 273 mm W x 300 mm L x 100 mm H (10 ¾" W x 12" L x 4" H)
- (2) The location shall be accessible with a stepladder and locked behind a common keyed trap-door or in a cabinet.
- (3) Components shall be serviceable/removable from that location without removing train components/panels.
- (4) Load bearing specification per mounting position shall support 10kg (22 lbs.) and use no less than 4 bolts.
- (5) Contractor shall provide the volume dimensions and train fixture bolt hole patterns.
- (6) A mounting plate/tray/bracket supplied by Amtrak shall be used to mount equipment into the trainset; safe mounting or removal of this equipment should be a one-person task.

v). Switch Locations

- (1) Contractor shall provide a volume of space for switches that support two (2) switches (including cable bend radius) in each MAR Car:
 - (a) Switch - 300mm W x 430mm L x 255mm H (12" W x 17" L x 10" H)
- (2) The location shall be accessible with a stepladder and locked behind a common keyed trap-door or in a cabinet.
- (3) Components shall be serviceable/removable from that location without removing train components/panels.
- (4) Load bearing specification per mounting position shall support 10kg (22 lbs.) and use no less than 4 bolts.
- (5) Contractor shall provide the volume dimensions and train fixture bolt hole patterns.
- (6) A mounting plate/tray/bracket supplied by Amtrak shall be used to mount equipment into the trainset; safe lifting or removal of this

equipment should be a one-person task and there shall be enough access space for two persons to work there simultaneously.

Table 14-2 Equipment/Spacing Dimension References

#	Equipment	Qty	Location	Required Dimension	Remark
1	MAR	2	Interior	15" W x 12 ^{5/8} " L x 10" H	Volume Space
2	AP	2	Interior	10 ^{3/4} " W x 12" L x 4" H	Volume Space
3	Switch	2	Interior	12" W x 17" L x 10" H	Volume Space
4	T2G Radio	1	Interior	12" W x 8" L x 4" H	Volume Space (for future use)
5	SAT Radio	1	Interior	14" W x 17" L x 6" H	Volume Space (for future use)
6	T2G/SAT Antennas	1	Roof	36" L x 36" W x 12" H	Volume Space (for future use)
7	Exterior Antennas	10	Roof	18 ^{3/8} " L x 14 ^{1/2} " W x 8" H	Equipment
8	Ceiling Antennas	4	Ceiling	TBD	Equipment

h). Regulatory and Quality Validation

- i). The Contractor shall provide manufacturer cut sheets/datasheets for all cabling and equipment in consideration for this infrastructure design which includes the following specifications:
 - (1) Dimensions,
 - (2) Weight,
 - (3) Environmental (operating temperature/storage temperature/IP rating),
 - (4) Material Type,
 - (5) detailed RF parameters (operating frequency, insertion loss, and return loss) and
 - (6) Compliance/Regulatory.
- ii). If the manufacturer does not provide the data requested in their spec sheets, the Contractor shall seek the missing data from the manufacturer.

i). Modular Mounting Design

- i). Amtrak requires a modular mounting solution for all Wireless Internet equipment to facilitate rapid installation and removal.

- ii). The Contractor shall provide the load capacity, mounting dimensions, hardware specification, and train fixture bolt hole patterns for all MAR, T2G radio, SAT modem, AP, antenna (exterior and interior), and Switch spaces.
 - iii). Amtrak shall affix components to plates/trays/brackets based on these measurements and apply these fixtures at the time of installation.
- j). Test Requirements
- i). Contractor shall provide all test procedures/reports of the Contractor and Subcontractor tests for an approval.
 - ii). All test results shall be provided with each vehicle history book prior to the conditional acceptance.
 - iii). Additionally, both routine and qualification tests by the Contractor during or after the production shall be witnessed by Amtrak.
 - iv). Sub-contractor Testing:
 - (1) Specifications of the RF cable(s) in use including applicable mechanical, electrical and regulatory information.
 - (2) "Birth certificates" of the RF cables with run length, return and insertion loss measurements between 617MHz and 7125MHz shall be conducted if cables are pre-assembled outside of the contractor facility.
 - (a) If cables are assembled by the contractor, cable measurements shall be provided from post-installation testing described in 1.5.3.1. and "Birth Certificates" are not required, as all cable(s) not passing specifications, and rejected by Amtrak will be remanufactured on-site by the contractor.
 - v). Contractor/Production Testing (as a Routine Test):
 - (1) Continuity, Megger and Hi-pot shall be performed on all power wires.
 - (2) All Ethernet cables shall be certified to ISO/IEC 11801-1 - Class F (CAT7) with an appropriate cable certifier (Ex. Fluke DSX series).
 - (3) All Fiber cables shall be certified to ISO/IEC 11801-1 – OM3.
 - (4) RF Cable Analyzer (time and frequency domain reflectometer (Ex. Anritsu Sitemaster Series, Keysite Fieldfox Series, or Bird Sitehawk SK series)) shall be utilized to perform on all RF Cables as stated in below conditions. (See Table 14-3 for criteria)
 - (a) **Condition 1:** Without connecting to Antennas, measure and verify the 'return loss' and 'insertion loss':
 - (i) MAR to Roof-mount Cellular Antennas

- (ii) MAR to PLAN/Wi-Fi Antennas
- (iii) MAR and GPS Antennas
- (b) **Condition 2:** After connecting the connectors to Roof-mounted Cellular and PLAN/Wi-Fi Antennas, measure and verify the ‘return loss’ and ‘distance-to-fault (DTF)’. DTF parameters (speed of propagation, insertion loss, etc.) shall be programmed into cable analyzer to ensure accurate DTF measurements.
 - (i) MAR to Roof-mount Cellular Antennas
 - (ii) MAR to PLAN/WiFi Antennas
- (c) **Condition 3:** After connecting the connectors to Roof-mounted GPS Antennas, measure and verify the GPS satellite signal strength, angles, acquisition and counts as well as GPS/GNSS functionality. These shall be measured/confirmed by connecting the portable GPS receiver to MAR-end of the GPS cable and running the GPS program. Note that detailed pass/fail criteria and designated GPS program for Condition 3 will be provided during the design review.

Table 14-3 RF Cable Criteria

Frequency (MHz)	Measurement Granularity (no. of points)	Type of Antenna Connection
617 to 894	>3000	Cellular
1710 to 2700	>3000	Cellular
3300-3980	>3000	Cellular
2400-2483	>3000	PLAN/WiFi
5150-7125	>3000	PLAN/WiFi
1164-1610	>3000	GPS

14.7 Information Technology and Architecture

- a). Overview
 - i). Amtrak views real-time data from the trainsets a critical component of understanding and monitoring and proactively addressing safety issues, and meeting customer expectations.
 - ii). The ability to understand the health of trainsets in real-time is a critical component to ensure Amtrak can address safety, mechanical, operational, and customer service needs as the trainset is in service.
 - iii). All information technology hardware, software, and data shall fully comply with the Amtrak Digital Technology requirements identified in Chapter 26.

- b). Digital Architecture
 - i). The Contractor shall provide detailed architectural and design documentation for all digital assets and systems either on train or ground, including Information, Application, Networking, and Security.
 - ii). For software, platforms or systems operated on Amtrak's behalf, provide a high-level description of the environment, certifications, and incident response model as well example of Service Level Agreements and Operating Level Agreements for those managed systems.
- c). Data: Sharing and Analysis
 - i). The Contractor shall indicate what data is created from systems, either on the vehicle or on the wayside in order to support the vehicles.
 - ii). All data generated as a part of the operation or support of the Amtrak equipment shall be made available and accessible for Amtrak use/reuse.
 - iii). Data dictionaries, interpreters, and tools suitable for automated batch processing to open formats shall be provided to Amtrak such that the full fidelity of all data is accessible by Amtrak personnel and digital systems.
 - iv). The Contractor shall also indicate any ownership or legal restrictions on data generated on Amtrak trains.
 - v). The Contractor shall describe any digital models used to support predictive or conditional maintenance and whether those models are available for Amtrak use.
- d). Security Architecture
 - i). In addition to security requirements defined in Chapter 28, the Contractor shall provide detailed documentation for policies, processes, systems and tools utilized to secure all digital assets, systems, and networks either on the equipment or on ground.
 - ii). This documentation shall include audits and certifications completed by third parties to show compliance with Industry Standards.
 - iii). The Contractor shall indicate the type of COTS and OEM software being provided, including embedded systems, aboard the trainset, and the processes and mechanisms used to ensure all software is kept up-to-date and safe from a cybersecurity perspective.
 - iv). Security locks shall be used to protect communication equipment from unauthorized access. Square keys shall not be considered as an appropriate measure of security to prevent unauthorized access.
 - v). Network devices shall not be installed in lavatory or sleeper compartments, or other areas that are not subject to video surveillance.

- vi). Access to the network shall require authentication, and the network shall be designed with security network zoning principles per IEC 62443 and TS 50701
- vii). PTUs should have endpoint protection where capability exists and should enforce authentication.
- e). Train Control Systems, IOT and Data
 - i). The Contractor shall indicate the types of onboard sensors and devices used to generate data to support either real-time or analytical data.
 - ii). The Contractor shall indicate if they have integrated external data such as Track Wayside Detectors into their management and analytics solutions.
 - iii). The Contractor shall indicate whether a GPS signal can be sent in real time to Amtrak to support accurate trainset movement for Amtrak customer channels and operational needs.
- f). Onboard Train Information System (OTIS)
 - i). The Contractor shall provide detailed application and design documentation for all Onboard Train Information Systems deployed to communicate with passengers and employees including deployment, integration, information, and security requirements for all ground systems.
 - ii). This documentation shall include how content is created, managed, distributed and controlled.
 - iii). The Contractor shall indicate types of signage onboard the train, indicate Amtrak's ability to affect the digital signage, and whether digital signage has been provided to support Food Service sales.
- g). ADA Compliance for All Passenger Information/Interaction Systems
 - i). All Onboard Information Systems shall comply with the latest ADA standards at time of delivery and detailed documentation shall be provided to verify compliance as well as ongoing support and maintenance.
- h). Data Integration
 - i). Integration and data sharing are a critical component of success in ensuring Amtrak can deliver services safely and successfully to its customers.
 - ii). The Contractor shall identify how they have integrated data from railcar to customer.
 - iii). The Contractor shall provide application descriptions and high-level design/integration documents for ground systems that will integrate with Amtrak.
 - iv). These documents must include deployment, integration, information, and security requirements for all trainset and ground systems.

- v). The Contractor shall indicate if they have integrated with platforms such as SAP, Maximo, Kronos and Adobe Experience Manager.
- i). Software Updates, Training, and Licensing
 - i). The Contractor shall indicate how any software that is part of trainset and support equipment will be updated, including processes used to ensure software flaws, bugs, and obsolescence are mitigated.
 - ii). For all software, the Contractor shall indicate if training is necessary and any training required.
 - iii). The Contractor shall indicate the type of license used for all software provided (perpetual/subscription).
 - iv). The Contractor shall indicate how Amtrak will retain the right to use and provide updates to software in the event the Contractor or software is purchased by a different entity.
- j). Safety Data Collection and Sharing
 - i). The Contractor shall provide detailed application and design documentation for all systems utilized in the collection and distribution of Safety related information, including Operational Telemetry, Video and other communications required to monitor and manage Safety Systems and processes.
 - ii). The Contractor shall indicate whether this information is available in real-time and how data will be made available to Amtrak.
- k). IT Systems to Support Maintenance
 - i). The Contractor shall describe the Ground Systems recommended or required to support the operation, maintenance and repair of the trainsets.
- l). Interface with Passenger and Crew Applications
 - i). The Contractor shall provide on-board APIs that facilitate secure access to communication system functions that enable the development of handheld device applications that interface with or receive information from the onboard communication system.
 - ii). The on-board APIs shall be secure, with credentials and API keys configurable to support many users, with different authorizations.
 - iii). The intended use for on-board APIs include:
 - (1) crew applications, which, through the Contractor supplied API, shall be capable of the command and control of the communication system functions including:
 - (a) Setting and adjusting routes

- (b) Making manual PA announcements (including graphics visual, text, and audio)
 - (c) Selecting pre-loaded special messages to play
 - (d) Answering PEI calls
 - (e) Making and receiving intercom calls, including general calls, calls to specific intercom clients, and call to specific cars
 - (f) Answering Attendant Call requests, resetting attendant calls, and configuring the attendant call functionality
 - (g) Configuring the reservation display system
 - (h) Viewing system, car, and train status and diagnostic information
 - (i) and other system functions identified by Amtrak during the design review process
- (2) Passenger applications, which, through the Contractor supplied secured API, shall support:
- (a) The capability to display and playback onboard announcements and current train
 - (b) The capability to display route information.
 - (c) The capability to display the consist configuration, individual car amenities, and current location in a car and train
 - (d) and other communication system features identified by Amtrak during the design review process
- (3) The method of communication and control shall be secure, with configuration and security considerations identified during the design review.

14.8 Ethernet Train Backbone (ETB) and Ethernet Car Network (ECN)

a). General

- i). The ETB is used to control and transmit communication information throughout a passenger train consists of between 2 and 22 vehicles and locomotives.
- ii). The ETB shall carry information along multiple paths between adjacent vehicles.
- iii). The ETB is designed to have no less than 1 Gbps of bandwidth when using the wired network for purpose of managing the traffic across the network.

- iv). All cabling and connectors used for the ETB shall support speeds of 10 Gbps.
 - v). The IP addressing scheme of all onboard IP networks shall be based on EN 61735. The IP addressing scheme, and a list of all IP devices shall be submitted for review and approval by Amtrak. **[CDRL 14-13]**
 - vi). The Contractor shall provide a description of the ETB and ECN control and architecture for Amtrak review and approval. The description shall include details of the data network protocols, fault tolerance, degraded operating modes, redundancy arbitration, and a description of network initialization and configuration. **[CDRL 14-14]**
- b). Equipment
- i). The network architecture, network protocols, and all interfaces between all network components located on or off the car shall be non-proprietary. The use of proprietary protocols is prohibited.
 - ii). Network Interface Control Documents shall be submitted for Amtrak review and approval for all onboard and wayside interfaces between any two software executables. **[CDRL 14-15]**
 - iii). The ETB equipment is required to provide a high availability of the overall train network, so the system shall ensure that failure of a single active component or power failure within one vehicle shall not interrupt the ETB functionality for the remainder of the train.
 - iv). The ETB shall remain operational on battery power while in Standby operation.
 - v). All hardware should be adapted from PRIMA 305-919.
 - vi). All IP Switches shall be managed, and shall support:
 - (1) Ethernet Frame Switching as per IEEE 802.1D
 - (2) Quality of Service as per IEEE 802.1Q
 - (3) Virtual Local Area Network as per IEEE 802.1Q
 - (4) Link Layer Discovery Protocol as per IEEE 802.1AB
 - (5) Switches shall provide sufficient buffering and queuing capability to avoid network bottlenecks.
- c). Ethernet Train Backbone (ETB) Switches
- i). At least two managed railway grade Layer 3 Ethernet Train Backbone switches shall be installed in each end of the vehicle for the ETB OTIS, PA Communications, car diagnostic systems, and other operations-critical systems use.

- ii). The switches shall incorporate bypass contacts to be capable of allowing the Ethernet signals from adjacent vehicles and switches to pass through them when they fail or lose power.
 - iii). The Contractor shall provide ETB switches that manage link redundancy and maintain network communications in the event of a link failure.
 - iv). The switches shall conform to the requirements of EN61375-2-5:2014.
 - v). Ethernet switches shall be mounted inside at each end of the vehicle near the locations where the jumper receptacle cables enter the vehicle, or at a location approved by Amtrak.
 - vi). One additional pair of switches, supplied by Amtrak as a part of the passenger wireless internet system, will be utilized for the passenger Wi-Fi and Entertainment system.
 - vii). Ethernet Train Backbone switches shall communicate successfully with other ETB nodes without limitation as to the sequence or orientation within the train, and without a requirement for manual configuration.
- d). Ethernet Car Network Switches
- i). Ethernet Car Network switches shall be connected to each other through a Gigabit speed fault tolerant ring topology to form the Ethernet Car Network (ECN).
 - ii). The ECN shall be connected to the ETB switches through redundant Gigabit speed links.
 - iii). When ECN nodes are replaced, the network system shall automatically identify the replacement equipment, and its communication links. Replacement of any subsystem controller or network switch shall not require any manual configuration of the controller or switch.
- e). Cabling and Connectors
- i). Eight Cat 6A Ethernet cables are installed within a direct conduit along the length of the vehicle to connect the switches at each end of the vehicle together.
 - ii). Details shall be provided during design review.
 - iii). The Ethernet terminations on both Ethernet switches and on the ends of the cable receptacles shall be fitted with four-way M12 connectors utilizing D-Coding for fast Ethernet and eight-way X-Coded for Gigabit or 10 Gigabit Ethernet.
- f). System Interconnection
- i). The trainset ETB shall at a minimum include eight category 6A cable end-to-end.

- ii). Wi-Fi and Passenger entertainment systems defined in TS 12.6 shall utilize switches and cabling as defined in that Chapter.
- iii). The passenger WiFi and Entertainment system shall be connected end-to-end utilizing at a minimum four dedicated Ethernet cables of the Ethernet Train Backbone.
- iv). All remaining car systems including OCUs, PA Control Panels, OTIS displays, system controllers and other devices shall utilize this network.
- v). Devices involved in the PA system shall have cables routed directly to the network switches.
- g). ETB External Hardware
 - i). The components of the exterior vehicle-to-vehicle network are the fixed receptacles, receptacle housings, bulkhead connectors and jumper cables.
 - ii). Each car within the trainset shall have one ETB headers located on each corner.
- h). Bulkhead Connectors
 - i). Each Fixed Receptacle will be pre-wired with two category 6A cables.
 - ii). Each of the category 6A cables shall be terminated with an eight-way X-Coded bulkhead M12 connector.
 - iii). Cables shall be routed in such a way that they are protected from EMI.
 - iv). The Fixed Receptacle shall be secured to the vehicle to ensure that the Ethernet Jumper attaches at an angle of approximately 15 degrees from vertical.
 - v). The center line of the fixed receptacle mounting junction box shall be 60 in. from TOR and 31.25 in. outward from the vehicle longitudinal center line.
 - vi). Alterations to this placement must be approved by Amtrak.
 - vii). For car-to-car interfaces Position 1 of each bulkhead shall be connected to the nearest Wi-Fi and Entertainment switch.
 - viii). Position 3 of each bulkhead shall be connected to the nearest car system switch.
 - ix). Positions 2 and 4 of the bulkheads shall remain empty for future expansion.
- i). Jumper Cables
 - i). For car-to-car interfaces each jumper shall be composed of four Category 6A or Category 7 cables and shall be long enough to support a car-to-car connection while the car is tuning at the greatest angle of turn the vehicle is rated for.

- ii). Each cable will provide bandwidth that is at least 10 Gbps.
 - iii). Each end of the jumper cable is designed to allow free movement, with a horizontal 270-degree arc of the mating face, in relation to the cable jumper to prevent excessive force on the jumper either when being mated to the vehicle or during normal vehicle movement.
 - iv). The jumper pulling failure force should be no greater than 100kg-ft which shall be less than the strength of the attachment of the receptacle housing to the carbody.
- j). Integration and Fault Tolerance Testing
- i). The contractor shall perform a Network Interface Card (NIC) test for each end station and each switch to verify compliance with IEEE standards.
 - ii). The Contractor shall perform a complete network integration test of all train subsystems, including transmission through jumper cables, to pre-qualify the proposed architecture of networks before vehicle implementation.
 - (1) This test shall consist of a simulated train with all train switches, actual cable and cable length, pins, and connectors that will be used on the vehicles.
 - (2) All intelligent system controls connected to the on-board networks shall be the actual units for one car of each type.
 - (3) The tests shall verify that all protocols, datasets, and messages used on all networks correspond to the Network Interface Control Document and the specific signal, message, and dataset documentation provided for each network.
 - (4) At the time of the integration tests, the Contractor shall demonstrate the fault tolerance of all networks by simulating all possible faults.
 - iii). Amtrak shall have the option of witnessing the tests.
 - iv). The test procedure **[CDRL 14-16]** and results **[CDRL 14-17]** shall be submitted to Amtrak for review and approval.
- k). Protocol Analyzer
- i). The Contractor shall provide a laptop-based Protocol Analyzer for Amtrak use to perform real-time monitoring of network activity on all networks provided under this contract. The Protocol Analyzer shall have the capability of:
 - (1) Displaying data in engineering units
 - (2) Setting of capture filters to limit the recording of telegrams and network packets to only the ones that are targeted

- (3) Providing a visualization of the protocol stack in adjustable levels of detail
- (4) Developing and displaying statistical reports on traffic, errors, protocol types, etc.
- (5) The Contractor shall submit for Amtrak review and approval the capabilities of the Protocol Analyzer for each Network **[CDRL 14-18]**

14.9 Electromagnetic Interference

a). General EMI / EMC Requirements

- i). All carborne supplied equipment and its wiring shall be electromagnetically compatible and have no negative impact on, nor suffer from a negative impact from the use of:
 - (a) All other components on the cars
 - (b) All components of the communication system
 - (c) Operational electronics used by crewmembers, including radios, wireless ticketing devices and others
 - (d) Consumer electronics used by passengers, including cell phones, computers, radios and others
 - (e) Wayside equipment including signaling systems
- ii). The Contractor shall develop an Electromagnetic Compatibility (EMC) control plan, which shall describe the methodology used to measure control and mitigate all the Electromagnetic Interference (EMI) emissions by the supplied equipment.
- iii). This plan shall be submitted to Amtrak as part of the PDR for the communication system. **[CDRL 14-19]**

14.10 CDRLs

CDRL	Description	Due
CDRL 14-01	The Contractor shall identify the fault tolerance capabilities, recovery time, and user interaction required to maintain system operation.	30 days prior to PDR
CDRL 14-02	Plan identifying the approach to reducing the attenuation of the car-body, on-board equipment, and glazing impact on cellular telephone reception	30 days prior to PDR
CDRL 14-03	Documentation and calculations for all individual components, and for the system as a whole, demonstrating the conformance to the requirements in this technical specification and referenced standards.	30 days prior to PDR
CDRL 14-04	Detailed design of the Hospitality TV Provisions	30 days prior to PDR

CDRL	Description	Due
CDRL 14-05	RFID keying system design, arrangement, and security consideration for the manual override key	30 days prior to PDR
CDRL 14-06	Surveillance camera coverage plan	30 days prior to IDR
CDRL 14-07	Comprehensive architecture and design package	30 days prior to PDR
CDRL 14-08	Documentation defining the capabilities of the OTIS self-test functions	30 days prior to PDR
CDRL 14-09	Document identifying the standard interface which would allow the integration of a replacement or additional DCS communications channels	30 days prior to PDR
CDRL 14-10	Design of the Provision for Wireless Internet	30 days prior to PDR
CDRL 14-11	Diagrams of the antenna locations and the bolt hardware specification	30 days prior to IDR
CDRL 14-12	RF propagation study	30 days prior to IDR
CDRL 14-13	The IP addressing scheme, and a list of all IP devices shall be submitted for review and approval by Amtrak.	30 days prior to PDR
CDRL 14-14	Description of the ETB and ECN control and architecture	30 days prior to PDR
CDRL 14-15	Network Interface Control Documents	30 days prior to IDR
CDRL 14-16	Integration and Fault Tolerance Testing Procedure	30 days prior to IDR
CDRL 14-17	Integration and Fault Tolerance Testing Report	30 days prior to FDR
CDRL 14-18	Capabilities of the Protocol Analyzer for each Network	30 days prior to PDR
CDRL 14-19	Electromagnetic Compatibility (EMC) Control plan	30 days prior to PDR

* End of Chapter 14*

Amtrak Long Distance Bi-Level Fleet Replacement

Technical Specification

15. Electrical System

Revision 1

Table of Contents

15.1	Overview	15-1
15.2	General Requirements	15-1
15.3	Trainline Systems for Communication and Multiple Unit Wiring	15-3
15.4	Digital Networks	15-7
15.5	480 VAC Head End Power (HEP) Trainline System	15-11
15.6	480VAC Power Distribution	15-15
15.7	120VAC Power Distribution	15-16
15.8	Battery Charger	15-18
15.9	Battery System.....	15-23
15.10	DC Power Distribution System.....	15-27
15.11	Electrical Panels.....	15-28
15.12	Spare Conduit	15-30
15.13	Car Location Identifiers for All Subsystems	15-30
15.14	Integrated Schematics.....	15-30
15.15	CDRLs.....	15-35

15.1 Overview

- a). This Chapter describes the major electrical power distribution and control systems required for the overall trainset and locomotive-to-trainset power and signal trainline circuits.
- b). The locomotive-to-trainset systems include 480V Head End Power (HEP), Digital Trainline (DTL), 27-point door control/communications and 27-point locomotive control trainlines (MU).
- c). Alternative inter-car trainline connection arrangements can be proposed for review and approval.
- d). The trainset systems may include:
 - i). 480 Volt Alternating Current (VAC) HEP trainline and power distribution,
 - ii). 208VAC power distribution,
 - iii). 120VAC power distribution,
 - iv). 74 VDC Low Voltage Power Supply (LVPS) power distribution,
 - v). battery,
 - vi). 27-pin trainlines for car-to-car multiple unit (MU) and communications (COMM), and
 - vii). electrical locker circuit breaker panels.
- e). It is intended that all cars of the trainset be configured with these standard trainlines or an agreed upon alternative design to permit flexibility in length and interchangeability of cars.
- f). Consists may be configured in trainsets up to 1870 ft in length. All trainset functions shall operate per the standards of this specification within this train length range.
- g). Trainline functions may operate at reduced levels (tolerance to be approved by Amtrak) at consist lengths greater than 1870 ft (due to trainline voltage drop).

15.2 General Requirements

- a). Hotel power to the trainset shall be provided through trainline cables from an external 480VAC, 3-phase, 60 Hertz (Hz) source not located on the vehicles.
- b). The system shall be designed for normal operation using power supplied by a locomotive HEP source, or from a wayside 480VAC power source that can have a tolerance up to -15% to +10%. See 15.5 for additional phase imbalance requirements.
- c). Each car within the trainset shall be equipped with 27-point locomotive control (MU), 27-point communication (COMM), and digital (DTL) trainline receptacles

- connected at each end of the carriage unless otherwise approved by Amtrak.
- d). All trainline wires shall run the entire length of each car and be connected from end-end.
 - e). Carriages shall be connected using standard jumpers throughout the trainset.
 - f). The primary communication trainline within the trainset shall be one or more IP Ethernet based digital trainlines.
 - g). All electrical systems and components utilized on the trainset and all of its cars shall be electromagnetically compatible with other electrical systems and components, including but not limited to:
 - i). crew radio,
 - ii). digital train line,
 - iii). ECP cabling (see Chapter 9 for additional information),
 - iv). on-board train information system,
 - v). on-board lighting,
 - vi). passenger wireless devices and
 - vii). laptop computers.
 - h). The electrical power distribution and all subsystem equipment shall be in accordance with all applicable FRA regulations, APTA standards (including but not limited to PR-E-RP-002-98, PR-E-RP-004-98, PR-E-S-005-98, PR-E-RP-007-98, PR-E-RP-009-98), IEC/EN railway standards (including but not limited to EN 50155, EN 50121-3-2, IEC 60601-2-33, and associated referenced standards), IEEE standards including IEEE Standard 16-2020 or latest version, and other recommended practices and industry standards.
 - i). In the event APTA standard couplers, air brake hoses, or passenger car Head End Power/Communications/locomotive MU control electrical trainlines are used inter-car, the connections must meet all applicable AAR, APTA, and Amtrak standards.
 - i). All materials and workmanship shall comply with Chapter 19.
 - j). Terminal blocks, connectors, and other car wiring devices shall be accessible for inspection, troubleshooting and re-terminating. There shall be no equipment blocking access that must be disassembled or removed.
 - k). Terminal blocks and connectors shall not be located on the floor.
 - l). As a supplement to APTA PR-E-RP-002-98 pertaining to wiring of passenger equipment:
 - i). Unterminated wire connections to terminal blocks are prohibited

- ii). All terminal blocks where the manufacturer states that terminals can be used with or without ferrules, all wires shall use crimp-type ferrules.
- iii). Flexible conduit located exterior to the carbody shall be liquid-tight flexible metal conduit. Non-metallic conduit exterior to the carbody is prohibited.
- iv). Non-metallic conduit shall not be used unless approved by Amtrak before Final Design Review.
- m). Ribbon cable connections are prohibited.
- n). Underframe junction box, conduit, cabling, and other equipment shall be adequately protected from debris strikes, snow and ice while traveling forward or reverse.
- o). Any non-metallic enclosures or components located in the underframe shall be minimized. If used, they shall have additional stainless steel debris shields that will not accumulate debris, snow or ice while traveling forward or reverse.
- p). All power supplies, controllers, motors, and other electronic devices shall report fault information to the car diagnostic system. Microprocessor-based devices shall communicate via the Ethernet Car Network to the car diagnostic system. Simple, non-microprocessor-based devices shall provide health and fault status via discrete outputs to the car diagnostic system, or Amtrak approved alternative.

15.3 Trainline Systems for Communication and Multiple Unit Wiring

- a). General
 - i). Locomotive-to-trainset communication for MU and COMM shall be provided by 27-point plugs and receptacles.
 - ii). If alternative inter-car trainline connection arrangements are proposed, each car shall have the following requirements:
 - (1) All cars shall have provisions to install 27-pin COM, 27-pin MU, and PRIAA Specification 305-919 DTL receptacles.
 - (a) All cars shall have the 27-pin MU receptacles installed and wired.
 - (b) End cars shall have the 27-pin COM and DTL receptacles installed and wired.
 - (c) Inter-car ends shall have covers and gaskets to seal the 27-pin COM and DTL receptacle provisions.
 - (d) There shall be reserved conduits or wire trays to allow a straightforward retrofit of a non-end car in the center of the trainset, to an end car receptacle configuration.

- (2) Connections shall be made car-to-car within the trainset using receptacles and jumper cables similar to Harting HPR VarioShell with associated cable management, or Amtrak approved equivalent.
 - (a) Receptacles shall be rated to IP66 or better.
 - (b) Jumper cables shall allow installation and removal without the use of hand tools in under 15 minutes. Jumpers shall be maintainable by a 50th percentile female wearing gloves and working at ground level.
 - (c) All hardware must be captive.
 - (d) Inter-car components shall be proposed at preliminary design review for Amtrak review and approval. **[CDRL 15-01]**
 - iii). The trainline system shall be compatible in function with APTA Recommended Practice PR-E-RP-017-99.
 - iv). The 27-point COMM, 27-point MU, DTL, and 480VAC HEP trainline control circuits shall each be run in separate conduits or wire trays.
- b). Communication Trainline
- i). The COMM trainline provides trainset-to-locomotive and trainset-to-car connections for systems such as door control, door closed summary circuit, public address, passenger information and brake status lights.
 - ii). Trainline pin assignments are shown in APTA PR-E-RP-017-99. See Table 15.1.
 - iii). The primary communication trainline within the trainset shall be the digital trainline. When coupled with legacy equipment, the trainset shall automatically provide relevant functionality using the legacy COMM communication connections.
- c). End of Train Functions
- i). There shall be physical switches that can quickly configure a car as a non-end car, or an end car. These switches shall be located inside the electric locker and have provisions to attach switch seals.
 - (1) When the switch(es) are in “inter-car” position, all of the power and signal trainlines shall pass through the main car trainline jumpers.
 - (2) When the switch(es) are in “27-pin” position, then 27-pin COMM, MU, and DTL receptacle functionality will be configured. In this position all end of train circuit information shall be short-looped without the need for external jumper cables.
 - (3) There shall be a consistency circuit and diagnostic monitoring that can verify the position of this switch and compare it to the trainline receptacle configuration. For example, if the car is physically wired as

- an "inter-car" and does not use 27-pin receptacles and jumpers, or is detected by the train network to be in a non-end position, and the End-of-Train switch is in position "27-pin", then a fault shall be reported to the diagnostic system for incorrect end of train configuration identifying the car number and details of the incorrect configuration.
- (4) Short looping jumper cables shall be allowed as an emergency option in case there is a failure with the End-of-Train switch functionality.
- ii). To provide end of train circuit information, depending upon the trainset configuration, at the end cars of the trainset a jumper cable may be connected between the right side COMM receptacle and an adjacent white dummy COMM receptacle, to provide end-of-train detection for on-board systems such as the door closed summary circuit.
 - iii). Looping relays shall be provided for each car of the trainset to establish "end of train" for the four communication trainline circuits (#19, #20, #23 and #26).
 - (1) The looping relay shall be energized when the 27-pin COMM jumper is connected between the COMM receptacle and the adjacent dummy receptacle.
 - (2) Alternate methods may be proposed to Amtrak for approval.
 - iv). The DTL system shall be capable of establishing end-of-train functionality to be used in place of the COMM dummy functionality for train summary circuits in the future.
 - (1) The DTL system shall be capable of handling all existing COMM functions that are not safety-relevant.
 - (2) The contractor may propose an alternative approach if a known solution will better suit Amtrak's design requirements.
- d). Multiple Unit (MU) Trainline
- i). In push-pull operation, locomotive control functions shall be transmitted through the train from the trainset end car, cab car, or another locomotive by means of a standard AAR MU trainline.
 - ii). A single MU jumper cable (commonly 71 in. long) shall be used between the locomotive and the adjacent end car of the trainset, using the trainline pin assignments shown in Table 15.2.
 - (1) Car-to-car connections do not need to use the same pin assignments as 27-pin MU jumpers, however the wiring should be grouped together to facilitate simple receptacle configuration changes if an inter-car end is changed to a 27-pin end.
 - (2) End 27-pin receptacle placement shall be arranged to maintain a common 71 inch long MU jumper cable and not require special jumper cables to be used between this trainset and existing locomotive.

- iii). All MU trainline receptacles and functions shall conform to APTA PR-E-RP-017-99.
 - iv). Each MU trainline wire shall be pass-through, uninterrupted from end to end. There shall be no switching or disconnect device that can open the MU trainlines.
- e). Trainline System Application to Vehicles
- i). Two digital trainline receptacles shall be installed on each end of each car in accordance with PRIIA Specification 305-919.
 - ii). In addition, two sets of COMM and MU receptacles shall be installed on each end of all cars, one on each side of coupler pocket per APTA Recommended Practice RP-E-017-99.
 - iii). One MU and one COMM 27-point jumper cable shall be connected between the trainset and the locomotive.
 - iv). One or more dummy COMM receptacles may be required at the end of each car to ensure compliance with section 15.3.
 - v). Alternative locations for these receptacles may be proposed to Amtrak for approval.
 - vi). The plate to which receptacles and jumper flanges are mounted shall be designed to resist a 500-pound force, without deforming, produced by pulling the locked jumper (with the receptacle cover locked down utilizing a rubber-O ring type retainer) out of the receptacle.
 - vii). There shall be no interference that restricts the receptacle cover from being fully opened to allow insertion or withdrawal of jumpers.
 - viii). Under all operating conditions, a minimum of 2 in. clearance for the trainline cables shall be provided between trainline jumpers and the carbody and all appliances including air hoses, couplers, uncoupling levers and other equipment.
 - ix). Each trainset shall be delivered with one loose jumper cable of each type for each connection that would need to be made.
- f). Trainline Junction Boxes
- i). Separate stainless steel weatherproof junction or switch boxes shall be provided at each end of each car within the trainset for the communication (both DTL and COMM) and MU trainline systems.
 - ii). Trainline junction boxes shall be located behind the F-end truck or other Amtrak approved protected location.
 - iii). The inside of any exterior-mounted box shall be powder coated with an insulating paint or varnish.

- iv). All wires shall be terminated using Amtrak approved termination method mounted onto terminal blocks in the junction boxes.
- v). Trainline junction boxes shall be located where they are shielded from roadbed debris and car system liquid drains.
- vi). All trainline junction boxes shall be weatherproof to NEMA4 requirements or IP56 if located on the exterior.
- g). Additional Trainline Signals
 - i). Amtrak requires three additional trainline functions that are not currently allocated in the 27-pin COMM trainlines. These three functions shall be realized by other means on a per car basis, and then communicated to the locomotive.
 - (1) Hot Journal bearing from any vehicle,
 - (2) Locked Axle from any vehicle,
 - (3) Fire/Smoke indication from any vehicle
 - (4) Any other signal that cannot be transmitted by car network

15.4 Digital Networks

- a). General
 - i). Ethernet/IP (Internet Protocol) shall be the medium of communications between systems (HVAC, LVPS/BC, doors, communications system components, event recorder, cameras, brake system, etc.) inside a car and between cars that make up a train consist.
 - ii). A Car Ethernet Network, based on IEC 61375-3-4, shall provide communication for the devices / sub-systems within the car. It should provide programmable real time data monitoring information.
 - iii). An Ethernet Train Backbone, based on IEC 61375-2-5, shall be provided for communication between vehicles in the train.
- b). Car Ethernet Network
 - i). The primary communication method between on-board microprocessor controlled subsystems is to be via a Car Ethernet Network. All systems and subsystems on-board the vehicle are to be connected by way of a Car Ethernet Network.
 - ii). The Contractor shall provide a list of all IP devices on the Car Ethernet Network and Ethernet Train Backbone. The IP addressing scheme, to be approved by the Project Manager, shall be based on ENI EC 61375.
 - iii). The network design of the Car Ethernet Network and Ethernet Train Backbone shall be non-proprietary. The network design should include

protocols, such as those defined by TCN Open TRDP, that facilitate the addition and subtraction of components without requiring modifications to on-board software configuration items.

- iv). The Contractor shall provide a description of the Car Ethernet Network control and architecture to the Project Manager for review and approval. This description shall include detail on the data network protocols, fault tolerance, degraded operating modes, redundancy arbitration, error detection, and a description of network initialization and configuration.
- v). All networks (including the ETB) shall be based on the seven (7) layer open systems interconnection (OSI) model. Full documentation of each layer for each network shall be provided in a network interface control document to be submitted prior to the preliminary design review. The document shall be updated with all changes through testing and the end of the warranty period. **[CDRL 15-02]**
- vi). Subsystem monitoring and control within the car shall be primarily by means of the Car Ethernet Network with minimal use of discrete control wires for non safety-related functions. Systems controlled (non safety-related functions) and/or monitored by the Car Ethernet Network shall, at a minimum, include the following:
 - (1) Door System
 - (2) HVAC System
 - (3) Brake System
 - (4) LVPS/BC System
 - (5) Lighting System
 - (6) PA Amplifiers
 - (7) Signs
 - (8) PEIU
 - (9) Communication System Components
 - (10) TWC Gateway
 - (11) Video Surveillance Systems
 - (12) Water and Waste System
 - (13) Monitoring and Diagnostics System
 - (14) Maintenance Display Units
- vii). The Contractor shall perform a network interface card (NIC) test of each networked device to verify compliance with IEEE standards.

- viii). When nodes on the network are replaced using parts supplied by the Contractor or equipment supplier, the network system shall automatically identify the replacement equipment and its communication links. Replacement of networked subsystem controllers shall not require any configuration of the controller or vehicle/train switches.
 - ix). For the purposes of network maintainability and diagnostics, full per interface statistics of each network connected device shall be available via PTE, on-board diagnostic screen and wayside diagnostic system. The interface statistics shall include, at a minimum, packets transmitted, received, transmitted errors (broken down by type), received errors (broken down by type), packet types (unicast, multicast, broadcast, etc.), as well as interface connection duration, speed, and resets. The counters shall be capable of being reset on a per-interface basis via PTE, on-board diagnostic screen and wayside diagnostic system.
 - x). The PTE Ethernet port shall be located in an electrical locker in each car. Location to be determined during design reviews. A device shall provide the display of the network statistics showing an overview of the activities of the devices connected to the network and indicate issues such as interfaces which have a high number of errors and resets.
 - xi). The Contractor shall test to ensure each Car Ethernet Network channel link satisfies the complete Cabling Transmission Performance and Test Requirements of TIA/EIA 568-B.2, utilizing a device that meets the accuracy requirements of a Level III tester. Tests shall be performed each time a cable is replaced or re-terminated through test and warranty. Test results shall be recorded by the Contractor and provided to the Project Manager in a spreadsheet format for each car.
 - xii). The network diagnostic capabilities shall be submitted to the Project Manager for review and approval.
 - xiii). All software configuration items installed on any network connected device shall be maintained by an onboard controller to facilitate component replacements. A report of expected and current onboard software versions shall be accessible through the PTE, onboard diagnostic system, and wayside diagnostic systems. A software update command using a copy available on the update controller shall be available to maintainers when the report indicates that an expected version of a software configuration item is in conflict with the installed version on the network device.
- c). Ethernet Train Backbone / ETB
- i). General
 - (1) Communication between cars shall be implemented via a Gigabit Ethernet Train Backbone based on IEC 61375-2-5 that provides high speed trainline communication between cars, and between the cars and the wayside.

- (2) The Contractor shall provide a description of the Ethernet Train Backbone control and architecture to the Project Manager for review and approval. This description shall include detail on the data network protocols, fault tolerance, degraded operating modes, redundancy arbitration, error detection, and a description of network initialization and configuration.
- (3) An Ethernet Train Backbone Node (ETBN) shall be provided on all cars to provide routing between the ETB and the Car Ethernet Network. Each ETBN shall be implemented to provide link redundancy.
- (4) The ETB configuration, receptacles, and jumpers shall be implemented. Two Category 6A or Category 7 cables (one in use, one for future provision) shall be run from the ETB receptacles to the location of the Ethernet Train Backbone Node.
- (5) The ETB shall provide and support communication of data required to perform the following functions:
 - (a) Recognition of the train consist, including vehicle order, orientation, and number within the consist
 - (b) Automatic reconfiguration of the network when cars are coupled or uncoupled
 - (c) Trainset monitoring and diagnostics
 - (d) Train-to-wayside (TWC) data transfer
 - (e) Transfer of data needed from/by other ETB capable cars or locomotives in the consist
 - (f) Remote PTE/PTU access to Car Ethernet Network attached devices
- (6) The ETB shall support all of the diagnostic and monitoring functions of the monitoring and diagnostic system.
- (7) The cars shall be capable of operating in a consist with between 2 and 22 vehicles.
- (8) The Contractor shall test to ensure each Ethernet Train Backbone channel link satisfies the complete Cabling Transmission Performance and Test Requirements of TIA/EI 568-C.1 for Category 6A (CAT6A) cables and the 1000BASE-T link transmission performance requirements specified in IEEE Std 802.3. Tests shall be performed as per TIA/EIA 568-B.2, utilizing a device that meets the accuracy requirements of a Level III tester. Tests shall be performed each time a cable is replaced or re-terminated through test and warranty. Test results shall be recorded by the Contractor and provided to the Project Manager in a spreadsheet format for each car.

- d). Interoperability
 - i). The ETB, and systems utilizing the ETB and Car Ethernet Network for communication, shall be designed for interoperability with future fleets without requiring configuration or software changes (that are not affected by the defined ETB interface).
 - ii). The vehicle specific definition of faults, alarms, screen and screen layouts, display panels, vehicle status, and vehicle network capabilities shall be transmitted by each vehicle via the ETB. The transmission of these data items shall enable future fleets to be integrated without modification to the vehicle's software. It is anticipated that this will be accomplished utilizing a stack of technologies including service discovery protocols such as zeroconf, application protocols such as HTTP, markup languages such as XML or HTML, and scripting languages such as JavaScript.
 - iii). The technologies utilized shall be non-proprietary and fully defined by the Contractor to enable future fleets to add displays to the monitoring and diagnostic display, as well as allow access to the monitoring, diagnostic, and status information of the vehicle to the displays integrated on future fleets. This shall allow future fleets, including locomotives coach cars, and cab cars, display information on the maintenance display and driver display of the vehicles purchased under this contract without requiring modifications to software installed on this fleet of coach cars.
 - iv). Details of the interoperability shall be submitted with the Network Interface Control Document.
 - v). To facilitate development and integration of current and future fleets into the ETB network, the Contractor shall supply a PC based network simulator software package which provides the capability to simulate ETB and Car Ethernet Network communication.

15.5 480 VAC Head End Power (HEP) Trainline System

- a). General
 - i). HEP will be provided from the source to the trainset through receptacles and jumpers at standard locations on each end of the trainset and on both sides of the coupler, in accordance with APTA Recommended Practice PR-E-RP-016-99.
 - (1) Total should be 4 connectors (two male, two female) on each end of the car able to conduct 1600 Amps combined or 400 Amps each.
 - ii). In addition to the three main power conductors, the HEP cabling shall also include three control wires to provide locomotive trainline complete information (indicating all cabling throughout the train is in place), and a car-to-car carbody ground bond.
 - (1) HEP circuit assignments shall be in accordance with Amtrak Specification 963.

- iii). Load Balancing
 - (1) The loads between phases shall be balanced so that the load on one phase will not exceed more than 5% of the load on either of the other two phases.
 - (2) The delta phase current between any phases shall always remain under 90A total for train lengths of 22 cars to prevent locomotive HEP shutdown faults.
 - (3) Load balancing shall take into account each car type and operational loadings including maximum heating, partial heating, maximum cooling, partial cooling, re-heat and ventilation only modes.
- iv). All HEP cabling shall be arranged and routed to minimize EMI emissions using techniques including trefoil arrangements, shielding, and other strategies.
- b). Receptacles and Jumpers
 - i). Semi-Permanent Jumper Cables
 - (1) Both ends of the trainset shall be equipped with two semi-permanent jumper cables utilizing the latest fabrication techniques and two receptacles with housings, per APTA Recommended Practice PR-E-RP-016-99 and APTA Recommended Practice PR-E-RP-018-99.
 - (2) Components shall be in accordance with Amtrak Specification 223 and Amtrak drawing D-12-7191, and include 480VAC semi-permanent jumpers, 480VAC receptacles, and 480VAC receptacle housing.
 - (3) The HEP jumpers shall be of adequate length to reach from the end sheet to the trainline junction box.
 - (4) No portion of the HEP cables shall hang down to within 5 in. of the top of rail (vertically) when connected to an adjacent car on straight, level track.
 - (5) No portion of the cable shall pass below top of rail when navigating a 250 ft. radius turn.
 - (6) Each semi-permanent jumper shall be replaceable in under 30 minutes.
 - ii). HEP Receptacles
 - (1) The receptacles shall be mounted with a downward slope of approximately 15° to provide drainage.
 - (2) Receptacles and fixed jumper flanges shall be mounted to the carbody with stainless steel bolts.

- (3) All HEP receptacles shall be labeled with appropriate danger 480V warnings, in accordance with Amtrak Specification 696.
- (4) Receptacle Mounting Plate
 - (a) The plate to which the receptacles and fixed jumper flanges are mounted shall be reinforced to resist, without bending, a 500 lb. force produced from pulling the locked jumper out of the receptacle, such as by an unintended uncoupling.
 - (b) They shall consist of a short length of stainless steel tubing with a stainless steel crossbar at the bottom, of a diameter to accept the 480V plug body, yet prevent it from sliding through.
 - (c) The holster shall be sloped steeply downward to allow any moisture which has accumulated in the plug to drain.
- iii). HEP Trainline Junction Box
 - (1) The trainline junction box shall be located at the transition bulkhead or if there is no transition bulkhead, beyond the adjacent truck.
 - (2) This shall be accomplished without requiring connectors, splices or intermediate terminals.
- c). Wiring and Connections
 - i). The 3-phase HEP trainline power cables per APTA Recommended Practices PR-E-RP-002-98 and PR-E-RP-009-98, with 1600 amp capacity, shall be routed along the length of the trainset.
 - ii). The wire used in the trainline power cables shall be 4/0 as specified in APTA Recommended Practice PR-E-RP-016-99.
 - iii). The voltage drop due to the impedance of the power trainline at the extreme end of the trainset shall be minimized under the train's heaviest load.
 - iv). The Contractor shall supply a line voltage analysis showing the voltage loss from one end of a trainset to the opposite end under the heaviest load case. **[CDRL 15-03]**
 - v). The HEP cables may run between junction boxes of each car in a protected wire race depending upon the trainset design.
 - vi). All cables shall be enclosed in rigid galvanized steel conduit or trays, where possible, and shall be supported by heavy duty stainless steel conduit straps equipped with vibration resistant material at intervals not to exceed 48 in.
 - vii). All cables not able to be installed in rigid galvanized steel conduit shall be protected from debris strikes and will be supported by suitable cleats at appropriate intervals not exceeding 24 in.
 - viii). Spare COMM and MU trainline wires shall be identified in the junction boxes.

- d). Power Junction Boxes
 - i). An HEP trainline junction box shall be located at each end of the cars, where the jumpers and leads from the receptacles on the end sheet shall be terminated and connected to the trainline cables running the length of the trainset. Power junction boxes may also be located on the individual car bulkheads. This arrangement may be different depending upon trainset configuration and shall be approved by Amtrak.
- e). End of Train Short Loop
 - i). There shall be physical switches that can quickly configure a car as a non-end car, or an end car. These switches shall be located inside the electric locker and have provisions to attach switch seals.
 - ii). When the switch(es) are in "Pass-thru" position, all of the HEP power trainlines shall pass through to the HEP jumpers or receptacles.
 - iii). When the switch(es) are in "Short-Loop" position, all of the HEP power trainlines shall be short-looped without the need for external jumper cables.
 - iv). Short looping HEP jumper cables shall be allowed as an emergency option in case there is a failure with the End-of-Train switch functionality.
- f). Emergency 480VAC Backup Operation (OPTION)
 - i). In the event of a locomotive 480VAC HEP failure, there shall be an emergency backup power system capable of supply 480VAC power for the following systems:
 - (1) HVAC System, operating at reduced capacity. See Section 10.08.I) for additional information.
 - (2) Water and Waste System, operating at reduced capacity. See Chapter 17 for additional information.
 - (3) LVPS System, operating in load shed mode. See Table 15-1 for additional information.
 - ii). The emergency backup power system must include all necessary controls, switch gear, interfaces and sensors to:
 - (1) Coordinate an automatic changeover from locomotive sourced HEP to emergency power.
 - (2) Provide full protection for the emergency backup power system from overload, supply overvoltage, and all transient events.
 - (3) Provide full protection for all connected loads from any failures or maloperation of the emergency power supply.

- iii). The emergency backup power supply converter shall be designed and tested per IEC 61287, and all other requirements for power converters as detailed elsewhere in these technical specifications.
- iv). The emergency backup power supply system shall include a diagnostic interface to the car diagnostic system. See Chapter 24 for additional information.
- v). The emergency backup power system shall output a hardwire signal that will provide the signal for the emergency load systems to enter Emergency Operation Mode. The hardwire signal shall be monitored by the car diagnostic system.
- vi). Four separate options shall be prepared to provide reserve capacity for a period of 4 hours, 8 hours, 24 hours, and 48 hours.
- vii). Details for the proposed emergency backup power supply system shall be submitted for review and approval [**CDRL 15-04**]

15.6 480VAC Power Distribution

a). General

- i). The 480VAC power is distributed within the cars utilizing switch and circuit breaker panels located in the electrical and/or equipment lockers.
- ii). 480 VAC power shall be controlled and fed to all loads through this distribution system.
- iii). Each 480VAC circuit breaker auxiliary contact shall be monitored by the diagnostic system.

b). Main HEP Circuit Breaker

- i). One main circuit breaker shall be provided in the electrical locker to allow isolation of each car from the 480VAC trainline systems.
- ii). The main 480VAC circuit breaker auxiliary contact shall be monitored by the diagnostic system by a dedicated I/O.

c). Power Transformers

- i). All transformers shall be of a dry type, convection cooled, and in accordance with Amtrak Drawing D-65-7449, revision D, unless otherwise approved.
- ii). All transformers shall have delta primary windings.
- iii). All inputs and outputs shall be circuit breaker protected with suitable circuit breaker discrimination to avoid unnecessary loss of equipment functionality under load fault conditions.
- iv). At a minimum, the following types of transformers shall be provided at a minimum on all car types:

- (1) 480/120VAC transformers to provide 120VAC service with GFCI functionality.
 - (2) 3-phase 480/208-120VAC, delta-wye, to provide 120-208VAC, 3-phase service with a grounded neutral.
- v). If the contractor can demonstrate that the 120VAC service, with acceptably stable voltage, with GFCI functionality may be provided from a tertiary winding from the 3-phase transformer, then the contractor may propose this arrangement at preliminary design review.
 - vi). Additional provisions shall be made for food service cars.
 - vii). All transformers shall be located inside the electrical lockers or under car in equipment boxes if necessary.
 - (1) If under the car, transformers shall be sealed to NEMA 4 unless it is located in an IP56 water sealed container.
 - viii). The Contractor shall demonstrate, by calculation, that there is sufficient ventilation to prevent transformer failure and/or damage resulting from excessive heat buildup during all operating conditions.
 - ix). Transformers shall be derated at least 10% for current, or other appropriate approved factor, based upon duty cycle.
 - x). Transformers shall be thermally rated such that their life expectancy shall exceed that of the vehicles when operated at full load and at specified maximum ambient temperatures.
 - xi). Maximum ambient temperatures shall include in the analysis increases in temperature above vehicle external ambient temperature in the transformer mounting locations, transformer efficiency losses, and heat generated from other equipment adjacent to the transformers.
 - xii). Calculations shall be provided to demonstrate that the transformers provided have sufficient capacity to supply their intended loads with 15% capacity reserved for future use and will have an expected lifetime exceeding that of the vehicle. **[CDRL 15-05]**

15.7 120VAC Power Distribution

- a). General
 - i). The 120VAC power shall be distributed within the car utilizing 480/120VAC step down transformers, and switch and circuit breaker panels located in the electrical equipment lockers.
 - (1) Power shall be controlled and fed to all 120VAC loads through this system.
 - ii). A main circuit breaker shall control the power distribution to all 120VAC circuit breakers.

- iii). The main 120VAC circuit breaker auxiliary contact shall be monitored by the diagnostic system by a dedicated I/O.
 - iv). Weather-proof, GFCI protected service outlets shall be provided undercar near subcomponent assemblies spaced no less than 25' from any major system and isolated on a separate circuit independent of interior outlets.
 - v). Each 120VAC circuit breaker auxiliary contact shall be monitored by the diagnostic system.
 - vi). Passenger convenience outlets on bi-level cars shall be divided into a minimum of twelve (12) separate circuits.
- b). Passenger Convenience Outlets
- i). Passenger Seat Outlets
 - (1) A flush-style 120VAC duplex convenience outlet shall be installed in each revenue seat location using the GFCI circuits, as detailed in Chapter 11, and shall include an equal number of appropriate USB ports as approved by Amtrak.
 - (2) Provisions shall be included so that outlets do not limit the ability to reconfigure seats within the cars.
 - (3) The outlets are intended to provide power for passenger electronic equipment, such as laptop computers.
 - ii). Table Outlets
 - (1) Two duplex outlets supplied by a power strip, shall be installed at each table, located such that the table or seat does not interfere with access to the outlet.
 - (2) Each outlet shall also include an equal number of USB ports.
 - iii). An Amtrak-standard 120V decal per Amtrak Specification 697 shall be installed at each outlet location.
 - iv). The passenger convenience outlets shall be protected by a number of separate power circuits, each of which shall be equipped with a 20 amp GFCI breaker with test and reset buttons.
 - (1) The convenience outlets on each car shall be evenly divided into the power circuits.
 - (2) The number of power circuits will be determined by the Contractor, but they should use 1 amp per foot of carbody as a guide.
 - v). Each passenger convenience outlet shall include a power indicator light to indicate power at the outlet.

- c). Interior Service Outlets
 - i). Duplex GFCI service outlets shall be located in each toilet room, electrical locker and utility lockers in all car types, in locations and quantities suitable for their intended use in those areas.
 - ii). The food service area of the food service car shall be equipped with GFCI protected service outlets as specified in Chapter 16.
 - iii). Service outlets shall be protected locally by GFCI outlet rated for 120VAC, single phase, 60 Hz, 20 amps at each service outlet location.
- d). Special Service Outlets
 - i). In each accessible area, luggage rack tower, and bicycle rack area, there shall be a dedicated GFCI outlet or charging cable capable of charging mobility aid devices such as electric wheelchairs.
 - (1) The circuit shall be fed by a dedicated circuit breaker and all associated wiring shall be able to support up to 30A current draw.
 - (2) If the outlet itself cannot support 30A, the circuit breaker shall be rated to the weakest component in the arrangement.
 - ii). In each bicycle rack area, there shall be GFCI outlets capable of charging electric bicycles and scooters.
 - (1) There shall be sufficient outlets to plug in each bicycle that can be stored in the area.
 - (2) The circuit shall be fed by a dedicated circuit breaker and all associated wiring shall be able to support up to 20A current draw.
- e). Sleeper Room Service Outlets
 - i). Each sleeper room shall have 120VAC duplex convenience outlets with GFCI protection and shall include an equal number of appropriate USB ports as approved by Amtrak. See Chapter 11 for more information.
 - ii). A fault event in any sleeper room shall not impact any other sleeper room on the car.

15.8 Battery Charger

- a). General
 - i). Each car within the trainset shall have two solid-state DC battery chargers with temperature compensation.
 - (1) The second battery charger will act as an emergency hot standby in case the first battery charger has a failure and can no longer operate. If the first battery charger fails, the changeover to the second battery charger shall be automatic and not require any manual intervention.

- (2) Battery chargers shall rotate to avoid extended periods of inactivity.
 - (3) There shall be a backup manual override that can be crew operated in case the automatic battery charger changeover fails.
 - (4) Each individual battery charger shall meet the reliability requirements in Chapter 4.
 - (5) The battery charger shall be either mounted under the car in an equipment box, near the battery box, oriented so that the indicator lights can be seen from outside the car without opening panels, or the battery charger shall be installed in the electrical locker.
 - (6) The battery charger shall be rated appropriately for the DC load it will be supplying.
 - (7) Alternative proposals, subject to Amtrak review, may be allowed if the performance criteria is satisfactorily accounted for.
 - (8) The battery charger function description shall be submitted at PDR and updated during design review. **[CDRL 15-06]**
- ii). The battery charger shall provide DC power to support all DC loads, including battery charging, while the car is operating with HEP on.
 - iii). Upon the loss of HEP or the failure of the battery charger, the system shall automatically transfer the DC loads to the battery system without interruption of power and shall be demonstrated during design review.
 - iv). The DC battery system shall be responsible for feeding car loads and systems which must be available for operation independent of the availability of the 480VAC HEP, such as public address, digital trainline, marker lights, side and end door systems, standby lighting, cab functions, and others, as specified in Table .
 - v). The battery and charger system shall be comprised of:
 - (1) Battery charger with temperature sensor
 - (2) Battery (multiple cells)
 - (3) Load drop device or devices
 - (4) Load drop controller (may be located elsewhere)
 - (5) The same battery type and battery charger shall be used everywhere on the trainset.
- b). Operation
- i). The battery charger shall be connected in parallel to simultaneously charge the battery while supplying power to the individual car bus and shall be

capable of supplying uninterrupted DC power during load transfer between LVPS and battery.

- ii). The charging system shall incorporate modes for Current Limit, Normal Charge, and Trickle Charge.
 - iii). The Contractor shall propose an Amtrak approved method to incorporate battery charging and the output voltage will be regulated at a battery temperature-compensated value.
 - iv). The charger shall be sized with sufficient capacity to simultaneously recharge the battery from a fully discharged state and to support the maximum possible DC bus loads plus a 25% reserve beyond the worst-case continuous load condition.
 - v). Recharge time of a fully discharged battery shall not exceed five hours to reach at least 80% of capacity at 77°F, with all normal car DC loads on.
 - vi). The Contractor shall provide, at design review, a load budget assessment that includes calculations to demonstrate that the charger provided has sufficient capacity to meet these needs. **[CDRL 15-07]**
- c). Basic Charger Characteristics
- i). Basic charger characteristics shall include the following:

Input Voltage	480VAC nominal (tolerance range +10%/-15%), 3-phase, 3-wire
Input Frequency	60 Hz nominal (tolerance range 56-64 Hz)
Input Protection	3-pole circuit breaker (external reset)
Output Voltage, Temperature Compensated	73.6VDC at 68°F ambient; 80VDC maximum
Temperature Compensation	In accordance with the battery manufacturer's recommendation
Ripple	Maximum of 2 volts peak-to-peak any load within rating
Audible Noise	62 dBA maximum for components mounted inside the car
Ability to automatically recharge the battery from any state of discharge, including 0 volts on battery terminals.	

Charging voltage ambient temperature compensated as sensed at the battery.
Following a HEP power outage, the charger shall restart with a reduced current load for a period of time after restoration of HEP in order to minimize the short-term startup HEP load.
Diagnostic information for the battery charger and battery current and voltage levels shall be recorded and available remotely through the CCU.
See Chapter 4 Reliability, Availability, Maintainability for additional requirements.

d). Circuit Breakers

- i). The charger system shall be equipped with two circuit breakers, one for the charger output and one for the battery disconnect near the battery charger.
- ii). If needed a second battery disconnect switch shall be located adjacent to the battery box.

e). Indicators

- i). The charger shall include individual status indication LEDs that are displayed from the front face. These shall include:

Supply 480VAC On	Green
Current Limit (in current limit mode)	Amber
Load Dump Relay Energized	Amber
Supply 480VAC off/out of tolerance	Red
Rectifier Failure	Red
Temperature Sensor Failure	Red

- ii). A lamp test pushbutton shall be provided, which when pressed will cause all lamps to light. All indicators and meters should be able to operate without 480VAC present.
- iii). The charger shall include four meters on the front face:

DC Amps (total charger output)	0-100 amps
Battery Amps (current into/out of battery)	100-0-100 amps (zero center)

DC volts (charger output voltage)	0-100 volts
Battery Temperature	0-250 degrees F

- iv). All metered information, diagnostics, and fault information shall be recorded and available remotely through the car diagnostic system.
- f). Self-Protection
 - i). At a minimum, the charger shall be self-protected against the following fault conditions:
 - (1) Open circuit battery or wiring
 - (2) Short circuit battery or wiring
 - (3) Battery ground fault
 - (4) Temperature sensor fault
 - (5) Low input voltage
 - (6) Low output voltage.
 - (7) Input phase loss
 - (8) Reversed battery connections
 - (9) System overload
 - (10) Voltage or current over limit
 - g). Temperature Sensor
 - i). The temperature sensor shall be sealed and mounted onto one of the inter-cell plates of the battery assembly and shall be sufficiently marked so as to be readily identifiable and accessible during maintenance or battery cell change out.
 - h). Operation of Battery Charger System
 - i). Operation of the battery charger shall be as follows. See Table 15-3 for additional details:
 - (1) **Normal Mode:** 480VAC HEP "ON"; DC system "ON"
 - (a) All AC and DC loads available
 - (b) All DC loads fed by battery charger
 - (2) **Standby Mode:** 480VAC HEP "OFF"; DC system "ON"

- (a) Battery voltage above manufacturer recommended standby level based on battery type.
 - (b) All DC loads fed by battery
 - (c) Immediately after loss of HEP, the car shall go into standby mode, where most of the car lighting, all doors, ECP braking, and the communications system remain in operation.
 - (d) Refrigeration equipment shall remain on.
- (3) **Load Shed Mode:** 480VAC HEP “OFF”; DC system “ON”
- (a) Battery voltage potential range for load shed the manufacturer has recommended based on battery type.
 - (b) Only essential DC loads remain on, de-energizing non-essential systems.
- (4) **Emergency Mode:** 480VAC HEP “OFF”; DC system “OFF”
- (a) Battery voltage below the manufacturer recommended minimum level based on battery type.
 - (b) All DC loads are without power because the load drop device has disconnected the battery system or the battery system is disabled due to equipment failure.
 - (c) In emergency mode only independently powered systems remain on. Upon restoration of HEP, all DC loads shall be available immediately after a brief window to confirm HEP is stable, including those that were disconnected as part of standby, emergency or load drop. DC load transfer by the battery charger shall be independent of the state of the battery when HEP is available. The battery charger should be able to operate normally regardless of the condition of the battery set.
- i). Load Shed/Drop Device
- i). The low-voltage power system shall be equipped with a switching device(s), which shall shed load from the battery in accordance with 15.7.7 and the battery manufacturers recommendations.

15.9 Battery System

- a). General
 - i). The battery shall provide power for necessary systems when the HEP system is not available.
 - ii). The battery system shall be compliant with APTA Recommended Practice PR-E-RP-007-098.

b). Batteries

- i). The Contractor shall submit a battery design that:
 - (1) Meets the load requirements found in Table with at least 25% extra capacity;
 - (2) Provides the longest life-cycle cost effective system; and
 - (3) Provides the latest technology that is available in passenger rail battery design.
- ii). All car types shall utilize the same type of battery cell.
- iii). The batteries shall be recharged by the battery charger as specified above.
- iv). Batteries shall be nickel-cadmium (Ni-CAD), lithium ion or nickel-metal hydride, or other Amtrak approved type.
 - (1) Lead-acid batteries are prohibited.
- v). The batteries shall be housed in cases of a fire-retardant design.
- vi). The batteries shall be a low-maintenance type and shall not require the frequent adjustment of the electrolyte level.
- vii). The battery system may utilize a centralized water fill apparatus that meets the ambient environmental requirements of the specification.
- viii). The battery shall be designed to minimize hazards to operating personnel during service, operation, line maintenance and shop maintenance.

c). Battery Performance

- i). Nominal battery voltage of 64VDC shall be provided to the DC power distribution system in each car when HEP is not present and the batteries are fully charged.
 - (1) Alternate methods of compliance for battery system voltage may be proposed but must still meet the requirements and relative performance characteristics and modes specified for the battery and battery charger systems.
- ii). The batteries shall have a design service life of no less than twelve years and shall be capable of withstanding a minimum of 2000 deep cycles without failure.
 - (1) A deep cycle shall be defined as discharging the battery to 0.8V/cell to 1.0V/cell and recharging it to 80% of its rated capacity at 77°F in no more than five hours.
 - (2) The actual discharge voltage will be established in accordance with the battery manufacturer's recommendations.

- iii). The battery system shall be sized to carry the full DC load after loss of HEP, as defined in Table (standby mode) for no less than two hours.
 - (1) The battery system shall provide a 25% power safety margin above the calculated load.
 - iv). A DC load budget shall be developed by the Contractor and submitted to Amtrak for approval during the design review process, demonstrating that the battery system as proposed meets all requirements and provides adequate capacity for the required loads for the required duration.
- d). Battery Markings
- i). Each battery cell or battery unit shall be permanently marked with the following information:
 - (1) Manufacturer's name
 - (2) Battery type
 - (3) Catalog or part number
 - (4) Nominal rated capacity at five- and eight-hour discharge rates
 - (5) Serial number
 - (6) Date manufactured
 - (7) Amtrak name
 - (8) Amtrak part number
 - (9) Warning and safety precautions (i.e. use no acid, etc.)
 - (10) Blank space where installation date can be written
 - ii). Markings shall be resistant to the chemical and mechanical environment encountered in service for the design life of the cell.
 - iii). Polarity of the positive cell terminal shall be identified by a red post insulator or bushing and/or a plainly marked p, pos or + symbol.
 - iv). Polarity of the negative post shall be identified with a black post insulator or bushing and/or a plainly marked n, neg or - symbol.
- e). Battery Enclosure
- i). Design and Construction
 - (1) Battery Enclosures shall meet the requirements of 49 CFR 238.225 and EN 50272-2.

- (2) The batteries shall be housed in an approved rattle-proof stainless steel battery box located in an approved location under the car floor unless isolated from the passenger seating areas by a non-combustible barrier.
 - (3) The battery box shall be of adequate size to accommodate a crated battery from at least two suppliers.
 - (4) Battery enclosure covers shall be hinged and designed to prevent the direct entry of water.
 - (5) No combustible material shall be used for the trays or cell blocking.
 - (6) The battery box floor shall have a drain inboard of the running rail.
 - (7) Means shall be provided to prevent lateral and longitudinal movements of the battery using approved fire resistant material.
 - (8) The cells shall be installed such that the plates are parallel to the sides of the car.
 - (9) Wire terminations shall be both labeled and color coded red (for positive) and black (for negative).
- ii). Accessibility for Maintenance
- (1) The battery shall be mounted for ease of replacement and maintenance.
 - (a) All cells shall be fully and easily accessible for servicing.
 - (2) When open, the hinged covers should provide unimpeded access to the batteries for the replacement or routine maintenance and shall include a suitable prop rod or latching mechanism to hold the access door open.
 - (3) If the battery trays must be moved to provide access for servicing, they shall be mounted on a robust locking slide-out tray.
 - (a) The tray shall lock in the fully extended and fully retracted positions, with a safety latch.
 - (b) Sufficient slack shall be provided in the battery cables to permit tray movement, and anti-chafing materials such as cable carriers shall be applied to prevent damage to the cables.
 - (c) Use of cable disconnect plugs for tray movement is prohibited.
 - (4) The rearmost cells shall have vertical line of sight visibility to the filler caps well clear of the side of the carbody when the tray is extended.
 - (5) The battery box shall be completely self-draining to allow flushing of the battery with water.

- iii). Ventilation
 - (1) Battery venting shall be designed so that there can be no accumulation of trapped gases.
 - (2) There shall be no devices that can cause sparking in the battery ventilation airflow.
 - (3) Ventilation holes shall be provided with a fine mesh that allows for proper ventilation but prevents intrusion of leaves or small debris.
 - (4) Fiberglass or other approved fire resistant easily replaceable filtering media shall be applied to ventilation openings to prevent dust ingress due to car motion.
- f). Battery Disconnect
 - i). There shall be a battery disconnect available to first responders in case of an accident. The location shall be readily accessible in any accident scenario include a rollover derailment such as in the interior in the vestibule area.
 - ii). The battery disconnect concept and arrangement shall be submitted at Preliminary Design Review. **[CDRL 15-08]**

15.10 DC Power Distribution System

- a). General
 - i). Power for all DC loads shall be distributed throughout the car through switch and circuit breaker panels located in the electrical equipment lockers.
 - ii). A master battery emergency OFF switch/pushbutton shall be included in the switch locker, which shall permit the train crew to totally disconnect the car battery from all car loads.
 - iii). Each DC branch return circuit shall be floated from the carbody.
 - iv). The low voltage power distribution arrangement concept shall be submitted at Preliminary Design Review. **[CDRL 15-09]**
- b). 74VDC Power System
 - i). Systems and components that are operated on 74VDC shall be powered from the battery charger through a power distribution system that includes control switches, circuit breakers and load shed and load drop relays located in the electrical locker.
 - ii). Circuit breakers shall be sized and labeled according to their circuit and function.
 - iii). A main circuit breaker shall control power distribution to all 74VDC circuit breakers.

- iv). The main 74VDC circuit breaker auxiliary contact shall be monitored by the diagnostic system by a dedicated I/O.
- v). Each 74VDC circuit breaker auxiliary contact shall be monitored by the diagnostic system.
- c). 24/12VDC Power System
 - i). If multiple systems utilize 24VDC or 12VDC power sources, then there shall be a consolidated 24/12VDC power distribution system located in the electric locker instead of using multiple DC/DC converters.
 - ii). A main circuit breaker will be supplied for the DC-to-DC converter and each sub system utilizing the 24/12VDC system shall have its own dedicated circuit breaker.
 - iii). Each converter shall report health to the diagnostic system.
 - iv). Each 24/12VDC circuit breaker auxiliary contact shall be monitored by the diagnostic system.
- d). DC-to-DC Converters and Inverters
 - i). DC-to-DC Converters and Inverters used to supply other voltages, including commercially available units, shall be certified to EN 50121 and 50155.
 - ii). Converter and Inverter reliability shall meet the auxiliary power MDBC requirements in Chapter 4.

15.11 Electrical Panels

- a). General
 - i). An electrical locker shall be provided in all car types, locked with the standard coach key.
 - (1) All control switches, circuit breakers and indicators shall be located in this locker unless specified otherwise.
 - ii). Controls and switches designated for crew operation shall be located on electrical panels separate from devices designated for maintenance operation such as circuit breakers.
 - (1) If crew and maintainer controls are located in the same locker, the panels shall have separate doors to prevent crew operators from accidentally using maintenance devices.
 - iii). All circuit breaker and switch panels shall meet all recommendations of APTA Recommended Practice PR-E-RP-002-98.
 - iv). The circuit breaker panels shall be dead front type, with removable front covers, of a design such that all components are front serviceable.

- v). Circuit breakers shall be arranged so that the handles move vertically, with the ON position up.
 - vi). The panels shall be conveniently located, in the electrical locker, for ease of access by service personnel.
 - vii). Reduced wiring and ease of maintenance shall be of prime consideration.
 - viii). If it is impractical to house all circuit breakers in the electrical locker, additional circuit breaker panels may be proposed for Amtrak approval.
 - ix). A wiring gutter shall be provided along the top, sides and bottom, for the routing of high voltage leads to their designated circuit breakers.
 - x). Appropriate installation methods and materials (wire gutters, conduits, tie bars, etc.) shall be provided for routing high voltage leads to their designated circuit breakers internal to the electrical locker.
 - xi). The circuit breaker panel shall be configured for easy removal so that maintenance and repair action are not impeded.
 - xii). Electrical locker arrangement, including separation details of crew operated devices and maintenance operated devices, shall be submitted at IDR.
[CDRL 15-10]
- b). Switch and Circuit Breaker Panel Arrangement
- i). Each circuit breaker panel shall carry apparatus arranged to be easily accessible to connections and designed to prevent an operator from coming in contact with live voltage when operating switches or circuit breakers.
 - ii). All switches and circuit breakers shall be provided with a nameplate clearly identifying the electrical circuit it controls with at least three spare slots for future circuit breaker installations.
 - iii). The ampere rating for each circuit breaker shall be indicated on the circuit breaker front plate, arm or toggle lever.
 - iv). All circuit breakers and switches shall indicate ON with toggle up and OFF with toggle down.
 - v). Circuit breakers for the different voltage power distribution systems shall each be grouped with their respective voltage and be labeled according to the appropriate voltage.
 - vi). A main circuit breaker shall be provided for each voltage level.
 - vii). Circuit breakers, whether in groups or individually, shall provide a means for locking out and tagging out.
 - viii). The Contractor shall illustrate the Lock Out Tag Out procedure during the design review process.

15.12 Spare Conduit

- a). Spare conduits shall be installed for future use in concealed areas where there are no access panels. Spare conduits shall follow requirements in APTA PR-E-RP-002-98, Installation of Wire and Cable.
- b). Areas include but are not limited to underneath the floor panels, sidewalls, vestibules, ceiling panels, etc. for running future wiring laterally across the aisle, or longitudinally down the car.
- c). Spare conduits shall be uninterrupted from end to end. If pull boxes are needed, they shall be located in areas that have sufficient maintenance access.
- d). Spare conduit size shall be a minimum 0.5 in.
- e). Spare conduit shall have a pre-installed spare wire through the length of the conduit to facilitate easy wire pulling in the future. The spare wire shall be an appropriately size that can withstand the mechanical strength of pulling a bundle of wire without breaking.
- f). There shall be separate spare conduits for 208V class, 120V class, 74V class, and communications and network class wiring.
- g). From the 120V circuit breaker panel, there shall be conduits that can run wire to each corner of the car.
- h). From the 74V circuit breaker panel, there shall be conduits that can run wire to each corner of the car.
- i). For communications and network conduits, there shall be sufficient conduits between equipment lockers and vacant areas where future equipment could be installed.

15.13 Car Location Identifiers for All Subsystems

- a). To consolidate LRU configurations, each LRU that can be installed in multiple locations within the car shall utilize a car location identifier key integrated into the car wiring.
- b). Each LRU shall be able to read the location and determine on its own the appropriate functionality.
- c). LRUs shall not be manually configured with different software, dip switch settings, or other manual means.
- d). The system integrator shall be responsible to oversee that each subsystem is following this approach.

15.14 Integrated Schematics

- a). The Contractor shall prepare and submit, for acceptance by Amtrak, an integrated schematic diagram package showing all electrical systems and including all components, wiring, and loads on the car. **[CDRL 15-11]**

b). Conduit, wiring, and locator diagrams should also be included. See Chapter 23.

Table 5-1: Communication Trainline Pin Assignments

(For end of trainset car-to-loco connections only. Intercar connections may be different)

Pin	Amtrak Standard	APTA Standard
1	Shield	Shield (Common)
2	Battery Negative	Battery Negative
3	PA/Tape Music #1 (black) (**)	PA/Tape Music #1 (black)
4	PA/Tape Music #1 (white) (**)	PA/Tape Music #1 (white)
5	Intercom (black) (**)	Intercom (black)
6	Intercom (white) (**)	Intercom (white)
7	PA Control (black) (**)	PA Control (black)
8	PA Control (white) (**)	PA Control (white)
9	Passenger Info (black) (**)	Music-3 (radio)(black)
10	Passenger Info (white) (**)	Music-3 (radio)(white)
11	Brake Application (pass-thru for future use)	Brake Application
12	Brake Release (pass-thru for future use)	Brake Release
13	Brake Negative (pass-thru for future use)	Brake Negative
14	Open Doors R.H. (*)	Open Doors R.H.
15	Open Doors L.H. (*)	Open Doors L.H.
16	Close Doors R.H. (*)	Close Doors R.H.
17	Close Doors L.H. (*)	Close Doors L.H.
18	Door Closed Light (*)	Door Closed Light
19	Brake Released Light	Brake Released Light
20	Brake Applied Light	Brake Applied Light
21	Hot Journal Light	Hot Journal Light
22	Conductor's Signal	Conductor's Signal
23	Door Closed Light (*)	Door Close Light
24	Tape Music #2 (black) (pass-thru)	Tape Music #2 (black)
25	Tape Music #2 (white) (pass-thru)	Tape Music #2 (white)
26	Conductor's Door Light Feed	Conductor's Door Light Feed
27	Attendant Call System	Attendant Call
Crossed Trainlines (*)	14 & 15, 16 & 17, 18 & 23	14 & 15, 16 & 17, 18 & 23
Twisted Shielded pairs (**)	3 & 4, 5 & 6, 7 & 8, 9 & 10, 24 & 25	3 & 4, 5 & 6, 7 & 8, 9 & 10, 24 & 25
Source	Amtrak dwg A-63-7676-1 (under revision)	APTA Std PR-E-RP-017-99

Table 155-2: Multiple Unit (MU) Trainline Pin Assignments

All MU trainlines shall be pass-thru with no interruptions as described in 15.3.2

Pin	Amtrak Standard	APTA Standard
1	Reserved Pass-thru	Spare (reserved for cruise control)
2	Alarm Bell	Alarm Bell
3	D Throttle	D Throttle
4	Control Negative	Control Negative
5	Emergency Sand	Emergency Sand
6	Generator Field	Generator Field
7	C Throttle	C Throttle
8	Forward (*)	Forward (*)
9	Reverse (*)	Reverse (*)
10	Wheel Slip	Wheel Slip
11	Reserved Pass-thru	Spare
12	B Throttle	B Throttle
13	Control Positive	Control Positive
14	Reserved Pass-thru	Spare
15	A Throttle	A Throttle
16	Engine Run	Engine Run
17	Dynamic Brake Setup	Dynamic Brake Setup
18	Remote Loadmeter (**)	Remote Loadmeter (**)
19	Remote Loadmeter (**)	Remote Loadmeter (**)
20	Dynamic Brake Warning	Dynamic Brake Warning
21	Dynamic Brake Start	Dynamic Brake Start
22	Reserved Pass-thru	Spare
23	Manual Sanding	Manual Sanding
24	Dynamic Brake Excitation	Dynamic Brake Excitation
25	Reserved Pass-thru	MU Headlight
26	Remote Fault Reset	Remote Fault Reset
27	Brake Emergency	Brake Emergency
Crossed Trainlines (*)	8 & 9	8 & 9
Twisted Shielded pairs (**)	18 & 19	18 & 19
Source	Amtrak dwg A-63-7676-1 (under revision)	APTA Std PR-E-RP-017-99

Table 153: Power Phase Matrix

NOTE: Battery voltage levels listed are included as an example based on specific battery type / chemistry.

Condition	Normal	Standby	Load Shed	Emergency
Description of Condition	<ul style="list-style-type: none"> - HEP Power. Normal operation. - All systems on and functioning. 	<ul style="list-style-type: none"> - After loss of HEP. Systems powered by main car batteries. - ALL DC loads on. 	<ul style="list-style-type: none"> - After standby. Essential systems powered by main car batteries. 	<ul style="list-style-type: none"> - No car battery power. Lights are independently powered per FRA requirement.
Timeline	normal	2 hours		90 minutes
Threshold	normal	after HEP loss	after standby	after load shed
DC Lights:				
All Passenger Interior Lights. Vestibules, Toilet Rooms, Electric Locker, Sleeper Rooms, Kitchen Reading	Yes	Yes	Yes	No
All Exterior Lights: Platform, Status, Marker Lights	Yes	Yes	Yes	No
Independent Power Source Emergency Lights	No	No	No	Yes
Doors:				
Side Door Controls and Operators	Yes	Yes 40 sec every 30 min	Yes 40 sec every 30 min	No
End Door Controls and Operators	Yes	Yes 30 sec every 5 min	Yes 30 sec every 5 min	No
Door Closed Summary Circuit	Yes	Yes	Yes	No
Communications and Networks:				
PA	Yes	Yes 20 sec every 20 min	Yes 20 sec every 20 min	No
Networks	Yes	Yes	Yes	No

CONFIDENTIAL — DO NOT DISTRIBUTE

Condition	Normal	Standby	Load Shed	Emergency
Description of Condition	<ul style="list-style-type: none"> - HEP Power. Normal operation. - All systems on and functioning. 	<ul style="list-style-type: none"> - After loss of HEP. Systems powered by main car batteries. - ALL DC loads on. 	<ul style="list-style-type: none"> - After standby. Essential systems powered by main car batteries. 	<ul style="list-style-type: none"> - No car battery power. - Lights are independently powered per FRA requirement.
Timeline	normal	2 hours		90 minutes
Threshold	normal	after HEP loss	after standby	after load shed
Communications	Yes	Yes	Yes	No
Passenger Wi-Fi	Yes	Yes	No	No
HVAC System:				
HVAC heating and cooling	Yes	No	No	No
HVAC Emergency Operation OPTION**	Yes	Yes**	Yes**	No
Toilet System:				
Toilet System Emergency Operation OPTION**	Yes	Yes*	No	No
	Yes	Yes**	Yes**	No
Other Systems:				
Wheelslide	Yes	Yes	Yes	No
Elevator Control Panel	Yes	Yes	Yes	No
Onboard Lift Control Panel	Yes	Yes	No	No
Convenience Outlets	Yes	No	No	No
Food Service Cars:				
Refrigeration	Yes	Yes	No	No
Water System	Yes	Yes	No	No
Other Appliances	Yes	No	No	No
Point of Sale System	Yes	Yes	No	No

*Toilet System shall remain functional as long as main car battery, air supply, and water temperature are not preventing safe operation. See Chapter 10 HVAC and Chapter 17 Water and Waste for additional details.

**OPTION if Emergency 480VAC Backup Operation is exercised.

15.15 CDRLs

CDRL	Description	Due
CDRL 15-01	Inter-car connection components	30 days prior to Electrical PDR
CDRL 15-02	Network interface control document	30 days prior to Electrical PDR
CDRL 15-03	Line voltage analysis (Voltage Drop)	30 days prior to Electrical PDR
CDRL 15-04	Emergency Backup system details (OPTION)	30 days prior to Electrical PDR
CDRL 15-05	Transformer capacity and lifespan analysis	30 days prior to Electrical PDR
CDRL 15-06	Battery Charger Function description	30 days prior to Electrical PDR
CDRL 15-07	Battery Charger Load budget assessment	30 days prior to Electrical PDR
CDRL 15-08	Battery disconnect concept and arrangement	30 days prior to Electrical PDR
CDRL 15-09	Low voltage power distribution arrangement concept	30 days prior to Electrical PDR
CDRL 15-10	Electrical locker arrangement, including separation details of crew operated devices and maintenance operated devices.	30 days prior to Electrical IDR
CDRL 15-11	Integrated schematic diagram package	30 days prior to Electrical IDR

* End of Section 15 *

Amtrak Long Distance Bi-Level Fleet Replacement

Technical Specification

16. Food Service

Revision 1

Table of Contents

16.1	Overview	16-1
16.2	General Requirements	16-1
16.3	Material Preferences	16-7
16.4	Kitchen Requirements	16-7
16.5	Servery.....	16-41
16.6	First Class Lounge Bar	16-64
16.7	Café	16-84
16.8	Reference Information	16-105
16.9	CDRLs.....	16-106

Table of Figures

Figure 16-1:	Kitchen Layout - Top View	16-9
Figure 16-2:	Kitchen Layout - Elevation View 1	16-9
Figure 16-3:	Kitchen Layout - Elevation View 2.....	16-9
Figure 16-4:	Appliance List - Kitchen.....	16-10
Figure 16-5:	Kitchen Layout - Overhead and Shelf Lighting General Locations.....	16-37
Figure 16-6:	Servery Layout- Carshell Wall Elevation	16-43
Figure 16-7:	Servery Layout- Elevation Passenger Aisle.....	16-44
Figure 16-8:	Servery Layout- Top View.....	16-45
Figure 16-9:	Appliance List - Servery	16-47
Figure 16-10:	Servery Layout - Overhead and Strip Light General Locations	16-59
Figure 16-11:	Servery Layout - Display Case Lighting.....	16-60
Figure 16-12:	First Class Bar Layout - Top View	16-66
Figure 16-13:	First Class Bar Layout - Elevation View 1.....	16-67
Figure 16-14:	First Class Bar Layout - Elevation 2	16-68
Figure 16-15:	Appliance List - First Class Lounge Bar.....	16-70
Figure 16-16:	Bar Layout - Overhead, Display Case, and Strip Light General Locations.....	16-81
Figure 16-17:	Cafe Layout - Top View.....	16-86
Figure 16-18:	Cafe Layout - Elevation View 1	16-87
Figure 16-19:	Cafe Layout - Elevation View 2	16-88
Figure 16-20:	Appliance List - Café.....	16-89

16.1 Overview

- a). This chapter defines the technical requirements, interior design and configuration for the four separate food service areas provided for the Long Distance Bi-Level Fleet.
 - i). Kitchen
 - ii). Servery
 - iii). First Class Lounge Bar
 - iv). Café
- b). Compliance with preliminary design concepts included in the specification and attachments does not relieve the Contractor of all the other requirements within the specification.

16.2 General Requirements

- a). This chapter describes the required components and appliances for each of the food service areas, a desired layout, and functional criteria.
- b). All food service area equipment and fittings shall meet the attachment requirements of 49 CFR Part 238.233 and APTA Standard PR-CS-S-006-98.
- c). Compliance with the CFR requirements shall consider the worst-case scenario of the food service equipment when fully loaded with all supplies and an entire stock of fully loaded appliances.
- d). A flexible, easily reconfigurable structural mounting system shall be provided for the food service equipment interface to the carbody.
- e). General Mechanical Requirements
 - i). Food service components shall be designed to minimize noise.
 - ii). Replacement of any major appliance shall not require any disassembly of the food service area structure.
 - iii). Stainless steel fasteners with vibration-damping inserts shall be used to attach the food service area structure to the carbody.
 - iv). Metal surfaces of the food service area shall be suitably grounded to the carbody to prevent electrical shock.
- f). General Appliance Requirements
 - i). All food service appliances shall be heavy-duty grade commercial food industry apparatus, suitable for the rail vehicle operating environment.

- ii). Their structure shall be sufficiently robust for meeting the FRA mounting strength requirements without requiring framing reinforcement, unless otherwise approved by Amtrak.
 - iii). All appliances shall be mounted within the food service area in a manner that complies with regulations regarding attachment strength and resistance to acceleration forces.
 - iv). Wherever possible, appliances of the same manufacturer, model, and part shall be used for ease of spare management and maintenance.
 - v). Appliances with doors shall have mechanical latches, and not solely rely upon magnetic latches to keep doors closed.
 - vi). Appliance change-out time (the time to remove a defective unit, install a replacement unit and verify function of the replacement unit) shall not exceed 30 min. for the food service appliances specified in this chapter.
 - vii). Appliances with refrigeration or freezing systems shall be self-contained units, and not employ "split systems" with separate components located elsewhere such as under the floor.
 - (1) The retention mechanisms shall not interfere with the appliance's operation or routine cleaning or servicing and shall allow the removal and replacement of the appliances within the specified times.
 - viii). All appliances shall be installed to provide adequate ventilation for cooling/heat dissipation and to prevent heat buildup on adjacent surfaces, per the manufacturer's recommendations.
- g). General Water System Requirements
- i). Water system connections to individual appliances shall be made by FDA compliant quick-break connectors, with a labeled quarter-turn water supply ball valve.
 - ii). Any liquid drains shall be directed through the floor to drain under the car and clear of any undercar components, using easily accessible connectors.
 - iii). Potable water from the car supply tank using suitable water backflow checks shall be provided to the food service area for distribution to any appliance requiring the use of water.
 - iv). The potable water supply shall have a particulate filter and an antibacterial filter to purify the water to Public Health Service (USPHS) standards.
 - v). These filters shall be located between the freshwater tanks and the food service area equipment and shall be located for easy cleaning and replacement.
 - vi). These filters shall be identical to those specified for the potable water system on the other cars, to the extent possible.

- vii). Individual ball type shut off valves shall be provided for all appliances requiring the use of water. All water system components shall be of lead-free design.
- viii). Manual ball type drain valves shall be provided to allow draining all of the food service area piping and appliances, either for water system servicing or manual draining of the car in advance of storage, or in anticipation of freezing conditions.
- ix). These valves shall drain the water system to the ground under the car clear of any undercar components. Instructions shall be posted in an approved food service area location providing water draining instructions for the LSA, including the draining of water contained within appliances.
- h). General Sanitation Requirements
 - i). The food service car shall be designed and constructed in full compliance with:
 - (1) US Food and Drug Administration (FDA) Food Code, 2017,
 - (2) FDA Handbook on Sanitation of Railroad Passenger Cars, 1964,
 - (3) Amtrak Food Service Sanitation & Public Health Standards, 1997
 - (4) 21 CFR Part 1250.
 - (5) All applicable Code of Federal Regulations concerning general sanitation, water, and interstate conveyance sanitation for:
 - (a) FDA
 - (b) US Environmental Protection Agency (EPA)
 - (6) The Contractor is required to arrange and comply with all Federal agency review, inspection and certification requirements for the food service area, such as described in 21 CFR Part 1250.41.
 - ii). Certificate Holder
 - (1) Each food service area shall have a 5 in. high by 7 in. wide certificate holder on the inner face of a galley locker door to display under glass the FDA Form 2371, Certificate of Sanitary Construction when issued.
 - iii). The design and installation of countertops, wall panels, floor-to-wall joints, recycling and trash and recycling receptacles and lockers and component mounting shall not permit food particles, debris, liquids or moisture to reside behind, over or under any of their surfaces.
 - (1) Countertops shall have a raised edge on all exposed faces and a cove on all edges adjacent walls and bulkheads and be properly sealed and caulked.

- (2) All outside corners formed by two planes shall have a minimum radius of 0.25 in.
 - (3) Corners formed by three planes shall have a minimum spherical radius of 0.375 in.
 - iv). All approvals, including approvals from the FDA, are the responsibility of the Contractor.
 - (1) The Contractor shall be responsible for correcting any observations found during FDA inspections.
 - (2) All cars shall be certified for conformance with FDA regulations.
 - (3) All approvals shall be supplied with each car history book. **[CDRL 16-01]**
 - v). All countertops and serving counters must be non-porous, corrosive-resistant and easily cleanable surfaces.
 - (1) The countertops for passenger use shall meet all ADA requirements.
 - (2) The countertops in food service preparation areas must comply with all FDA sanitation and lighting requirements.
- i). General Safety Requirements
 - i). All food service equipment shall be designed to accommodate passengers and train crews from the 5th percentile female to the 95th percentile male ranges.
 - ii). Safety of passenger, crew and maintenance personnel shall be a prime consideration in design of all food service equipment.
 - iii). Emphasis shall be placed by the Contractor for inclusion of passenger and LSA handholds throughout the food service car, to assist if the car unexpectedly lurches or sways.
 - (1) They shall be provided for passenger use when entering the car from connecting cars, passing through the car, standing in the food service area, using the condiment stations, at stand-up tables or stools, or other areas where a passenger or crew may be standing.
 - (2) In general, there should be a convenient handhold for passenger use throughout the car.
 - (3) The perimeter of the LSA food service area counters (Arrangement 1 & 2) shall be equipped with a continuous safety handrail, or similar safety assist arrangement.
 - (4) Handrails shall be finished to be consistent with their surroundings and shall not infringe into clear passageway widths as defined by the ADA.

- iv). Projections from the food service area face or edge of countertop which could injure crew members, including knobs, switches, outlets and latches, shall be recessed.
 - (1) There shall be no finger pinch points in the food service area, or elsewhere in the food service car.
- v). In addition to the basic emergency equipment to be provided on all car types, the food service areas shall also have the listed emergency equipment in each food service area subsection.
 - (1) The emergency equipment storage locations shall be labeled in accordance with all applicable Amtrak signage requirements.
-)). General Electrical Requirements
 - i). The food service car electrical distribution system shall provide suitable Head End Power (HEP) and low voltage power supply electrical power distribution, including 208VAC or 120VAC 60 Hz power, to the food service area (see Chapter 15).
 - (1) Each food service appliance shall have an identified dedicated simplex outlet and individual supply circuit breaker and switch.
 - ii). Located in the car main electrical locker shall be all main terminal boards, main circuit breakers and other items required for distribution of food service electrical power to a local food service area electrical panel.
 - (1) Each circuit breaker shall interrupt all lines of the circuit.
 - (2) Circuit breakers and electrical outlets intended to provide a dedicated power circuit to a specific food service appliance shall be permanently and clearly labeled for that appliance.
 - (3) The appliance operation shall be supported during Head End Power (HEP) outages using approved designs.
 - iii). The Contractor shall provide both a complete electrical schematic and a wiring diagram for all food service equipment.
 - iv). Each appliance shall be powered from its own circuit breaker located in the food service equipment electrical locker, and the appliance shall be grounded to the carbody through its wiring harness.
 - (1) Individual labeled electrical outlets shall be provided for each appliance.
 - (2) In addition, a toggle switch shall be provided in an approved food service area location for each appliance to allow the unit to be switched off manually.

- (3) A Light Emitting Diode (LED) pilot shall be provided for each switch, wired so that it will illuminate when power is on at the load side of the respective closed appliance switch.
 - (4) Alternate power connection arrangements may be proposed during design review.
 - v). The food service area shall have a local dedicated circuit breaker panel for LSA use which shall include circuit breakers and switches for the food service equipment and food service lighting.
 - (1) It shall be covered with a polycarbonate door (to allow the positions of the switches and circuit breaker to be seen) with a paddle latch to keep the door closed.
 - (2) The dedicated circuit breaker panel shall meet the requirements in Chapter 13.
 - k). General HVAC Requirements
 - i). The car HVAC system will provide ventilation, heating and cooling to the food service area as part of the overall car HVAC system, as described in Chapter 10.
 - ii). The Contractor shall ensure that the HVAC system is designed to remove the heat produced by the appliances and any other heat sources.
 - (1) HVAC cooling/heating distribution shall be designed to accommodate all Food Service arrangements and be adjustable depending on arrangement load demands.
 - (2) Details to be reviewed during Design Review.
 - iii). The Contractor will supply a heat load analysis to Amtrak for review.
 - (1) All food service equipment shall be installed with sufficient free space between the equipment and walls to permit circulation of cooling/ventilation air in accordance with the manufacturer's recommendations.
 - l). General Lighting Requirements
 - i). All food service appliance area lighting shall be in accordance with APTA Recommended Practice PR-E-RP-012-99 and the latest revision of the USPHS FDA Food Code.
 - (1) All normal light levels along the entire length of the food service area shall be a minimum of 30 foot-candles, and all standby lighting shall provide a minimum of 10 foot-candles.
 - ii). Types and styles of lighting fixtures shall be presented by the Contractor for approval by Amtrak during the design review. All lighting shall be controlled by switches in the food service circuit breaker area.

- iii). Lights shall be located so they will not produce glare, nor shine into the face either of passengers or the LSA.
 - (1) The fixtures selected shall be suitable for the railroad environment and shall be robust, easy to clean and maintainable for the life of the food service area.
- m). General Cart Requirements
 - i). The carts described below are intended to function interchangeably across the fleet and with the Airo platform carts.
 - ii). The carts shall be capable of being used as refrigerated carts and dry storage carts.
 - iii). The intention is for the same carts to be used as rooms service delivery carts. However, if the carts are not sturdy or robust enough for frequent movement throughout all levels and cars of the train, a second cart type may be proposed by the Contractor.
 - (1) If an alternate cart is proposed, the room service delivery carts will require a docking station when they are not in use.

16.3 Material Preferences

- a). The food service and seating areas in each food service area shall be designed to provide an aesthetically pleasing and efficient area for passengers and train crew.
 - i). The Contractor shall be responsible for providing a comprehensive and unified appearance throughout all areas of the car as well as being complimentary and consistent with all other car types built to this Specification.
 - ii). Choice of finish materials shall be submitted to Amtrak for approval.
 - iii). These finish materials shall align as close as possible to the Color, Materials and Finish document attached to this specification and comply with Chapter 19 of this Technical Specification.

16.4 Kitchen Requirements

- a). Vision
 - i). The kitchen area shall be ergonomically designed to minimize the number of steps the chef and kitchen crew needs to take to prepare, plate, and deliver food to passengers.
 - ii). The kitchen area shall be designed with the idea that there is a preparation and a washing area where applicable appliances and features are kept apart as much as possible.
 - iii). Preserving landing spaces and work areas is very important to Amtrak.

- iv). The Kitchen should be a pleasant space to work. The arrangement of the kitchen and kitchen equipment should be safe, practical, and ergonomic with a layout that delivers operational efficiencies.
 - v). The design of the back of house should be future ready – The design of this area should be considered as modular so that equipment can be upgraded or changed as service models and technologies evolve over time.
- b). Desired Layout
- i). The layout in the figures below shows the desired approximate locations and relative footprints for each element of the kitchen from an ergonomic and preparation flow perspective.
 - (1) The Contractor shall use this layout as the basis for the kitchen design and make adjustments as necessary to provide complete functionality using best practices for food service delivery.
 - (2) The Contractor shall submit layouts at each stage of the design review process for Amtrak's review and acceptance. **[CDRL 16-02]**
- c). Appliances
- i). Figure 16-4 lists the desired appliances along with an example part number and the quantity required within the kitchen food service area.
 - (1) Example part numbers are given to establish a starting place for appliance performance and will be finalized during the design reviews.
 - (2) The car builder will propose a compliant manufacturer and part number for each appliance that meets requirements for functionality, shock and vibration, service history, power requirements, and ability to meet crashworthiness requirements for mounting.
 - ii). Detailed functional requirements for each appliance is listed on the following pages.
 - iii). In addition to these requirements, the Contractor shall factor in FDA cleaning clearances, radii, and sanitary design.

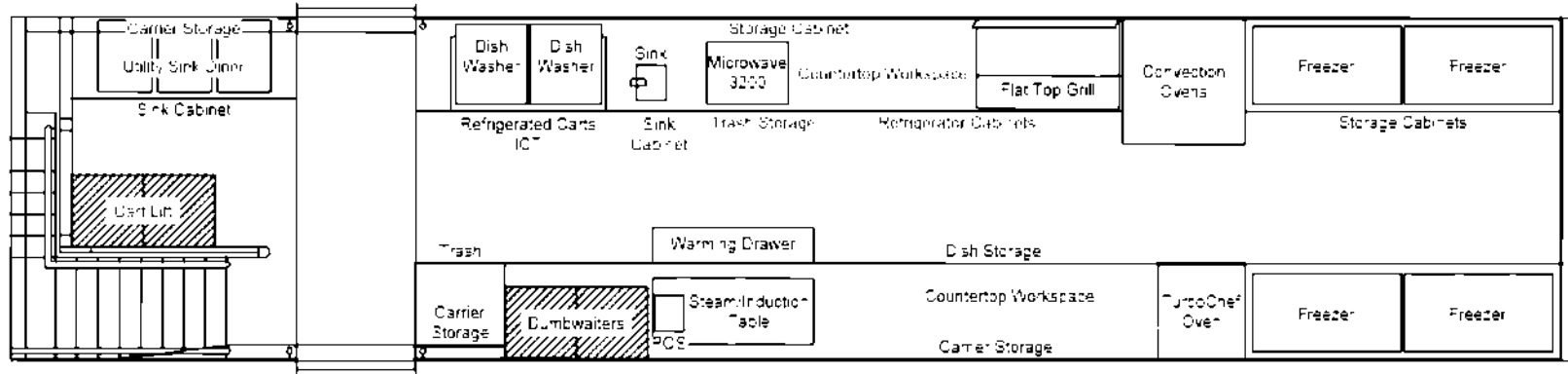

Figure 16-1: Kitchen Layout - Top View

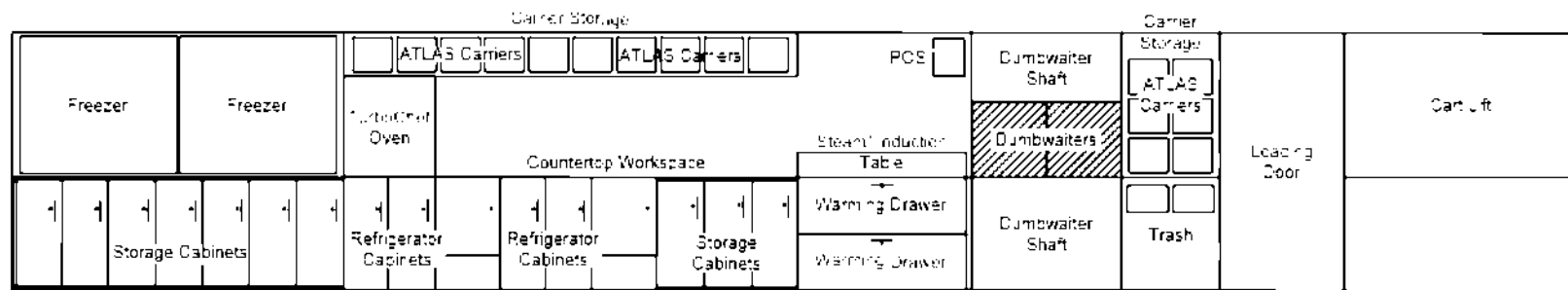

Figure 16-2: Kitchen Layout - Elevation View 1

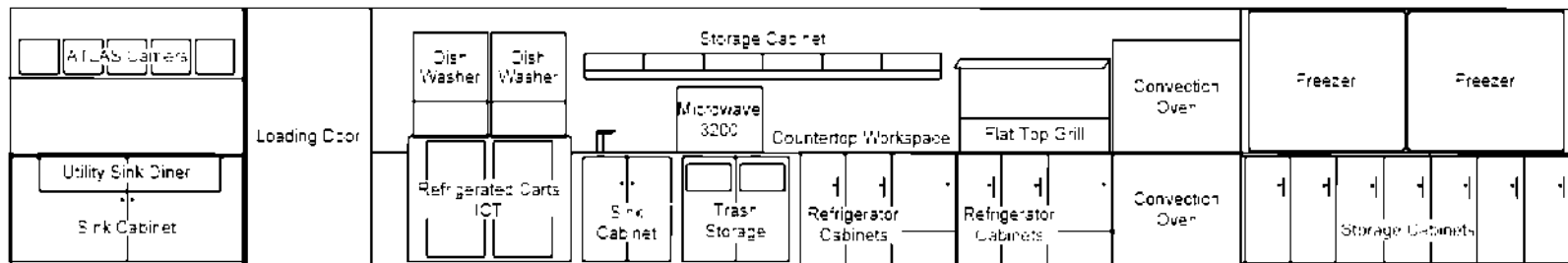

Figure 16-3: Kitchen Layout - Elevation View 2

Figure 16-4: Appliance List - Kitchen

Appliance	Description	Example Part No.	Quantity Desired
Utility Sink	This is a 3-compartment sink used for washing food preparation and storage items.	-	1
Cart Lift	This is a lift system for the refrigerated carts to move between levels of the bilevel car.	-	1
Refrigerated Cart Docking Station (2 cart)	2 cart docking station with cart chiller, cart sensor, temperature monitoring,	Stahl L002923	1
Refrigerated Cart	Insulated food cart with capability to maintain food temperature of 40 degrees F for one hour after loss of power	Bucher BA700036	2
Dishwasher	Dishwasher with 13 racks per hour capacity under heavy setting, holds standard size dish racks, 17" door opening, 0.62 gallons of water per rack, NSF rated high temperature,	Hobart LXeR advansys	2
Handwashing Sink	Sink basin with IR faucet for handwashing purposes, includes soap dispenser and paper towel holder mounting	-	1
Microwave	Steamer oven with 3500W, pull down door, heavy volume, 4 stage cooking, touch control	Amana AMSO35	1
Trash and recycling Storage	Stainless steel module for storing removable trash and recycling bin. Trash and recycling bin is accessible through a drawer.	-	1
Food Service Lifts	This is a lift system for plated food and/or dirty dishes to move between levels of the bilevel car.	-	2
Steam Table/ Induction Table	Hot food well, drop in, (4) 12" x 20" pan capacity with 4" deep well, individual adjustable thermostatic controllers	Alto-Shaam 400-HWI/D4	1
Fold up/Down Counter	A fold up/down countertop mounted in front of the steam table to expand available workspace when in use.	-	1
Flat Top Grille	Countertop griddle with 48" cooking surface, ¾" thick polished steel plate, thermostatic controls, grease trough	Royal Range RTGE-48	1
Rapid Cook Oven	0.83 cu ft capacity, rapid cook, impingement, and convection options, operate each section at different temperatures touch control, ventless	TurboChef PLEXOR M2	1
Convection Oven	Combitherm CombiOven that fits (5) 12"x20' full size hotel pans, stackable kit	Alto-Shaam 6-10E PRO	2
Freezer	Insulated freezer cabinet with ability to keep food goods at or below 0 degrees F	-	4
Warming Drawers	Insulated warming drawer with ability to keep food goods between 60 and 200 degrees F.	-	2
Storage Cabinets	Stainless steel cabinets or open shelving for dry storage to maximize space usage within food service area.	-	As space allows
Refrigerated Cabinets	Insulated refrigerator cabinet with ability to keep food goods between 32 and 40 degrees F	-	4
Countertop Workspace	Clear available workspace for food preparation with 6" backsplash and 0.25" radii.	-	As space allows
ATLAS Carrier Storage	Stainless steel cubbies for ATLAS Carrier storage to maximize space usage within food service area.	-	At least 3
ATLAS Carrier	Atlas sized dry goods container for storage and transport of goods between commissary and food service area	Bucher BA740012	At least 21

CONFIDENTIAL — DO NOT DISTRIBUTE

- (1) Utility Sink
 - (a) A three-compartment sink shall be provided where each sink basin is at least (18" x 24" x 12").
 - (b) The compartments and sink counterspace shall be made from welded stainless steel.
 - (c) Marine edges shall be included on the front edge of the utility sink area.
 - (d) A backsplash of at least 6" shall be included on the other edges of the utility sink area.
 - (e) The radius between the backsplash and the utility sink shall be at least ¾".
 - (f) The three-compartment sink shall include overflow provisions in each sink basin.
 - (g) The overflow piping shall join in a central location before draining through the floor penetration.
 - (h) The drain in the bottom of each sink basin shall be 2" in diameter and shall be capable of being plugged with a ball valve attached to an L shaped rotational lever mechanism.
 - (i) The L shaped rotational mechanism shall extend to the front of the module so that it is easy to reach this lever.
 - (j) All requirements described in the water and waste chapter of this specification shall apply to the utility sink.
 - (k) The faucet for the utility sink shall be centered above the middle sink and shall pivot to the right and left sinks for filling each basin.
 - (l) The faucet shall have a mechanical handle for turning on and off the water flow through the faucet.
- (2) Cart Lift
 - (a) A cart lift for moving both refrigerated and dry goods stored in carts shall be incorporated into the kitchen and servery.
 - (b) The lift requirements are listed in Chapter 6, Carbody.
 - (c) Passengers shall not operate or use these lifts; they are intended for crew use only.
 - (d) The lift shall be capable of being operated manually in the event of power loss or malfunction so that a cart is not trapped within the lift.

- (e) Carts shall be rolled in and rolled out of the lift through door openings.
- (f) The entire Cart Lift shaft system shall be fully enclosed.
- (g) Upper and lower level access points shall be controlled using an Amtrak Coach key unless cart lift station is behind existing access controlled spaces.
- (h) Lift shall be sized for movement of one/two carts with sufficient vertical clearance for service materials placed on the cart top may remain in place during floor transfer.
- (i) The Cart lift shall be powered by cars 72VDC bus.
- (j) The cart lift shall have a maximum weight capacity equal to the entire volume of the cart lift filled with water and shall be posted next to the controls.
- (k) Controls
 - (i) Controls for the lift shall be adjacent to the lift they control.
 - (ii) Controls for the lift shall include the following buttons:
 - 1. Door Operation
 - a. To open and close the doors of the lift.
 - 2. Lift Level Change
 - a. To send the lift to the upper or lower level of the train.
 - (iii) Control buttons shall be illuminated when depressed.
- (l) Status Panel
 - (i) There shall be a small status panel hidden from passenger view adjacent to the cart lift control panel.
 - (ii) The status panel shall have either a display or a row of health status LEDs for each interlock that is required to operate the cart lift.
- (m) Diagnostics
 - (i) The controller and status panel shall include at a minimum the following interlock statuses: "upper doorway closed", "lower doorway closed", "weight sensor", "motor ok", "adjustment ok", "manual override", "manual cut-out"

- (ii) The cart lift controller shall monitor motor current and report preventative maintenance alerts and faults to the car diagnostic system.
 - (iii) The cart lift controller shall record each failed attempts to operate the cart lift and include a snapshot of all interlocking signals with each failed attempt. The data shall be available to maintenance for trend analysis and training.
- (3) Refrigerated Docking Station
 - (a) Refrigerated carts shall be stored within a docking station built into the food service area as a module.
 - (b) Each cart docking compartment shall include carrier stops, guide rails, and retention latches.
 - (c) Drainage from cart condensation shall be directed away from the front of the docking station to avoid flooding, spills, and water leakage onto the floor of the food service area.
 - (i) The module shall have a base pan with a cross break and 0.25" radii on all edges.
 - (d) Locations for the cart docking shall be designed for the carrier door to remain closed when in the stored position.
 - (i) Carts will remain closed in 'stored' configuration due to spacing and optimizing space in the galley.
 - (ii) In order to access goods in a cart, the retention latch must be rotated, and the door of the cart must be opened.
 - (e) The retention latches shall be used to retain the cart in its position.
 - (i) The latches shall rotate 180° so that they can be rotated clockwise or counterclockwise to release the carts.
 - (f) The guide strips inside the docking station shall be made from a polymer material that prevents damage to the carts while also securing them in place to prevent rattling.
 - (i) The guide strips shall be replaceable in case of significant damage
 - (g) Cart Identification Sensor
 - (i) These sensors indicate to the chiller cart if there is at least one cart docked the refrigerated docking station.
 - 1. If there is a cart docked, the chiller will function as

- normal.
- 2. If there are no carts detected, the chiller will not be on.
 - (ii) This will prevent potential damage to the internal components of the chiller.
- (h) Cart Chiller
 - (i) The cart chiller shall be mounted on wheels that allow the cart chiller to easily traverse the threshold of the refrigerated docking station.
 - (ii) The chiller cart is intended to dock semi-permanently inside the refrigerated docking station.
 - 1. This chiller would only be removed for maintenance or replacement.
 - (iii) The cart chiller shall be roughly (12" x 37" x 21") and shall be interchangeable with the chiller carts used in the Amtrak Intercity Procurement. Example part number listed as STAHL L002923.
 - (iv) The cart chiller shall function to keep food at or below 40°F.
 - 1. The cart chiller will be suitably insulated to prevent all condensation from appearing on the outside of the module.
 - 2. The temperature within the exhaust and return ducts of the module shall be monitored and reported to wayside.
 - (v) There will be alarm annunciation to the train crew that the refrigerated display is malfunctioning if the temperature in the display case reaches 41°F for a continuous one-hour period or if the temperature ever reaches 50°F.
 - (vi) The cart chiller shall be suitably sized to maintain pre-chilled stock to 40 °F or lower within 90 min of startup as determined by refrigeration system capabilities.
 - (vii) The cart chiller will be qualified using the EN ISO 23953-2:2015 test.
 - (viii) Refrigerant used in the refrigeration equipment shall be presented and approved by Amtrak during PDR.
 - (ix) The cart chiller shall have the following features:

1. Push handle at the front
 2. Mounted on 4 wheels
 3. Quick locking mechanism to secure in docking station
 4. Connection to the cooling area on the back side
 5. Power connection for 120V AC/48V DC with Harting plug
 6. Protection against evaporator freeze-up during low load operation
 7. Digital Controller with touch panel that includes alarm annunciation, status displays, password protection for setting adjustment
- (x) The refrigeration system shall be controlled by the suction line pressure signal and the supply air and exhaust air temperature sensors.
1. Depending on the changes in pressure, the speed of the compressor shall be adjusted accordingly between the minimum and maximum speed.
 2. The unit shall be turned on and off based on the temperature sensor readings.
- (i) Ducting
- (i) The ducting on the back of this module directs the warm and cool air to and from the food carts so that the carts are always within the expected temperature range.
 - (ii) The ducting also is directed to the car's HVAC exhaust system to take heat away from the refrigeration equipment.
 - (iii) The ducting shall be insulated so that the condensation is limited as much as possible.
 - (iv) Insulation should be mechanically fastened to the duct with no exposed insulation fibers. The use of insulation tape is not allowed.
- (j) Electrical Connection
- (i) The electrical connection between the chiller cart and the docking station shall provide a quick connect, not damage any electrical connectors, and be properly insulated from moisture.

- (4) Refrigerated Cart
- (a) Carts are intended to move food items from the commissary to the train, dock in their compartment and be taken back to commissary for restocking after a trip is complete.
 - (b) The cart shall be roughly (16" x 21" x 37") and shall be interchangeable with the carts used in the Airo fleet. Example part number listed as Bucher BA700036.
 - (c) The refrigerated cart shall be delivered with 12 trays loaded on shelves inside.
 - (d) The cart shall be able to move seamlessly in and out of the docking station.
 - (e) The Contractor is responsible for ensuring that the tolerances between the docking station and the refrigerated cart both:
 - (i) Do not cause rattling of the cart while the train is in motion.
 - (ii) Are not so tight that the cart is damaged during docking and undocking.
 - (f) Carts shall continue to keep items at FDA acceptable temperatures from the time food is placed inside until the food is removed for consumption.
 - (i) Food cart interior will be accessed semi-regularly and will be docked to a refrigeration docking station when used as a refrigerated cart on the café car.
 - (g) The cart is expected to function with limited wear and tear damage for the lifespan of the train.
 - (h) Stainless steel push-to-close or slam latches shall be used on the cart doors.
 - (i) Sealant on the door gasketing is subject to FST testing- silicone is recommended.
 - (i) The cart will come with a padlock hasp for locking the contents of the cart when the cart is unattended.
 - (j) A card holder shall be provided at the top of the cart door.
 - (i) This material will be aluminum and clear anodized.
 - (k) A 75 mm diameter wheel will be used on all carts.
 - (i) The top of the cart handle shall be 30 mm above the top surface of the cart to allow for items to be placed on top of the cart during transport.

- (l) The cart shall be capable of a maximum loading of 115 kg, or similar as determined by the supplier.
 - (i) The cart shall be 25 kg empty, or similar as determined by the supplier.
- (m) The bottom of the module will be a single pan that includes the lower portion of the sidewalls to contain any condensation.
 - (i) The main sidewalls of the module will be fastened to the lower pan so that water does not exit the module.
 - (ii) The cart module will be adequately sealed to prevent leakage of cart contents into the galley during normal train operation.
- (n) The inner and outer surfaces of the cart will be non-porous, corrosive resistant, and easily clean-able.
 - (i) Any seams will need to be sealed with silicon or mounted with gaps of < 1/32" to meet FDA requirements.
 - (ii) No sharp edges, chips, or surface defects will be present.
 - (iii) The interior of the cart shall have 0.25" radius or greater on all corners for cleaning.
- (o) The cart in conjunction with a compliant working chiller shall function to keep food at or below 40°F.
- (p) The cart will be suitably insulated to prevent all condensation from appearing on the outside of the module.
- (q) The cart shall be suitably insulated to allow a compliant working chiller to bring room temperature stock down to 40 °F or lower within 90 min from startup or pull down pre-chilled stock to 40 °F or lower within 90 min of startup as determined by refrigeration system capabilities. (i.e., no gaps or cold air leaks)
- (r) The cart shall be capable of holding up to 12 trays inside.
 - (i) The tray dimensions will be determined by the inside dimensions of the cart.
 - (ii) These dimensions will be relayed in drawings to the customer.
 - (iii) It is understood that trays for these carts will likely be custom size.
 - (iv) Trays shall be provided by the Contractor within the cart upon delivery.

- (s) The refrigerated cart module will be aesthetically pleasing. The supplier shall provide sublimation treatment to all cart panels.
 - (t) The supplier shall provide either anodizing with clear or single color on the structural extrusions for the cart.
 - (u) Any required labeling from the manufacturer shall be placed in a location that is not visible while the cart is in the stored position.
 - (v) The Contractor shall provide a manufacturer drawing showing all critical dimensions for the cart for Amtrak approval.
- (5) Dishwasher
- (a) A purchased, off the shelf dishwasher shall be provided that meets or exceeds the features from the example part number. Example part number listed as Hobart LXeR advansys.
 - (i) Dishwasher with 13 racks per hour capacity under heavy setting,
 - (ii) holds standard size dish racks,
 - (iii) 17" door opening,
 - (iv) 0.62 gallons of water per rack,
 - (v) NSF rated high temperature
- (6) Handwashing Sink
- (a) A sink shall be provided where the sink basin is at least (12" x 10" x 6").
 - (b) The basin and sink counterspace shall be made from welded stainless steel.
 - (c) Marine edges shall be included on the front edge of the handwashing sink area.
 - (d) A backsplash of at least 6" shall be included on the other edges of the utility sink area.
 - (e) The radius between the backsplash and the utility sink shall be at least ¾".
 - (f) The drain in the bottom of the sink basin shall be 1.25" in and shall be capable of being plugged with a ball valve attached to an L shaped rotational lever mechanism.
 - (g) The L shaped rotational mechanism shall extend to the front of the module so that it is easy to reach this lever.

- (h) All requirements described in the water and waste chapter of this specification shall apply to the utility sink.
 - (i) The faucet for the handwashing sink shall use an IR sensor to allow water to run through the faucet. The faucet shall be sized and shaped to allow the water to flow to the center of the handwashing sink basin.
 - (j) Power for the faucet shall be hard wired. Battery replacement arrangements are prohibited.
 - (k) The soap dispenser used by Amtrak is manufactured by Celeste Industries Corporation.
 - (i) The Contractor should supply the mounting base for the soap dispenser.
 - (ii) The base is made of Delrin and is tapered.
 - (l) The paper towel holder shall be SanTRAL Plus PTU 31 E ST or similar.
 - (i) This shall have anti-fingerprint coating, have a filling volume of 500-600 sheets of folded paper towels, be lockable, and be wall mounted.
- (7) Microwave
- (a) A purchased off the shelf item shall be provided that meets or exceeds the features from the example part number. Example part number listed as Amana AMSO35.
 - (i) Steamer oven with 3500W,
 - (ii) pull down door,
 - (iii) heavy volume,
 - (iv) 4 stage cooking,
 - (v) touch control
 - (b) A spare microwave shall be provided in storage in the event of failure
- (8) Trash and Recycling Storage
- (a) Trash and recycling will be stored in a stainless-steel module with drawers for the trash and recycling bins to slide in and out of the module.

- (b) The drawer shall be mounted on sturdy, durable, cleanable drawer slides that allow for continuous cycles of opening and closing and operate smoothly.
 - (c) The drawer shall operate with push to open, slam to close latches.
 - (d) The stainless-steel or aluminum trash and recycling bins shall be completely sealed so that no liquid can escape the trash and recycling bin.
 - (i) These bins are intended to be removable for emptying the trash and recycling and for cleanability.
 - (e) In this food service area, the cumulative minimum internal volume for the trash and recycling required is 44 cu ft.
 - (i) 18.8 cu ft (31 in horizontal x 35 in tall x 30 in deep).
 - (ii) Plus 25.2 cu ft (39 in horizontal x 35 in tall x 32 in deep).
 - (f) The trash and recycling drawers shall be designed with cleanability features including 0.25" radii at the bottom of the drawer and there shall be no fastener protrusions into the base of the drawer.
 - (g) An option of including a compactor to the trash and recycling storage area to maximize trash and recycling storage capacity shall be proposed and can be exercised at Amtrak's discretion.
- (9) Food Service Lifts
- (a) General
 - (i) Two Food Service Lifts shall be included in the kitchen and Servery areas.
 - (ii) One Food Service Lift shall be used for plates of food to be delivered to the second level for passenger consumption of meals.
 - (iii) The other Food Service Lift shall be used for used dishes to return to the kitchen for washing.
 - (iv) The Food Service Lift requirements are listed in Chapter 6, Carbody.
 - (v) Passengers shall not operate or use these Food Service Lifts. These are intended for crew use only.
 - 1. The Food Service Lift shall be capable of being operated manually in the event of power loss or malfunction so that items are not trapped within the

Food Service Lift.

- (vi) The entire Food Service Lift shaft system shall be fully enclosed.
 - (vii) Food Service Lift shall be provided on the café car to facilitate the movement of service trays and bussing tubs between the food service area and the kitchen below.
 - (viii) Food Service Lift shall be capable of moving 4 serving trays with plated food, dish covers and associated materials or a fully loaded bussing tub.
 - (ix) Upper level access door shall be include locking feature using the Amtrak coach key /keycard. The lower door shall include a hand operated latch function to secure the door.
 - (x) Food Service Lift operation shall be available at any time during service operation.
 - (xi) All surfaces of the lift shall be stainless steel or alternate material with anti-microbial coatings as approved by Amtrak.
 - (xii) The Food Service Lift shall be powered by cars 72VDC bus.
 - (xiii) Food Service Lift shall include an interlock to prevent movement unless both doors are closed.
- (b) Controls
- (i) Controls for the Food Service Lift shall be adjacent to the Food Service Lift they control.
 - (ii) Controls for the Food Service Lift shall include the following buttons:
 - 1. Door Operation
 - a. To open and close the doors of the lift.
 - 2. Lift Level Change
 - a. To send the lift to the upper or lower level of the train.
 - 3. Control buttons shall be illuminated when depressed.
- (c) Status Panel
- (i) There shall be a small status panel hidden from passenger view adjacent to the cart lift control panel.

- (ii) The status panel shall have either a display or a row of health status LEDs for each interlock that is required to operate the cart lift.
- (d) Diagnostics
 - (i) The controller and status panel shall include at a minimum the following interlock statuses:
 1. "upper doorway closed",
 2. "lower doorway closed",
 3. "weight sensor",
 4. "motor ok",
 5. "adjustment ok",
 6. "manual override",
 7. "manual cut-out"
 - (ii) The Food Service Lift controller shall monitor motor current and report preventative maintenance alerts and faults to the car diagnostic system.
 - (iii) The Food Service Lift controller shall record each failed attempts to operate the cart lift and include a snapshot of all interlocking signals with each failed attempt.
 1. The data shall be available to maintenance for trend analysis and training.
- (10) Steam / Induction Table
 - (a) A purchased off the shelf item shall be provided that meets or exceeds the features from the example part number. Example part number listed as Alto-Shaam 400-HWI/D4.
 - (i) Hot food well,
 - (ii) drop in,
 - (iii) (4) 12" x 20" pan capacity with 4" deep well,
 - (iv) individual adjustable thermostatic controllers
- (11) Fold Up/Down Counter
 - (a) A stainless-steel workspace required for food preparation shall be provided that can fold down into a stored location or up to

create an additional workspace area in front of the steam/induction table.

- (b) This fold up/down counter shall be proposed as a potential solution for plating food from the grille.
 - (c) The countertop shall be of a usable height between 36" and 38" tall.
 - (d) The countertop shall be attached to the adjacent modules with no holes for fasteners on the top of the workspace. The workspace shall be hinged on the bottom of the counter.
 - (i) Special consideration shall be given to this area to mitigate pinch points as much as possible
 - (e) The countertop shall be capable of holding a point load of 300 lbs. on the front exposed edge without collapsing or causing damage.
 - (f) The edges of the countertop shall have generous radii (greater than 1") to mitigate injury from accidentally walking into the countertop when extended.
 - (g) In this food service area, the minimum surface area for flip up counter workspace required is 4.75 sq ft. (57 in horizontal and 12 in deep).
- (12) Flat Top Grille

- (a) A purchased off the shelf item shall be provided that meets or exceeds the features from the example part number. Example part number listed as Royal Range RTGE-48.
 - (i) Countertop griddle with 48" cooking surface, 3/4" thick polished steel plate,
 - (ii) thermostatic controls,
 - (iii) grease trough
 - (iv) Shall be accompanied by exhaust hood with a fire damper.
 - 1. This shall be an overhead cabinet exhaust hood with 120 VAC control and remote 208VAC 3-Phase exhaust fan. The suggested part number is Gaylord: CG3-BDL-XXX; however, Amtrak does not want any water sprays.
 - 2. Exhaust from the hood should not result in grease collecting on the car's exterior.

(13) Rapid Cook Oven

- (a) A purchased off the shelf item shall be provided that meets or exceeds the features from the example part number. Example part number listed as TurboChef PLEXOR M2.
 - (i) 0.83 cu ft capacity
 - (ii) rapid cook, impingement, and convection options,
 - (iii) operate each section at different temperatures
 - (iv) touch control,
 - (v) ventless

(14) Convection Oven

- (a) A purchased off the shelf item shall be provided that meets or exceeds the features from the example part number. Example part number listed as Alto-Shaam 6-10E PRO.
 - (i) Combitherm CombiOven
 - (ii) fits (5) 12'x20' full size hotel pans,
 - (iii) stackable kit

(15) Freezer

- (a) The freezer shall function to keep food at or below 0°F.
- (b) The freezer shall be suitably insulated to prevent all condensation from appearing on the outside of the module.
- (c) The temperature within the module shall be monitored and reported to wayside.
- (d) There shall be alarm annunciation to the train crew that the freezer is malfunctioning if the temperature in the freezer reaches 1°F for a continuous one-hour period or if the temperature ever reaches 5°F.
- (e) Drainage for the freezer condensation shall take into account ice melt in the freezer and condensation generated by the evaporator.
- (f) The freezer shall be easily cleanable with a base pan that has a backsplash and 0.25" radii.
- (g) In this food service area, the cumulative minimum internal volume for each freezer required is 27 cu ft. (46 in horizontal x 40 in tall x 26 in deep). Four total freezers are included in this

area for a total of 108 cu ft of internal freezer volume at a minimum in this area.

- (h) At least 5 adjustable shelves shall be included in the freezer.
- (i) Refrigerant used in the refrigeration equipment shall be presented and approved by Amtrak during PDR.

(16) Warming Drawer

- (a) A warming drawer shall be placed directly below the steam/induction table. The module shall be constructed from stainless steel.
- (b) In this food service area, the cumulative minimum internal volume for the warming drawer required is 7.3 cu ft. (44 in horizontal x 12 in tall x 24 in deep).
- (c) The drawer shall be mounted on sturdy, durable, cleanable drawer slides that allow for continuous cycles of opening and closing and operate smoothly.
- (d) The drawer shall operate with push to open, slam to close latches.
- (e) The warmer shall be suitably insulated to maintain temperature ranges from 60 degrees F to 200 degrees F and the temperature shall be controlled or set with up and down arrow buttons.
- (f) There shall be a digital temperature display that indicates the set temperature and a signal to identify when the drawer is outside of the setpoint by more than 5 degrees.
- (g) The drawer shall be sized to be capable of holding bread rolls, hotel pans, and potatoes.

(17) Storage Cabinets

- (a) Storage Cabinets shall be constructed from stainless-steel.
- (b) These modules shall be designed to retain goods while the train is in motion.
- (c) Storage cabinets can come in the form of a cabinet with hinged doors or open shelving with retaining bars.
- (d) This will depend on the item stored in each location and shall be determined with Amtrak during the design reviews.
- (e) Storage cabinets that function as cabinets shall have:
 - (i) hinged doors with stainless-steel hinges,

- (ii) push to open, slam to close latches,
- (iii) door swing limiting mechanism to prevent the doors from colliding and denting
- (iv) option for adjustable shelving to accommodate varying products
- (f) Storage cabinets that function as shelves shall have:
 - (i) Option for adjustable shelving to accommodate varying products
 - (ii) Stainless steel retention bars to prevent items from sliding off the shelf while the train is in motion.
- (g) In this food service area, the cumulative minimum internal volume for the storage required is 180 cu ft
 - (i) 89.9 cu ft. (148 in horizontal x 35 in tall x 30 in deep).
 - (ii) Plus 63.1 cu ft (104 in horizontal x 35 in tall x 30 in deep).
 - (iii) Plus 26 cu ft (114 in horizontal x 20 in tall x 20 in deep)
- (18) Refrigerated Cabinet
 - (a) The temperature within the module shall be monitored and reported to wayside.
 - (i) There will be alarm annunciation to the train crew that the refrigerated display is malfunctioning if the temperature in the display case reaches 41°F for a continuous one hour period or if the temperature ever reaches 50 °F.
 - (b) The refrigerated display shall be suitably sized to bring room temperature stock down to 40 °F or lower within 90 min from startup.
 - (i) The refrigerated display shall be suitably insulated to maintain temperature within limits during a power loss of 60 min.
 - (c) The refrigerated display shall function to keep food at or below 40°F.
 - (i) The display case will be suitably insulated to prevent all condensation from appearing on the outside of the module.
 - (d) Drainage for the refrigerated cabinet condensation shall take into account liquid spills and condensation generated by the evaporator.

- (e) Shelves in the refrigerated cabinet shall be mounted on drawer slides that allow ease of access and cleaning for each storage area within the refrigerated cabinet.
 - (i) Shelves shall have sufficient strength to hold 30 lbs. of goods.
 - (ii) Shelves shall have sufficient perforations to allow for airflow within the refrigerated cabinet to maintain required temperatures.
 - (iii) Shelves shall have a short raised, hemmed edge on all sides to prevent items from sliding off the shelf while the train is in motion.
 - (iv) Shelf drawers shall only slide out when activated so that if the train lurches suddenly, the drawers do not slide out on their own.
 - (v) The shelf shall be mounted on sturdy, durable, cleanable drawer slides that allow for continuous cycles of opening and closing and operate smoothly.
 - (f) Refrigeration cabinet doors shall be constructed from stainless-steel with sufficient insulation to help maintain temperatures within the cabinet and to prevent condensation on the outside of the doors.
 - (g) In this food service area, the cumulative minimum internal volume for the refrigerated cabinets required is 99 cu ft. (184 in horizontal x 31 in tall x 30 in deep).
 - (h) Refrigeration equipment shall be easily accessible behind a plate with a grille for air flow and locked with square locks for maintenance or replacement of equipment. Refrigeration equipment shall be mounted on a removable skid for changeout that will constitute as the LRU for the refrigerated cabinet.
 - (i) Refrigerant used in the refrigeration equipment shall be presented and approved by Amtrak during PDR.
- (19) Countertop Workspace
- (a) A stainless-steel workspace is required for food preparation.
 - (b) The workspace shall have 6" backsplash and 0.25" radius minimum for cleanability.
 - (c) The countertop shall be of a usable height between 36" and 38" tall.
 - (d) The countertop shall be attached to the adjacent modules with no holes for fasteners on the top of the workspace.

- (e) In this food service area, the minimum surface area for workspace required is 78.9 sq ft (175 in horizontal and 65 in deep).

(20) ATLAS Carrier Storage

- (a) ATLAS carriers shall be stored within carrier compartments built into the food service area module.
- (b) Each carrier compartment shall include carrier stops, guide rails, and retention latches.
- (c) Carrier storage modules shall be made from stainless-steel.
- (d) Locations for the carriers are designed for the carrier door to remain closed when in the stored position.
 - (i) Carriers will remain closed in 'stored' configuration due to spacing and optimizing space in the galley.
 - (ii) In order to access goods in a carrier, the retention latch must be rotated, and the door of the food storage container must be opened.
- (e) The carrier storage compartments will include carrier stops to ensure the carrier is located toward the front of module.
- (f) The retention latches shall be used to retain the carrier in its position. The latches shall rotate 180° so that they can be rotated clockwise or counterclockwise to release the carriers.
- (g) The guide strips inside the storage cabinets shall be made from a polymer material that prevents damage to the carriers while also securing them in place to prevent rattling.
 - (i) The guide strips shall be replaceable in case of significant damage

(21) ATLAS Carrier

- (a) This carrier is designed to fit into modules throughout the galley as dry storage containers.
- (b) This carrier is made from standard Atlas carrier dimensions and is subject to a 25lb single person lift regulation.
- (c) This includes the weight of the carrier and the contents of the carrier.
- (d) The carrier shall be able to move seamlessly in and out of the carrier storage compartments and the Contractor is responsible for ensuring that the tolerances between the storage location and the carrier both do not cause rattling of the carrier while the train

is in motion and is not so tight that the carrier is damaged during docking and undocking.

- (e) The carrier is expected to function with limited wear and tear damage for the lifespan of the train.
 - (f) Stainless steel push-to-close or slam latches shall be used on the carrier doors. Sealant on the door gasketing is subject to FST testing- silicone is recommended by Siemens.
 - (g) A card holder shall be provided at the top of the cart door. This material will be aluminum and clear anodized.
 - (h) The carrier shall be capable of a maximum loading of 9 kg, or similar as determined by the supplier. The carrier shall be 2.5 kg empty, or similar as determined by the supplier.
 - (i) The carrier module will be adequately sealed to prevent leakage of carrier contents into the galley during normal train operation.
 - (j) The inner and outer surfaces of the carrier will be non-porous, corrosive resistant, and easily cleanable.
 - (i) Any seams will need to be sealed with silicon or mounted with gaps of < 1/32" to meet FDA requirements.
 - (ii) No sharp edges, chips, or surface defects will be present. The interior of the carrier shall have 0.25" radius or greater on all corners for cleaning.
 - (k) In alignment with the Atlas Standard, this carrier shall be capable of holding 4 half size Atlas trays.
 - (l) The carrier module will be aesthetically pleasing.
 - (i) The supplier shall provide the carrier with sublimation treatment to only the door of the carrier.
 - (m) The supplier shall provide either anodizing with clear or single color on the structural extrusions for the carrier.
 - (n) Any required labeling from the manufacturer shall be placed in a location that is not visible while the carrier is in the stored position.
 - (o) The Contractor shall provide a manufacturer drawing showing all critical dimensions for the cart for Amtrak approval.
- d). Functional Criteria
- i). The following items shall be reviewed with the criteria listed below for each.
 - ii). Sanitary Design Review Criteria

- (1) Appropriate cleaning radii of at least 0.25" on worksurfaces and 0.75" on sink areas.
 - (2) Backsplashes of at least 6" on worksurfaces and sink areas.
 - (3) Appropriate cleaning clearances around appliances such that a 95th percentile male can fit their hand and a rag easily between objects for cleaning.
 - (4) All edges and seams are sealed with food grade silicone sealant and gaps greater than 1/32" are sealed in food storage, food preparation, and all other food related areas such as trash compartments shall be sealed in this manner.
 - (5) Floor drains are provided for locations prone to spills and leaks, especially near water piping to eliminate water pooling on the floor.
 - (6) Openings are protected from allowing pests and vermin to congregate
 - (7) Proper sealing methods are used to prevent moisture from corroding or otherwise damaging the food service area
 - (8) All drain pans and catches are accessible for cleaning
 - (9) No tools are required to remove objects subject to daily cleaning rituals
- iii). Refrigeration and Freezer Equipment Review Criteria
- (1) Temperature Monitoring System Functionality
 - (a) Temperature monitoring shall be accomplished through a set of redundant sensors.
 - (i) The refrigeration controller shall relay temperatures for each of the refrigerated modules locally and in one location on a panel in the kitchen.
 - (b) Additionally, temperatures shall be reported to wayside through the use of a PT100 sensor.
 - (i) The PT100 sensor and the controllers for the equipment shall be calibrated to ensure they are reporting the same temperature.
 - (ii) Temperatures shall be logged and accessible for at least a 6 month period of time after the date of data collection.
 - (c) Temperatures for the refrigerated food carts shall be monitored in the ducting between the refrigerated docking station and the refrigerated cart.

- (i) Industry standard is to monitor the temperature and combine 80% of the temperature for the return air and 20% for the supply air.
 - (ii) This calculation shall be used to determine the likely warmest temperature of the air in the food cart and shall inform the setpoint and need for temperature adjustment.
 - (d) Temperatures for refrigerated cabinets shall be monitored directly in the refrigeration cabinet at the warmest temperature location and shall inform the setpoint and need for temperature adjustment.
 - (e) Presently, Amtrak monitors the temperature of a refrigerated food cart by placing a yoghurt in the center of the cart and manually records the temperature of the yoghurt on an interval. If the yoghurt is out of temperature the food in the cart is considered out of temperature and therefore spoiled. The Contractor shall provide a system that consistently functions without allowing the yoghurt to test out of temperature and cause loss of revenue from spoiled goods.
- (2) Type Tests
- (a) Type Tests for refrigeration and freezer systems shall be evaluated using ISO 23953-2 to determine the temperature probe location and validate performance of the system and produce a test report for Amtrak's evaluation and approval as specified in ISO 23953-2 **[CDRL 16-03]**:
 - (b) The following elements of design validation are of particular interest to Amtrak and shall be performed as type tests if information is not included in the ISO 23953-2 test report:
 - (i) Operational Temperature
 1. The system shall maintain food safe temperatures between 33°F to 40°F (1°C to 4°C) consistently for 8 hours.
 2. The freezer module will need to maintain temperature ranges below 0°F (-18°C) consistently for 8 hours.
 3. The supplier will propose a test to show the units maintain operational temperature under standard conditions:
 - a. 74.6°F (23.7°C) and 55% rH.
 - b. An allowable tolerance to this would be +/- 2 degrees F and +/- 5%.

4. The refrigeration systems shall be suitably insulated to maintain the specified temperature limits during a power loss of 60 minutes to avoid condemning of perishable food products.
 5. The refrigeration system shall have real-time and remote temperature monitoring and alarm annunciation capabilities that shall alert onboard crew.
 6. The Contractor shall propose a test to show the units maintain operational temperature under standard conditions:
 - a. 74.6°F (23.7°C) and 55% rH.
 - b. An allowable tolerance to this would be +/- 2 degrees F and +/- 5%.
- (ii) Probe Placement
1. The temperature probe will need to be placed in the warmest location of the refrigerated compartment so that all food items stay within the acceptable temperature range.
- (iii) Air Flow
1. The air flow through the module will need to be evaluated to ensure that there are no warm air pockets within the refrigerated compartment.
- (iv) Operational Load Testing
1. The operational load of the refrigeration module needs to be evaluated to ensure that the refrigeration unit functions within the acceptable temperature range with simulated service loading conditions.
 2. Amtrak will provide loading conditions prior to test procedure approval.
 3. Three total tests will satisfy the operational load requirement: full load, half load, empty load.
 4. The operational temperature of the refrigeration system should maintain food safe temperatures.
 5. The refrigeration module will need to maintain temperature ranges between 33°F to 40°F (1°C to 4°C) consistently for 8 hours.
 6. The freezer module will need to maintain

temperature ranges below 0°F (-18°C) consistently for 8 hours.

7. The Contractor shall propose a test to show the units maintain operational temperature under standard conditions:
 - a. 74.6°F (23.7°C) and 55% rH.
 - b. An allowable tolerance to this would be +/- 2 degrees F and +/- 5%.

(v) Condensation Evaluation

1. The refrigeration module, freezer, and chilled cart modules shall function with zero condensation on the outside surface of a module when exposed to the following environmental conditions:
 - a. 74.6°F (23.7°C) and 55% rH.
 - b. An allowable tolerance to this would be +/- 2 degrees F and +/- 5%.
 - c. Zero condensation is defined as no fogging, beading, or dripping liquid on any outside surface of the module.
2. The Contractor shall perform a test to observe modules while they are functioning at the specified temperatures for 8 hours.

(vi) Pull Down

1. The refrigeration and freezer modules are expected to pull down to temperature within 60 min with an inlet temperature of 70°F and repeated with inlet temperature of 110°F.
2. The module will be completely empty for this test.
3. The refrigeration unit shall reach a temperature range of 33-40°F within the specified time.
4. The freezer unit shall reach a temperature of below 0°F within the specified time.

iv). Warming Equipment Review Criteria

- (1) Type Tests for warming equipment shall be evaluated using DIN 18868-2 to determine the temperature probe location and validate performance of the system and produce a test report for Amtrak's evaluation and approval as specified in DIN 18868-2 **[CDRL 16-04]**

- e). Additional Equipment Requirements
 - i). Crew Comfort
 - (1) Two crew tip up seats shall be provided
 - (2) Handholds shall be provided at locations determined during the design review process
 - ii). HVAC
 - (1) Food service areas generate a large amount of ambient heat, smells, and humidity in the air; as a result, the HVAC system calculations must take into account the appliances and usage case of each food service area. Detailed HVAC requirement information can be found in Chapter 10, HVAC System.
 - (2) Kitchen Area Ventilation
 - (a) Ventilation to area in the kitchen shall include appliance generation of large amount of ambient heat, smells, and humidity in the air.
 - (b) HVAC shall be separately controlled for the kitchen for mitigation of the issues listed above and for staff comfort.
 - (3) Appliance-Specific Ventilation
 - (a) Ventilation to specific appliances is required.
 - (b) This ventilation can come in the form of recycled air through the HVAC system or directly exhausting the outlet air for an appliance.
 - (c) The Contractor shall submit a proposal for which appliances listed below will be directly exhausted and provide all relevant calculations as justification.
 - (d) The submittal will be subject to Amtrak's review and approval during the design review process. **[CDRL 16-05]**
 - (i) Ovens
 - 1. Convection Ovens
 - 2. Rapid Cook Ovens
 - 3. Microwave Ovens
 - (ii) Refrigeration
 - 1. Refrigerated Docking Station

2. Refrigerated Storage
 - (iii) Freezer
 - (iv) Other Appliances
 1. Steam/Induction Table
 2. Flat top Grille
 3. Dishwasher
- iii). Electrical Equipment
 - (1) Electrical equipment information is shared in the points below; and detailed electrical requirements can be found in Chapter 15, Electrical System.
 - (2) Convenience Outlets
 - (a) Convenience outlets shall be located during design reviews after discussion and approval from Amtrak.
 - (b) At least 8 duplex convenience outlets shall be located within the kitchen food service area.
 - (c) Only the convenience outlet near the attendant seat shall have USB ports.
 - (d) General purpose convenience outlets in these areas shall not have USB ports.
 - (3) Appliance Outlets
 - (a) Appliance outlets shall be located directly behind a desired appliance.
 - (b) The outlets shall be properly sized and selected to safely power each appliance and the electrical system shall provide a dedicated breaker for each type of outlet.
 - (c) Appliance outlets shall not have USB ports.
 - (4) POS Ticket Screen Outlet
 - (a) POS Ticket Screen Outlet shall be linked to the POS in the Serverry with both communications cabling and share the same electrical circuit and dedicated breaker as the POS.
 - (b) The POS outlet shall have USB ports.
 - (c) The POS outlet must be available on car battery power and follow the battery load table 15-3: Power Phase Matrix.

iv). Lighting

- (1) Lighting general information is shared in the points below; and detailed lighting information can be found in Chapter 13, Lighting System.
- (2) The points below are accompanied with diagram to show approximate lighting locations and types.
- (3) Overhead Lighting
 - (a) Overhead lighting shall be from flush mounted panel lights in the ceiling panels and/or from spotlights.
 - (b) Overhead lighting can be turned off if the car lighting mode is set to night mode.
 - (c) These overhead light fixtures cannot be required to meet FDA light intensity level requirements for food preparation counters, sinks, and workspaces.
- (4) Shelf Lighting
 - (a) Shelf lighting will be from surface mounted strip lights. These strip lights will be different brightness levels based on the area they are illuminating.
 - (b) Shelf lighting alone shall be the main source of illumination to meet FDA light intensity level requirements for food preparation counters, sinks, and workspaces.
 - (c) To illuminate a shelf, the shelf or underside of the top of the module above the shelf shall have a strip light mounted.
 - (d) To illuminate a workspace, the underside of the shelf above the workspace shall have a strip light mounted.

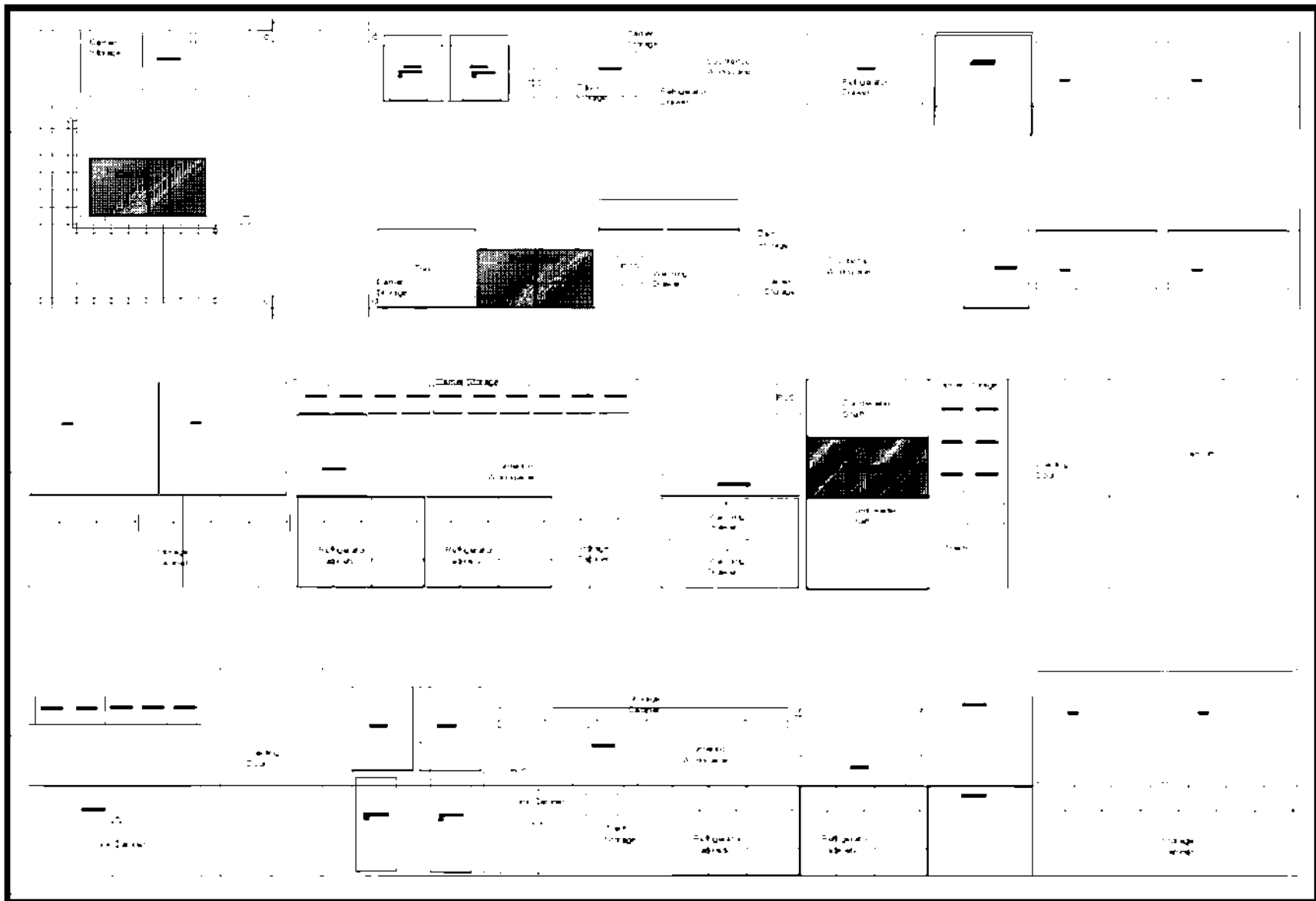

Figure 16-5: Kitchen Layout - Overhead and Shelf Lighting General Locations

CONFIDENTIAL — DO NOT DISTRIBUTE

- v). Communications Equipment
 - (1) Communications equipment for the kitchen area are described below; and detailed information regarding communications equipment can be found in Chapter 14, Communications.
 - (2) PA Speakers
 - (a) PA speakers shall be located on the ceiling panels at both ends of the kitchen.
 - (b) The speakers used in this location shall be identical to PA speakers used in other locations in the trainset for ease of maintenance and replacement.
 - (3) PA Intercom
 - (a) PA Intercom shall be mounted near the stairs and the side loading door of the kitchen area.
 - (b) This intercom shall be identical to the PA intercom used in other locations in the trainset for ease of maintenance and replacement.
 - (4) Security Cameras
 - (a) Security Cameras shall be mounted to ceiling panels and shall give surveillance view of all areas of the kitchen for security, theft protection, and identification of possible hazards.
 - (b) At least 4 cameras shall be used to achieve this goal.
 - (5) POS Ticket Display Screen
 - (a) POS Ticket Display Screen shall be mounted near the Food Service Lift and the steam/induction table.
 - (b) This screen shall be wired to communicate with the POS and display ticket items for plating and delivery to customers in the diner.
 - (c) The screen shall be 32" and more information can be found in Chapter 11: Interiors, Chapter 14, and Chapter 26 in regard to this display.
 - (d) The screen shall be resistant to damage from steam and humidity within the kitchen area.
 - (6) Smoke Detectors
 - (a) Smoke Detectors shall be mounted on the ceiling panels at both ends of the kitchen.

- (b) The smoke detectors used in this location shall be identical to the smoke detectors used in other locations in the trainset for ease of maintenance and replacement.

vi). Emergency Equipment

- (1) The following emergency equipment pieces shall be included and stored in a conspicuous, accessible, and labeled location. Please refer to Chapter 18 Emergency Equipment for more information.
 - (a) Snap lights
 - (b) First aid kit
 - (c) Fire extinguisher
 - (d) AED
 - (e) Fire Suppression System shall be provided as an option and is discussed in detail in Chapter 25.

vii). Security

- (1) Many items within the food service area will need to be secured. The following items are identified with specific locking preferences. Any other locking or security items will be discussed with Amtrak during design reviews.
 - (a) Cart Locking
 - (i) The cart storage compartments shall include mechanisms that will lock the carts in the compartment as well as prevent the cart door from opening.
 - (ii) The locking mechanism shall use an Amtrak supplied padlock to secure the carriers.
 - (b) Cabinet Locking
 - (i) Cabinets shall include padlock hasps as determined with Amtrak during design reviews.
 - (ii) The locking mechanism shall use an Amtrak supplied padlock to secure the selected cabinets.
 - (c) Carrier Locking
 - (i) The carrier storage compartments shall include mechanisms that will lock the carriers in the compartment as well as prevent the carrier door from opening.
 - (ii) The locking mechanism shall use an Amtrak supplied padlock to secure the carriers.

- (d) Refrigeration Cabinet Locking
 - (i) Refrigeration cabinets shall include padlock hasps as determined with Amtrak during design reviews.
 - (ii) The locking mechanism shall use an Amtrak supplied padlock to secure the selected cabinets.
- (e) Freezer Locking
 - (i) The freezer shall include padlock hasps as determined with Amtrak during design reviews.
 - (ii) The locking mechanism shall use an Amtrak supplied padlock to secure the selected cabinets.
- viii). Color Material and Finish (CMF)
 - (1) Please refer to the attached CMF document for exact color, material, and finishes desired in this food service area.
 - (2) Please also refer to Materials and Workmanship in Chapter 19.
 - (3) General expectations are listed below.
 - (a) Stainless Steel Modules
 - (i) Stainless Steel Modules shall be created from sheet metal that is sized to prevent denting, oil canning, or otherwise non-sturdy structures.
 - (ii) The modules shall be constructed from 304 stainless-steel with a #4 finish (320 grit) or as approved during design reviews with Amtrak.
 - (b) Carshell Walls
 - (i) Carshell walls shall be lined to create interior walls for the kitchen. Sidewall liners shall be made from molded thermoplastic with an easy to clean surface finish.
 - (c) Partition Walls
 - (i) Partition Walls shall be created from a composite structure such as aluminum honeycomb or HPL skinned honeycomb panels.
 - (ii) The finish of the wall and material of the outside skin shall be inspired by the CMF document and meet all structural requirements for crashworthiness based on mounting and attached loads to the panel.
 - (d) Ceiling Panels

- (i) Ceiling Panels shall be created from a composite structure such as aluminum honeycomb or HPL skinned honeycomb panels.
 - (ii) The finish of the passenger facing side of the ceiling panel and material of the outside skin shall be inspired by the CMF document and meet all structural requirements for crashworthiness based on mounting and attached loads to the panel.
 - (iii) The finish of the material on the non-passenger facing side shall be coated such that there is no risk of corrosion from moisture from steam or humidity within the car.
- (e) Kitchen Area Countertops
- (i) Countertops within the kitchen area shall all be made from stainless-steel and shall follow the requirements from point (1) above.
- (f) Kitchen Area Flooring
- (i) Flooring within the kitchen area shall be made from rubber flooring with a friction, no-slip texture.
 - (ii) Flooring will be durable to withstand spills, leaks, and all methods of cleaning.
 - (iii) Flooring shall also not become frequently damaged or worn by cart movement or by kitchen staff standing in specific locations.
 - (iv) Flooring shall have enough flexibility to prevent fatigue from standing.
 - (v) Anti-fatigue mats and anti-slip mats shall be provided for onboard crew in all applicable areas.

16.5 Servery

a). Vision

- i). The Servery should be designed to complement the ambiance of the dining car as a whole, adding to the sense of occasion which accompanies dining on Amtrak Long Distance.
- ii). The exterior of the Servery must convey the ambiance and aesthetics that are synonymous of a premium first-class service.
- iii). The Servery should be designed to deliver a premium at-seat service and provide a suitable platform to facilitate an in room dining experience via a trolley service.

- iv). The Servery should be pleasant space to work.
 - v). The arrangement of the Servery and Servery equipment should be safe, practical, and ergonomic with a layout that promotes operational efficiencies.
 - vi). The design of the back of house should be future ready:
 - (1) The design of this area should be considered as modular so that equipment can be upgraded or changed as service models evolve over time.
 - vii). A space should be reserved on the outside wall of the Servery for branding.
 - viii). The Servery should have a semi open architecture to accomplish the following:
 - (1) 'Back of House' activities such as final staging and plating up for diner service, clearing dirty dishes, waste disposal etc. should be hidden from the direct view of the passengers in the diner, so as not to disturb their dining experience.
 - (2) High lux lighting used within the Servery for food preparation should be contained or be shielded from the main dining car, so bright light does not spill into the dining space, disturbing the atmosphere of the dining car.
 - (3) Lines of sight and access to and from the Servery should remain open for Amtrak staff to effectively manage the Dining car and serve passengers.
 - (4) Crew flow in and out of the diner should be free and clear with more than one entry and exit point available.
 - (5) The Architecture of the Servery should allow diners to approach staff, catch the attention of the crew, or process payments while they work in the Servery area.
 - ix). A clear delineation should be made between crew area and passenger areas – so crew are not disturbed as they work, and passengers do not stray into the Servery area.
- b). Desired Layout
- i). The layout in the figures below shows the desired approximate locations and relative footprints for each element of the Servery from an ergonomic and preparation flow perspective.
 - (1) The Contractor shall use this layout as the basis for the Servery design and make adjustments as necessary to provide complete functionality.
 - (2) The final layouts will be approved by Amtrak during the design review process.

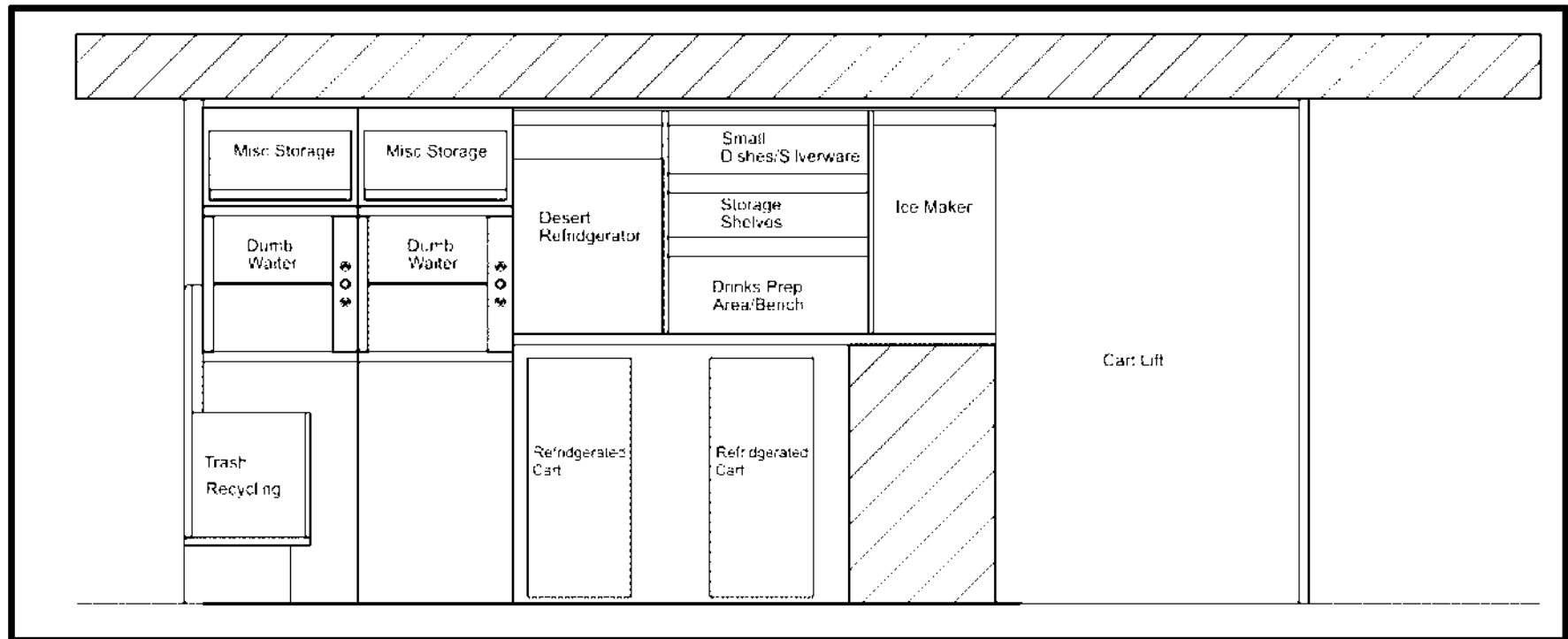

Figure 16-6: Servery Layout- Carshell Wall Elevation

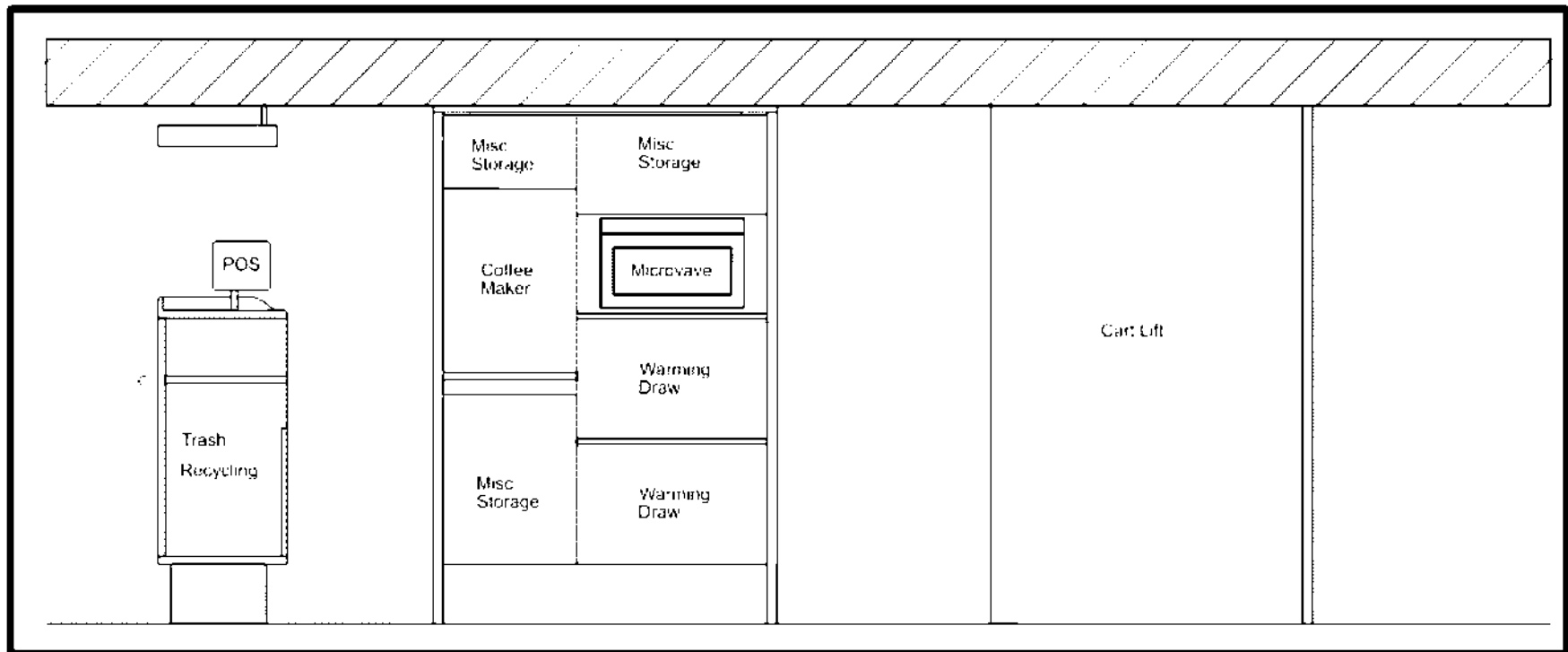

Figure 16-7: Servery Layout- Elevation Passenger Aisle

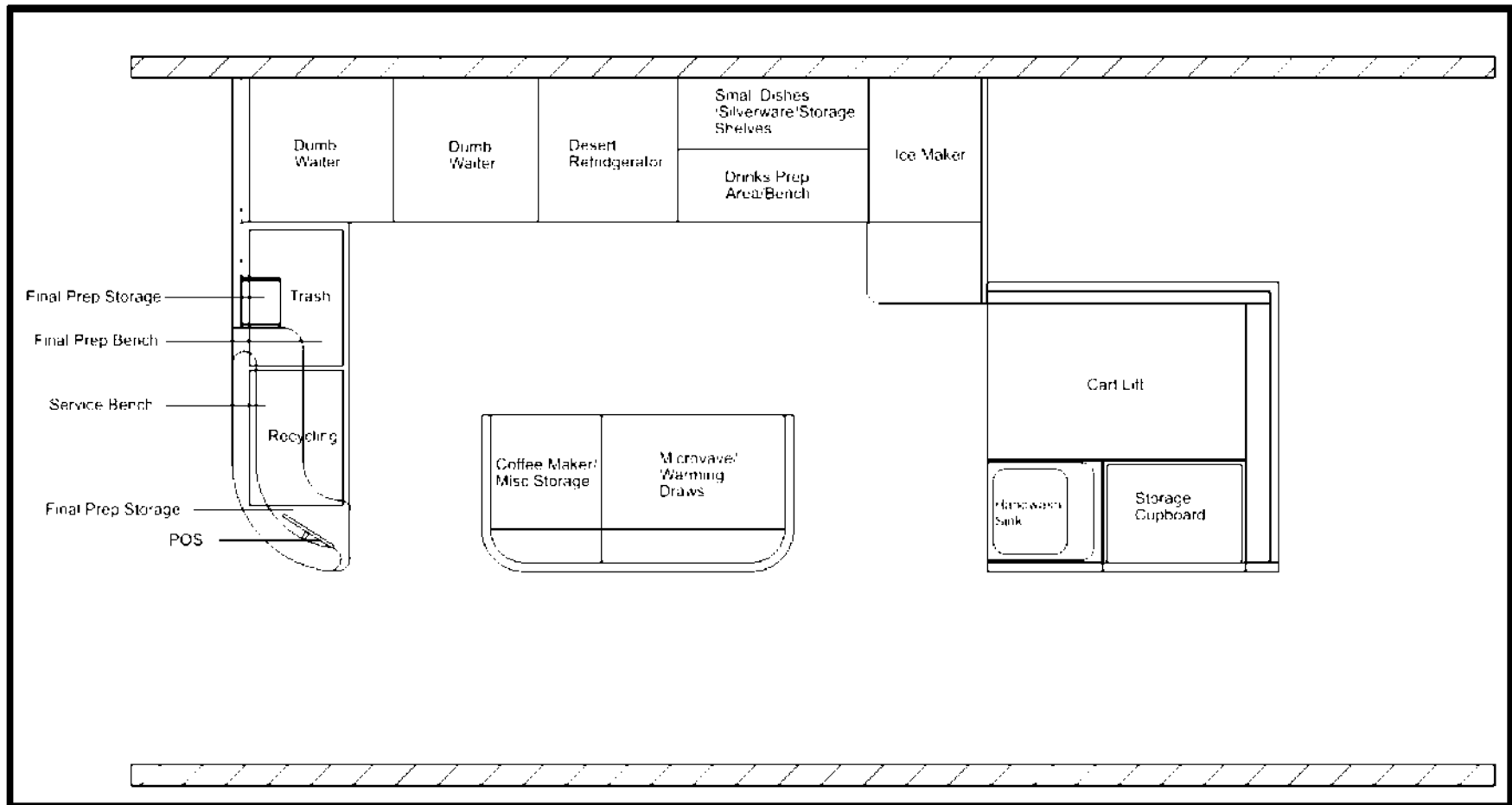

Figure 16-8: Servery Layout- Top View

c). Appliances

- i). Figure 16-9 lists the desired appliances along with an example part number and the quantity required within the Servery food service area.
 - (1) Example part numbers are given to establish a starting place for appliance performance and will be finalized during the design reviews.
 - (2) The car builder will propose the exact manufacturer and part number for each appliance based on functionality, shock and vibration, service history, power requirements, and ability to meet crashworthiness requirements for mounting.
- ii). Detailed functional requirements for each appliance is listed below.
- iii). In addition to these requirements, the Contractor shall factor in FDA cleaning clearances, radii, and sanitary design.
 - (1) Cart Lift
 - (a) The cart lift in the servery is linked to the cart lift in the kitchen and shall therefore meet the same descriptive requirements listed in section 16.4.
 - (b) Cart lifts shall be outfitted with overweight sensing devices to mitigate the risk of overloading the lifting mechanisms and taking the device out of service.
 - (i) Overloading mechanisms shall be sized according to the maximum amount of available weight with a safety factor to offset overweight sensing.
 - (c) Cart lifts shall have a positioning system, either by motor encoder or proximity switches, that will allow the controller to recover from loss of power and manual mode operations.
 - (d) There shall be a small status panel hidden from passenger view adjacent to the cart lift control panel.
 - (e) The status panel shall have either a display or a row of health status LEDs for each interlock that is required to operate the Food Service Lift.
 - (f) Cart lifts shall communicate with the onboard CDU to communicate errors and faults for quick diagnosis with the onboard crew.
 - (g) The controller and status panel shall include at a minimum, the following interlock statuses:
 - (i) "upper doorway closed",
 - (ii) "lower doorway closed",

Figure 16-9: Appliance List - Servery

Appliance	Description	Example Part Number	Quantity Desired
Cart Lift	This is a lift system for the refrigerated carts to move between levels of the bilevel car.	NOTE LINKED TO KITCHEN	1
Refrigerated Cart Docking Station (2 cart)	2 cart docking station with cart chiller, cart sensor, temperature monitoring,	Stahl L002923	1
Refrigerated Cart	Insulated food cart with capability to maintain food temperature of 40 degrees F for one hour after loss of power	Bucher BA700036	2
Handwashing Sink	Sink basin with IR faucet for handwashing purposes, includes soap dispenser and paper towel holder mounting	-	1
Trash and recycling Storage	Stainless steel module for storing removable trash and recycling bin. Trash and recycling bin is accessible through a drawer.	-	1
Food Service Lifts	This is a lift system for plated food and/or dirty dishes to move between levels of the bilevel car.	NOTE LINKED TO KITCHEN	2
POS	Point of Sale machine for commercial transactions.	POS provided by Amtrak, provisions provided by Contractor	1
Warming Drawers	Insulated warming drawer with ability to keep food goods between 60 and 200 degrees F.	-	1
Storage Cabinets	Stainless steel cabinets or open shelving for dry storage to maximize space usage within food service area.	-	As space allows
Refrigerated Cabinets	Insulated refrigerator cabinet with ability to keep food goods between 32 and 40 degrees F	-	1
Countertop Workspace	Clear available workspace for food preparation with 6" backsplash and 0.25" radii.	-	As space allows
Coffee Maker	Twin coffee brewer with 1.5 gallon satellite servers,	Wilbur Curtis GEMTS16A-1000	1
Ice Maker	590 lb., 26" wide water cooled, cublet-nugget style ice machine and waster dispenser with bin, countertop mounting, 40lb bin ice storage	Hoshizaki DCM-500BWH	1

- (i) "weight sensor",
 - (ii) "motor ok",
 - (iii) "adjustment ok",
 - (iv) "manual override",
 - (v) "manual cut-out".
- (h) The cart lift controller shall monitor motor current and report preventative maintenance alerts and faults to the car diagnostic system.
- (i) The cart lift controller shall record each failed attempts to operate the cart lift and include a snapshot of all interlocking signals with each failed attempt.
- (i) The data shall be available to maintenance for trend analysis and training.
- (2) Refrigerated Docking Station
- (a) All features for the refrigerated docking station shall be identical to the refrigerated docking station described in the kitchen section 16.4.
- (3) Refrigerated Cart
- (a) All features for the refrigerated cart shall be identical to the refrigerated cart described in the kitchen section 16.4.
- (4) Handwashing Sink
- (a) All features for the handwashing sink shall be identical to the handwashing sink described in the kitchen section 16.4.
 - (b) This includes faucet, soap dispenser, and paper towel holder.
- (5) Trash and Recycling Storage
- (a) All features for the trash and recycling storage shall be identical to the trash and recycling storage described in the kitchen section 16.4.
 - (b) This includes the features for the trash and recycling bin.
 - (c) With the following exception: In this food service area, the cumulative minimum internal volume for the trash and recycling storage required is: 24 cu ft.

- (6) Food Service Lifts
 - (a) The Food Service Lifts in the servery is linked to the Food Service Lifts in the kitchen and shall therefore meet the same descriptive requirements listed in section 16.4.
 - (b) Food Service Lifts shall be outfitted with overweight sensing devices to mitigate the risk of overloading the lifting mechanisms and taking the device out of service.
 - (i) Overloading mechanisms shall be sized according to the maximum amount of available weight with a safety factor to offset overweight sensing.
 - (c) Food Service Lifts shall have a positioning system, either by motor encoder or proximity switches, that will allow the controller to recover from loss of power and manual mode operations.
 - (d) There shall be a small status panel hidden from passenger view adjacent to the Food Service Lift control panel.
 - (e) The status panel shall have either a display or a row of health status LEDs for each interlock that is required to operate the Food Service Lift.
 - (f) Food Service Lifts shall communicate with the onboard CDU to communicate errors and faults for quick diagnosis with the onboard crew.
 - (g) The controller and status panel shall include at a minimum, the following interlock statuses: “upper doorway closed”, “lower doorway closed”, “weight sensor”, “motor ok”, “adjustment ok”, “manual override”, “manual cut-out”.
 - (h) The Food Service Lift controller shall monitor motor current and report preventative maintenance alerts and faults to the car diagnostic system.
 - (i) The Food Service Lift controller shall record each failed attempts to operate the Food Service Lift, and include a snapshot of all interlocking signals with each failed attempt. The data shall be available to maintenance for trend analysis and training.
- (7) Point-of-Sale (POS)
 - (a) A Point-of-Sale unit will be provided by Amtrak in the food service area.
 - (b) The POS unit will be manufactured and installed in accordance with Amtrak POS standards in effect at the time of design and manufacture of the trainset.

- (c) The POS operation shall be supported during Head End Power (HEP) outages according to the Table 15-3 Power Phase Matrix battery table.
- (d) The system shall also support real time inventory management of on-board food service items.
 - (i) Shortages shall be annunciated to onboard crew as well as transmitted wayside for mitigation by Amtrak Food and Beverage Services.
 - (ii) Details of the wayside messaging shall be clarified during mobilization.
- (e) The Contractor shall provide monthly electronic reports detailing all on-board POS purchases.
 - (i) These reports shall be searchable by all relevant criteria to all Amtrak to fine tune its food and beverage service.
- (8) Point of Sale System (Option)
 - (a) As an option, the carbuilder shall submit an option to provide a point of sale system as part of this contract.
 - (b) A Point of Sale (POS) system is a specialized computerized system that facilitates the processing and completion of retail transactions. It serves as the central hub where passengers make a payment for goods on-board the train.
 - (c) Hardware
 - (i) Terminal/Checkout Counter: This is the physical location where the POS system is set up. It includes a computer terminal with a display, a barcode scanner, receipt printer, and a customer-facing display.
 - (ii) Barcode Scanner: Used to scan the barcodes on products, providing quick and accurate identification.
 - (iii) Card Reader: Allows customers to make electronic payments using credit or debit cards.
 - (iv) Cash Drawer: Safely stores cash received during transactions.
 - (v) Receipt Printer: Prints transaction receipts for customers.
 - (vi) Customer Display: A screen facing the customer that displays the items being rung up and the total cost.

- (d) Software
 - (i) Point of Sale Application: The core software that manages and processes transactions. It includes a user interface for the crew to input items, calculate totals, and finalize sales.
 - (ii) Inventory Management: Tracks the quantity of products available for sale and updates inventory levels after each transaction.
 - (iii) Sales Reporting: Generates reports on sales, inventory, and other key metrics.
 - (iv) Employee Management: Manages user accounts and permissions.
 - (v) Payment Processing Integration: Links with payment gateways to process electronic transactions securely.
 - (vi) Security Features: Includes measures like user authentication, transaction encryption, and audit trails to ensure data security and integrity.
- (9) Warming Drawer
 - (a) All features for the warming drawer shall be identical to the warming drawer described in the kitchen section 16.4.
 - (b) In this food service area, the cumulative minimum internal volume for the warming drawer required is 7.3 cu ft. (44 in horizontal x 12 in tall x 24 in deep).
- (10) Storage Cabinet
 - (a) All features for the storage cabinet shall be identical to the storage cabinet described in the kitchen section 16.4.
 - (b) In this food service area, the cumulative minimum internal volume for the storage required is: 32 cu ft.
 - (i) 8 cu ft. (40 in horizontal x 32 in tall x 11 in deep).
 - (ii) Plus 20.8 cu ft (90 in horizontal x 20 in tall x 20 in deep).
 - (iii) Plus 3.5 cu ft (15 in horizontal x 20 in tall x 20 in deep)
- (11) Refrigerated Cabinet
 - (a) All features for the refrigerated cabinet shall be identical to the refrigerated cabinet described in the kitchen section 16.4, with the following exceptions:

- (i) In this food service area, the cumulative minimum internal volume for the refrigerated cabinets required is 2.875 cu ft. (23 in horizontal x 27 in tall x 8 in deep).
 - (ii) Safety glass clear doors shall be used for this refrigerated cabinet as it may be used as a display or to see the number of desserts stored in the servery.
 - (iii) In addition to the safety glass clear doors, lighting shall be included to illuminate the items inside the display.
 - (iv) Shelving shall be static and spaced 12 inches apart to create space for 8 cakes.
- (12) Countertop Workspace
- (a) All features for the countertop workspace shall be identical to the countertop workspace described in the kitchen section 16.4, with the following exception:
 - (i) In this food service area, the minimum surface area for workspace required is 7.5 sq ft. (90 in horizontal x 12 in deep).
- (13) Coffee Maker
- (a) A purchased off the shelf item shall be provided that meets or exceeds the features from the example part number. Example part number listed as Wilbur Curtis GEMTS16A-1000.
 - (i) Twin coffee brewer
 - (ii) 1.5 gallon satellite servers,
 - (iii) A spare coffee maker shall be provided in storage in the event of failure
 - (iv) All coffee maker drains shall have the capacity to drain both warmers without overflowing or splashing liquid onto the counter.
- (14) Ice Maker
- (a) A purchased off the shelf item shall be provided that meets or exceeds the features from the example part number. Example part number listed as Hoshizaki DCM-500BWH.
 - (i) 590 lb. production capacity in 24 hour period
 - (ii) 26" wide
 - (iii) water cooled, cublet-nugget style ice machine

- (iv) waster dispenser
 - (v) countertop mounting,
 - (vi) 40lb bin ice storage
- d). Functional Criteria
- i). The following items shall be reviewed with the criteria listed below for each.
 - ii). Sanitary Design Review Criteria
 - (1) Appropriate cleaning radii of at least 0.25" on worksurfaces and 0.75" on sink areas.
 - (2) Backsplashes of at least 6" on worksurfaces and sink areas.
 - (3) Appropriate cleaning clearances around appliances such that a 95th percentile male can fit their hand and a rag easily between objects for cleaning.
 - (4) All edges and seams are sealed with food grade silicone sealant and gaps greater than 1/32" are sealed in food storage, food preparation, and all other food related areas such as trash compartments shall be sealed in this manner.
 - (5) Floor drains are provided for locations prone to spills and leaks, especially near water piping to eliminate pooling water on the floor.
 - (6) Openings are protected from allowing pests and vermin to congregate
 - (7) Proper sealing methods are used to prevent moisture from corroding or otherwise damaging the food service area
 - (8) All drain pans and catches are accessible for cleaning
 - (9) No tools are required to move objects subject to daily cleaning rituals
 - iii). Refrigeration and Freezer Equipment Review Criteria
 - (1) Temperature Monitoring System Functionality
 - (a) Temperature monitoring shall be accomplished through a set of redundant sensors.
 - (i) The refrigeration controller shall relay temperatures for each of the refrigerated modules locally and in one location on a panel in the kitchen.
 - (b) Additionally, temperatures shall be reported to wayside through the use of a PT100 sensor.

- (i) The PT100 sensor and the controllers for the equipment shall be calibrated to ensure they are reporting the same temperature.
 - (ii) Temperatures shall be logged and accessible for at least a 6 month period of time after the date of data collection.
 - (c) Temperatures for the refrigerated food carts shall be monitored in the ducting between the refrigerated docking station and the refrigerated cart.
 - (i) Industry standard is to monitor the temperature and combine 80% of the temperature for the return air and 20% for the supply air.
 - (ii) This calculation shall be used to determine the likely warmest temperature of the air in the food cart and shall inform the setpoint and need for temperature adjustment.
 - (d) Temperatures for refrigerated cabinets shall be monitored directly in the refrigeration cabinet at the warmest temperature location and shall inform the setpoint and need for temperature adjustment.
 - (e) Presently, Amtrak monitors the temperature of a refrigerated food cart by placing a yoghurt in the center of the cart and manually records the temperature of the yoghurt on an interval. If the yoghurt is out of temperature the food in the cart is considered out of temperature and therefore spoiled. The Contractor shall provide a system that consistently functions without allowing the yoghurt to test out of temperature and cause loss of revenue from spoiled goods.
- (2) Type Tests
 - (a) Type Tests for refrigeration and freezer systems shall be evaluated using ISO 23953-2 to determine the temperature probe location and validate performance of the system and produce a test report for Amtrak's evaluation and approval as specified in ISO 23953-2 **[CDRL 16-03]**:
 - (b) The following elements of design validation are of particular interest to Amtrak and shall be performed as type tests if information is not included in the ISO 23953-2 test report:
 - (i) Operational Temperature
 1. The system shall maintain food safe temperatures between 33°F to 40°F (1°C to 4°C) consistently for 8 hours.
 2. The freezer module will need to maintain

temperature ranges below 0°F (-18°C) consistently for 8 hours.

3. The supplier will propose a test to show the units maintain operational temperature under standard conditions:
 - a. 74.6°F (23.7°C) and 55% rH.
 - b. An allowable tolerance to this would be +/- 2 degrees F and +/- 5%.
4. The refrigeration systems shall be suitably insulated to maintain the specified temperature limits during a power loss of 60 minutes to avoid condemning of perishable food products.
5. The refrigeration system shall have real-time and remote temperature monitoring and alarm annunciation capabilities that shall alert onboard crew.
6. The Contractor shall propose a test to show the units maintain operational temperature under standard conditions:
 - a. 74.6°F (23.7°C) and 55% rH.
 - b. An allowable tolerance to this would be +/- 2 degrees F and +/- 5%.

(ii) Probe Placement

1. The temperature probe will need to be placed in the warmest location of the refrigerated compartment so that all food items stay within the acceptable temperature range.

(iii) Air Flow

1. The air flow through the module will need to be evaluated to ensure that there are no warm air pockets within the refrigerated compartment.

(iv) Operational Load Testing

1. The operational load of the refrigeration module needs to be evaluated to ensure that the refrigeration unit functions within the acceptable temperature range with simulated service loading conditions.
2. Amtrak will provide loading conditions prior to test procedure approval.

3. Three total tests will satisfy the operational load requirement: full load, half load, empty load. The operational temperature of the refrigeration system should maintain food safe temperatures.
 4. The refrigeration module will need to maintain temperature ranges between 33°F to 40°F (1°C to 4°C) consistently for 8 hours.
 5. The freezer module will need to maintain temperature ranges below 0°F (-18°C) consistently for 8 hours.
 6. The Contractor shall propose a test to show the units maintain operational temperature under standard conditions:
 - a. 74.6°F (23.7°C) and 55% rH.
 - b. An allowable tolerance to this would be +/- 2 degrees F and +/- 5%.
- (v) Condensation Evaluation
1. The refrigeration module, freezer, and chilled cart modules shall function with zero condensation on the outside surface of a module when exposed to the following environmental conditions:
 - a. 74.6°F (23.7°C) and 55% rH.
 - b. An allowable tolerance to this would be +/- 2 degrees F and +/- 5%.
 - c. Zero condensation is defined as no fogging, beading, or dripping liquid on any outside surface of the module.
 2. The Contractor shall perform a test to observe modules while they are functioning at the specified temperatures for 8 hours.
- (vi) Pull Down
1. The refrigeration and freezer modules are expected to pull down to temperature within 90 min with an inlet temperature of 70°F and repeated with inlet temperature of 110°F.
 2. The module will be completely empty for this test. The refrigeration unit shall reach a temperature range of 33-40°F within the specified time.

3. The freezer unit shall reach a temperature of below 0°F within the specified time.
- iv). Warming Equipment
- (1) Type Tests for warming equipment shall be evaluated using DIN 18868-2 to determine the temperature probe location and validate performance of the system and produce a test report for Amtrak's evaluation and approval as specified in DIN 18868-2 **[CDRL 16-04]**
- e). Additional Equipment Requirements
- i). HVAC
- (1) Food service areas generate a large amount of ambient heat, smells, and humidity in the air; as a result, the HVAC system calculations must take into account the appliances and usage case of each food service area. Detailed HVAC requirement information can be found in Chapter 10, HVAC System.
 - (2) Servery Area Ventilation
 - (a) Ventilation to area in the Servery shall include appliance generation of large amount of ambient heat, smells, and humidity in the air.
 - (b) The contribution of the Servery to the heat load in the rest of the dining car shall be evaluated.
 - (3) Appliance-Specific Ventilation
 - (a) Ventilation to specific appliances is required.
 - (b) This ventilation can come in the form of recycled air through the HVAC system or directly exhausting the outlet air for an appliance.
 - (c) The Contractor shall submit a proposal for which appliances listed below will be directly exhausted and provide all relevant calculations as justification.
 - (d) The submittal will be subject to Amtrak's review and approval during the design review process. **[CDRL 16-05]**
 - (i) Refrigeration
 1. Refrigerated Docking Station
 2. Refrigerated Storage
 - (ii) Other Appliances
 1. Coffee Maker

2. Ice Maker

ii). Electrical Equipment

- (1) Electrical equipment information is shared in the points below. Detailed electrical requirements can be found in Chapter 15, Electrical System.
- (2) Convenience Outlets
 - (a) Convenience Outlets shall be located during design reviews after discussion and approval from Amtrak.
 - (b) At least 4 duplex convenience outlets shall be located within the servery food service area.
 - (c) Only the convenience outlet near the attendant seat shall have USB ports.
 - (d) General purpose convenience outlets in these areas shall not have USB ports.
- (3) Appliance Outlets
 - (a) Appliance Outlets shall be located directly behind a desired appliance.
 - (b) The outlets shall be properly sized and selected to safely power each appliance and the electrical system shall provide a dedicated breaker for each type of outlet.
 - (c) Appliance outlets shall not have USB ports.
- (4) POS Ticket Screen Outlet
 - (a) POS Ticket Screen Outlet shall be linked to the POS in the kitchen with both communications cabling and share the same electrical circuit and dedicated breaker as the POS.
 - (b) The POS outlet shall have USB ports.
 - (c) The POS outlet must be available on car battery power and follow the battery load table 15-3: Power Phase Matrix.

iii). Lighting

- (1) Lighting general information is shared in the points below. Detailed lighting information can be found in Chapter 13, Lighting System.
- (2) The points below are accompanied with diagram to show approximate lighting locations and types.

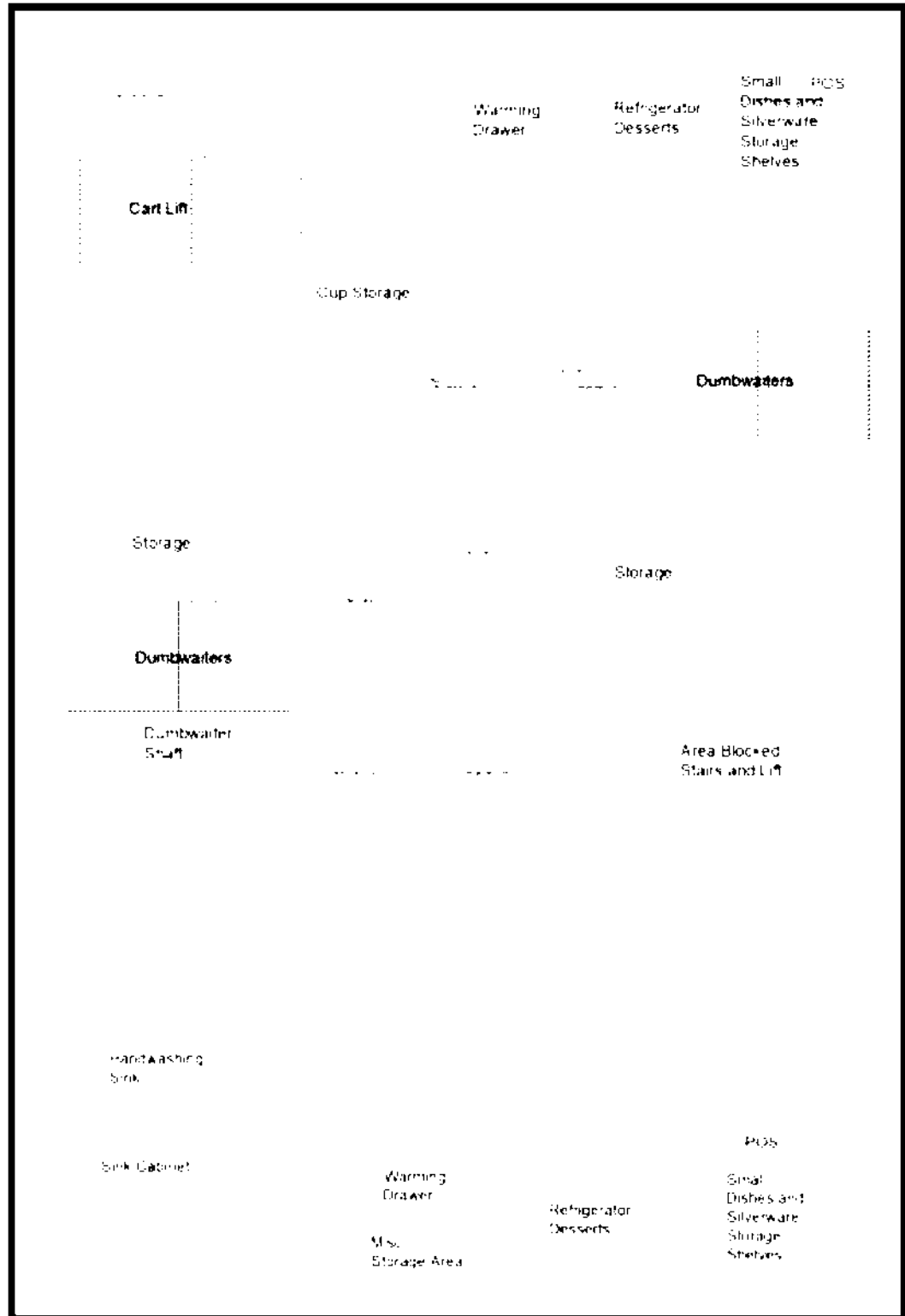

Figure 16-10: Servery Layout - Overhead and Strip Light General Locations



Figure 16-11: Servery Layout - Display Case Lighting

- (3) Overhead Lighting
 - (a) Overhead lighting shall be from flush mounted panel lights in the ceiling panels and/or from spotlights.
 - (b) Overhead lighting can be turned off if the car lighting mode is set to night mode.
 - (c) These overhead light fixtures cannot be required to meet FDA light intensity level requirements for food preparation counters, sinks, and workspaces.
- (4) Shelf Lighting
 - (a) Shelf lighting will be from surface mounted strip lights.
 - (b) These strip lights will be different brightness levels based on the area they are illuminating.
 - (c) Shelf lighting alone shall be the main source of illumination to meet FDA light intensity level requirements for food preparation counters, sinks, and workspaces.
 - (d) To illuminate a shelf, the shelf or underside of the top of the module above the shelf shall have a strip light mounted.
 - (e) To illuminate a workspace, the underside of the shelf above the workspace shall have a strip light mounted.

- (1) Display Case Lighting
 - (a) Display case lighting shall be lit from the sides of the display case and angle inward to illuminate the product inside of the display case.
 - (2) Ambiance Lighting
 - (a) Ambiance lighting shall be provided to Amtrak where applicable. Ambiance lighting is shown in the CMF documents.
- iv). Communications Equipment
- (1) Communications equipment for the Servery are described below.
 - (2) Detailed information regarding communications equipment can be found in Chapter 14, Communications.
 - (3) PA Speaker
 - (a) PA speakers shall be located on the central ceiling panel for the Servery.
 - (b) The speakers used in this location shall be identical to PA speakers used in other locations in the trainset for ease of maintenance and replacement.
 - (4) PA Intercom
 - (a) PA Intercom shall be mounted near the handwashing sink in the Servery.
 - (b) This intercom shall be identical to the PA intercom used in other locations in the trainset for ease of maintenance and replacement.
 - (5) Security Cameras
 - (a) Security Cameras shall be mounted to ceiling panels and shall give surveillance view of all areas of the Servery for security, theft protection, and identification of possible hazards.
 - (b) At least 2 cameras shall be used to achieve this goal.
 - (6) Smoke Detectors
 - (a) Smoke Detectors shall be mounted on the central ceiling panel of the Servery.
 - (b) The smoke detectors used in this location shall be identical to the smoke detectors used in other locations in the trainset for ease of maintenance and replacement.

v). Emergency Equipment

- (1) The following emergency equipment pieces shall be included and stored in a conspicuous, accessible, and labeled location. Please refer to Chapter 18 Emergency Equipment for more information.
 - (a) Snap lights
 - (b) First aid kit
 - (c) Fire extinguisher
 - (d) AED

vi). Security

- (1) Many items within the food service area will need to be secured. The following items are identified with specific locking preferences. Any other locking or security items will be discussed with Amtrak during design reviews.
 - (a) Cart Locking
 - (i) The cart storage compartments shall include mechanisms that will lock the carts in the compartment as well as prevent the cart door from opening.
 - (ii) The locking mechanism shall use an Amtrak supplied padlock to secure the carriers.
 - (b) Cabinet Locking
 - (i) Cabinets shall include padlock hasps as determined with Amtrak during design reviews.
 - (ii) The locking mechanism shall use an Amtrak supplied padlock to secure the selected cabinets.
 - (c) Carrier Locking
 - (i) The carrier storage compartments shall include mechanisms that will lock the carriers in the compartment as well as prevent the carrier door from opening.
 - (ii) The locking mechanism shall use an Amtrak supplied padlock to secure the carriers.
 - (d) Refrigeration Cabinet Locking
 - (i) Refrigeration cabinets shall include padlock hasps as determined with Amtrak during design reviews.

- (ii) The locking mechanism shall use an Amtrak supplied padlock to secure the selected cabinets.
- vii). Countertop Heights
 - (1) Countertop at point of sale shall be 42" maximum.
- viii). Color Material and Finish (CMF)
 - (1) Please refer to the attached CMF document for exact color, material, and finishes desired in this food service area.
 - (2) Please also refer to Materials and Workmanship in Chapter 19. General expectations are listed below.
 - (3) CMF will be finalized with Amtrak after the mockup review.
 - (4) Stainless Steel Modules
 - (a) Stainless Steel Modules shall be created from sheet metal that is sized to prevent denting, oil canning, or otherwise non-sturdy structures.
 - (b) The modules shall be constructed from 304 stainless-steel with a #4 finish (320 grit) or as approved during design reviews with Amtrak.
 - (5) Carshell Walls
 - (a) Carshell walls shall be lined to create an interior wall for the servery. Sidewall liners shall be made from molded thermoplastic with an easy to clean surface finish.
 - (6) Partition Walls
 - (a) Partition Walls shall be created from a composite structure such as aluminum honeycomb or HPL skinned honeycomb panels.
 - (b) The finish of the wall and material of the outside skin shall be inspired by the CMF document and meet all structural requirements for crashworthiness based on mounting and attached loads to the panel.
 - (7) Ceiling Panels
 - (a) Ceiling Panels shall be created from a composite structure such as aluminum honeycomb or HPL skinned honeycomb panels.
 - (b) The finish of the passenger facing side of the ceiling panel and material of the outside skin shall be inspired by the CMF document and meet all structural requirements for crashworthiness based on mounting and attached loads to the panel.

- (c) The finish of the material on the non-passenger facing side shall be coated such that there is no risk of corrosion from moisture from steam or humidity within the car.
- (8) Servery Area Countertops
 - (a) Countertops within the servery area shall all be made from stainless-steel and shall follow the requirements from point (1) above.
- (9) Servery Area Flooring
 - (a) Flooring within the servery area shall be made from rubber flooring with a friction, no-slip texture.
 - (b) Flooring will be durable to withstand spills, leaks, and all methods of cleaning.
 - (c) Flooring shall also not become frequently damaged or worn by cart movement or by kitchen staff standing in specific locations.
 - (d) Flooring shall have enough give to prevent fatigue from standing.

16.6 First Class Lounge Bar

a). Vision

- i). The bar is the social epicenter of the train for First Class Passengers, providing a chance to meet other passengers over drinks and snacks while taking in the views. In its external look, it should speak to the historical romance of rail travel, with a grand classically inspired architecture, while also having contemporary details to ensure a more future facing aesthetic. The bar must convey the ambiance and aesthetics that are synonymous of a premium first-class service.
- ii). The bar space has a dual purpose within the lounge:
 - (1) During the morning it has a self-service coffee and refreshments area
 - (2) Later in the day it becomes a traditional, staffed bar.
- iii). The self-service area should be fully accessible for all passengers including people using wheeled mobility devices.
 - (1) This area should serve coffee, water/ice and have a soft drinks fridge.
- iv). There should be an area on the bar where Amtrak can lay out light fare offerings in the morning and afternoons.
- v). The bar is primarily an evening space and should be fully equipped to serve beer, wine, champagne, cocktails, soft drinks and coffee.

- vi). Dry storage should be allowed for to support light fare served in the evening as well as a staging area and cold storage for other snacks pre-prepared in the Kitchen.
 - vii). In addition to the experiential element, the bar's intention is to help generate new revenue opportunities for Amtrak. The display of liquor and glassware should be dramatic, with lit bottles and premium finishes that create a standout merchandising display. The bar must be in line of sight from the lounge seating area.
 - viii). Passengers should be able to stand and order at the at the bar, but the bar design should also be equipped to deliver at-seat service to lounge customers with an easy entry to and from the back of the bar and a pick-up zone for drinks ready to go out for service.
 - ix). The bar will not be staffed 24 hours a day which requires a way to lockdown the bar during unstaffed hours. (The self-service parts of the bar remaining open and accessible). Even when shut down the bar should still have a premium feel with a tidy and aesthetically pleasing closed state.
 - x). Glassware and bottles on display should be securely stowed to prevent rattling and prevent any risks or hazards to crew or passengers.
 - xi). Lighting will play a key part to the bar's success and a signature lighting element should be designed to set the ambiance and add a premium touch.
 - xii). All design details should be commensurate with the design vision and overall ambiance of the lounge car.
 - xiii). The back of bar should be pleasant space to work.
 - (1) The arrangement of the bar and bar equipment should be safe, practical, and ergonomic with a layout that delivers operational efficiencies.
 - xiv). A space should be reserved on the outside wall of the Bar for branding.
 - xv). The design of the back of house should be future ready – The design of this area should be considered as modular so that equipment can be upgraded or changed as service models evolve over time.
- b). Desired Layout
- i). The layout in the figures below shows the desired approximate locations and relative footprints for each element of the first class bar from an ergonomic and preparation flow perspective.
 - (1) The Contractor shall use this layout as the basis for the first class bar design and make adjustments as necessary to provide complete functionality.
 - (2) The final layouts will be approved by Amtrak during the design review process.

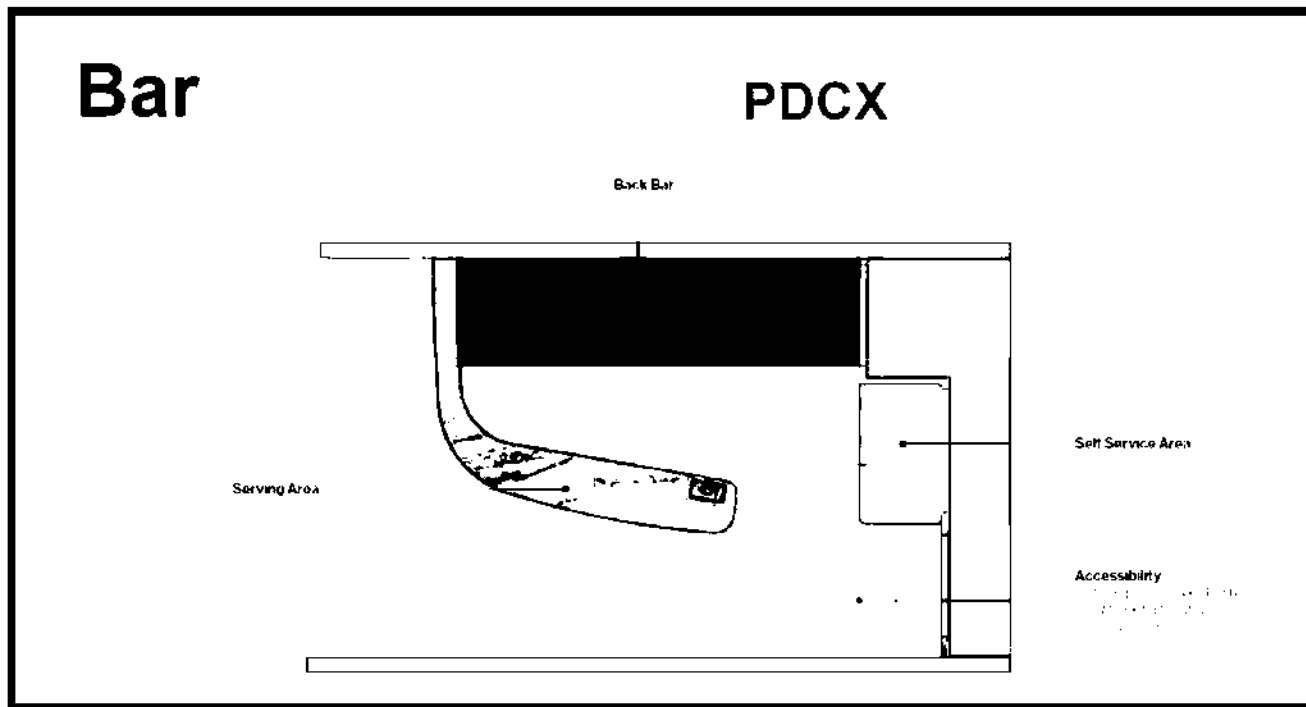

Figure 16-12: First Class Bar Layout - Top View

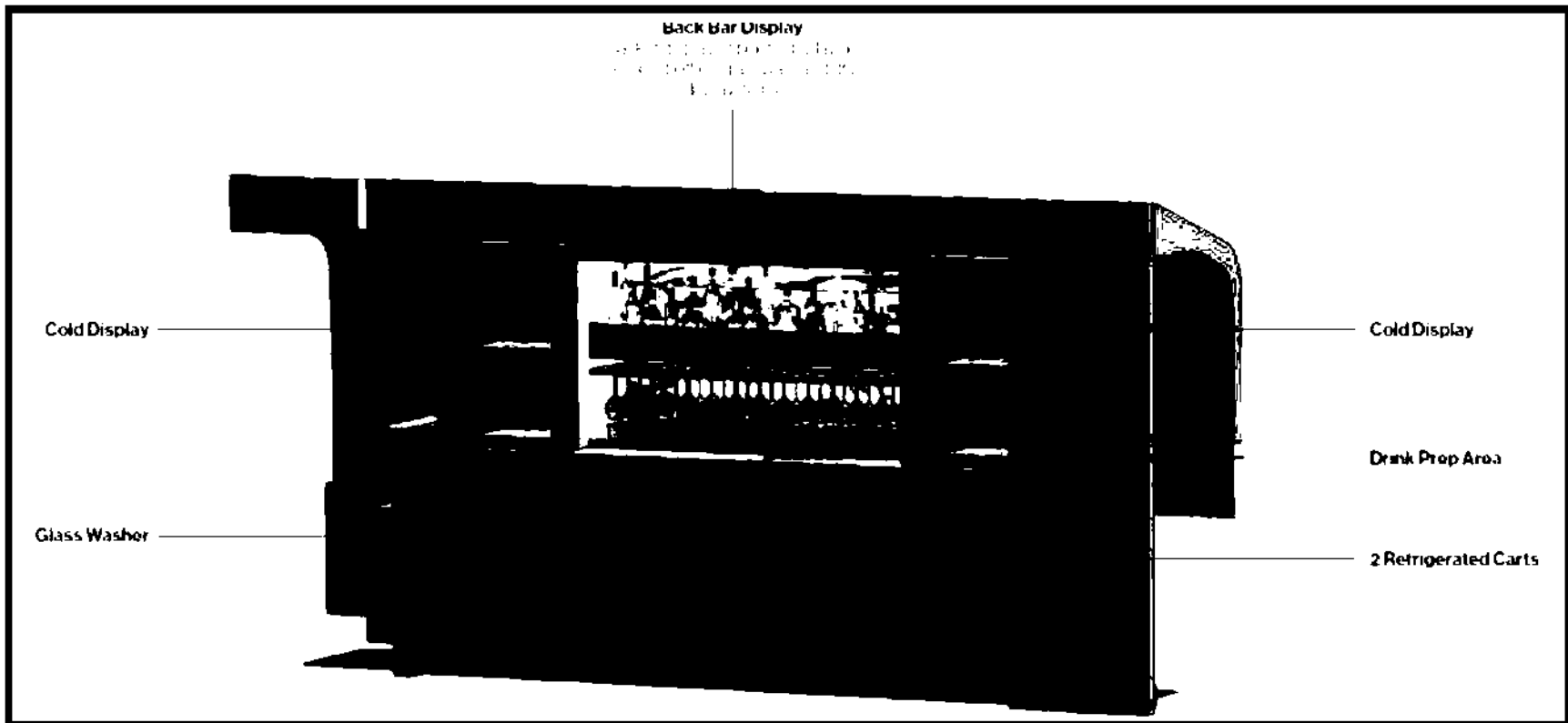

Figure 16-13: First Class Bar Layout - Elevation View 1

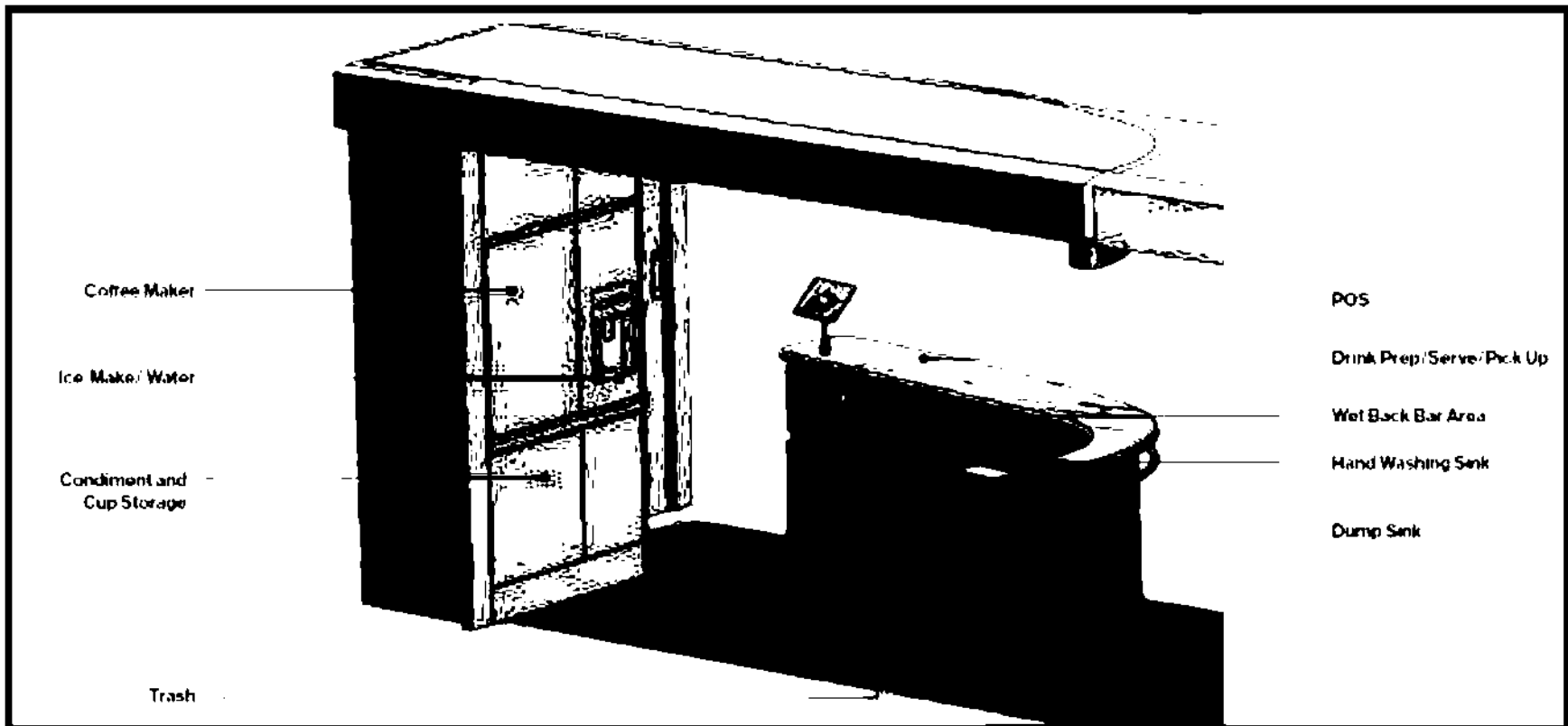

Figure 16-14: First Class Bar Layout - Elevation 2

c). Appliances

- i). Figure 16-15 lists the desired appliances along with an example part number and the quantity required within the First Class Lounge Bar food service area.
 - (1) Example part numbers are given to establish a starting place for appliance performance and will be finalized during the design reviews.
 - (2) The car builder will propose the exact manufacturer and part number for each appliance based on functionality, shock and vibration, service history, power requirements, and ability to meet crashworthiness requirements for mounting.
- ii). Detailed functional requirements for each appliance is listed below. In addition to these requirements, the Contractor shall factor in FDA cleaning clearances, radii, and sanitary design.
 - (1) Refrigerated Docking Station
 - (a) All features for the refrigerated docking station shall be identical to the refrigerated docking station described in the kitchen section 16.4.
 - (2) Refrigerated Cart
 - (a) All features for the refrigerated cart shall be identical to the refrigerated cart described in the kitchen section 16.4.
 - (3) Dishwasher
 - (a) All features for the dishwasher shall be identical to the dishwasher described in the kitchen section 16.4.
 - (4) Handwashing Sink
 - (a) All features for the handwashing sink shall be identical to the handwashing sink described in the kitchen section 16.4.
 - (5) Dump Sink
 - (a) Sink basin with manual faucet that is used for dumping partially consumed beverages before washing the beverage glass in the dishwasher.
 - (b) The dump sink shall include the same features as the handwashing sink, with the following exceptions:
 - (i) The sink basin shall be at least (6" x 6" x 6").
 - (ii) The faucet shall be manually operated.

- (iii) The soap dispenser and paper towel holders do not need to be supplied with the dump sink.

Figure 16-15: Appliance List - First Class Lounge Bar

Appliance	Description	Example Part Number	Quantity Desired
Refrigerated Cart Docking Station (2 cart)	2 cart docking station with cart chiller, cart sensor, temperature monitoring,	Stahl L002923	1
Refrigerated Cart	Insulated food cart with capability to maintain food temperature of 40 degrees F for one hour after loss of power	Bucher BA700036	2
Dishwasher	Dishwasher with 13 racks per hour capacity under heavy setting, holds standard size racks, 17" door opening, 0.62 gallons of water per rack, NSF rated high temperature,	Hobart LXeR advansys	1
Handwashing Sink	Sink basin with IR faucet for handwashing purposes, includes soap dispenser and paper towel holder mounting	-	1
Dump Sink	Sink basin with manual faucet that is used for dumping partially consumed beverages before washing the beverage glass in the dishwasher.	-	1
Trash and recycling Storage	Stainless steel module for storing removable trash and recycling bin. Trash and recycling bin is accessible through a drawer.	-	1
POS	Point of Sale machine for commercial transactions.	POS provided by Amtrak, provisions provided by Contractor	1
Storage Cabinets	Stainless steel cabinets or open shelving for dry storage to maximize space usage within food service area.	-	As space allows
Refrigerated Cabinets	Insulated refrigerator cabinet with ability to keep food goods between 32 and 40 degrees F	-	1
Countertop Workspace	Clear available workspace for food preparation with 6" backsplash and 0.25" radii.	-	As space allows
Coffee Maker	Twin coffee brewer with 1.5 gallon satellite servers,	Wilbur Curtis GEMTS16A-1000	1
Ice Maker	590 lb., 26" wide water cooled, cublet-nugget style ice machine and waster dispenser with bin, countertop mounting, 40lb bin ice storage	Hoshizaki DCM-500BWH	1

- (6) Trash and Recycling and Recycling Storage
 - (a) All features for the trash and recycling and recycling storage shall be identical to the trash and recycling and recycling storage described in the kitchen section 16.4, with the following exception:
 - (i) In this food service area, the cumulative minimum internal volume for the trash and recycling and recycling storage required is 8 cu ft. (36 in horizontal x 32 in tall x 12 in deep).
 - (b) This includes the features for the trash and recycling and recycling bin.
- (7) Point-of-Sale (POS)
 - (a) A Point-of-Sale unit will be provided by Amtrak in the food service area.
 - (b) All features for the POS interfaces shall be identical to the POS described in the Servery section 16.4.
- (8) Point of Sale System
 - (a) As an option, the carbuilder shall submit an option to provide a point of sale system as part of this contract.
 - (b) A Point of Sale (POS) system is a specialized computerized system that facilitates the processing and completion of retail transactions. It serves as the central hub where passengers make a payment for goods on-board the train.
 - (c) Hardware:
 - (i) Terminal/Checkout Counter: This is the physical location where the POS system is set up. It includes a computer terminal with a display, a barcode scanner, receipt printer, and a customer-facing display.
 - (ii) Barcode Scanner: Used to scan the barcodes on products, providing quick and accurate identification.
 - (iii) Card Reader: Allows customers to make electronic payments using credit or debit cards.
 - (iv) Cash Drawer: Safely stores cash received during transactions.
 - (v) Receipt Printer: Prints transaction receipts for customers.
 - (vi) Customer Display: A screen facing the customer that displays the items being rung up and the total cost.

- (d) Software:
 - (i) Point of Sale Application: The core software that manages and processes transactions. It includes a user interface for the crew to input items, calculate totals, and finalize sales.
 - (ii) Inventory Management: Tracks the quantity of products available for sale and updates inventory levels after each transaction.
 - (iii) Sales Reporting: Generates reports on sales, inventory, and other key metrics.
 - (iv) Employee Management: Manages user accounts and permissions.
 - (v) Payment Processing Integration: Links with payment gateways to process electronic transactions securely.
 - (vi) Security Features: Includes measures like user authentication, transaction encryption, and audit trails to ensure data security and integrity.

- (9) Storage Cabinet
 - (a) All features for the storage cabinet shall be identical to the storage cabinet described in the kitchen section 16.4, with the following exception:
 - (i) In this food service area, the cumulative minimum internal volume for the storage required is 37.2 cu ft:
 1. 24.6 cu ft. (45 in horizontal x 35 in tall x 27 in deep).
 2. Plus 12.6 cu ft. (32 in horizontal x 34 in tall x 20 in deep).

- (10) Refrigerated Cabinet
 - (a) All features for the refrigerated cabinet shall be identical to the refrigerated cabinet described in the kitchen section 16.4, with the following exceptions:
 - (i) In this food service area, the cumulative minimum internal volume for the refrigerated cabinets required is 18.8 cu ft. (48 in horizontal x 34 in tall x 20 in deep).
 - (ii) The doors for the refrigerated cabinet shall be made from clear safety glass so that the beverage selection is visible to the customer.
 - (iii) Shelving shall be static and adjustable to accommodate various beverage heights.

- (11) Countertop Workspace
 - (a) All features for the countertop workspace shall be identical to the countertop workspace described in the kitchen section 16.4, with the following exception:
 - (i) In this food service area, the minimum surface area for workspace required is 3.25 sq ft. (39 in horizontal x 12 in deep).
 - (12) Coffee Maker
 - (a) All features for the Coffee Maker shall be identical to the Coffee Maker described in the kitchen section 16.4.
 - (13) Ice Maker
 - (a) All features for the Ice Maker shall be identical to the Ice Maker described in the kitchen section 16.4.
- d). Functional Criteria
- i). The following items shall be reviewed with the criteria listed below for each.
 - ii). Sanitary Design Review Criteria
 - (1) Appropriate cleaning radii of at least 0.25" on worksurfaces and 0.75" on sink areas.
 - (2) Backsplashes of at least 6" on worksurfaces and sink areas.
 - (3) Appropriate cleaning clearances around appliances such that a 95th percentile male can fit their hand and a rag easily between objects for cleaning.
 - (4) All edges and seams are sealed with food grade silicone sealant and gaps greater than 1/32" are sealed in food storage, food preparation, and all other food related areas such as trash compartments shall be sealed in this manner.
 - (5) Floor drains are provided for locations prone to spills and leaks, especially near water piping to eliminate water pooling on the floor.
 - (6) Openings are protected from allowing pests and vermin to congregate
 - (7) Proper sealing methods are used to prevent moisture from corroding or otherwise damaging the food service area
 - (8) All drain pans and catches are accessible for cleaning
 - (9) No tools are required to move objects subject to daily cleaning rituals.

iii). Refrigeration and Freezer Equipment Review Criteria

(1) Temperature Monitoring System Functionality

- (a) Temperature monitoring shall be accomplished through a set of redundant sensors.
 - (i) The refrigeration controller shall relay temperatures for each of the refrigerated modules locally and in one location on a panel in the kitchen.
- (b) Additionally, temperatures shall be reported to wayside through the use of a PT100 sensor.
 - (i) The PT100 sensor and the controllers for the equipment shall be calibrated to ensure they are reporting the same temperature.
 - (ii) Temperatures shall be logged and accessible for at least a 6 month period of time after the date of data collection.
- (c) Temperatures for the refrigerated food carts shall be monitored in the ducting between the refrigerated docking station and the refrigerated cart.
 - (i) Industry standard is to monitor the temperature and combine 80% of the temperature for the return air and 20% for the supply air.
 - (ii) This calculation shall be used to determine the likely warmest temperature of the air in the food cart and shall inform the setpoint and need for temperature adjustment.
- (d) Temperatures for refrigerated cabinets shall be monitored directly in the refrigeration cabinet at the warmest temperature location and shall inform the setpoint and need for temperature adjustment.
- (e) Presently, Amtrak monitors the temperature of a refrigerated food cart by placing a yoghurt in the center of the cart and manually records the temperature of the yoghurt on an interval. If the yoghurt is out of temperature the food in the cart is considered out of temperature and therefore spoiled. The Contractor shall provide a system that consistently functions without allowing the yoghurt to test out of temperature and cause loss of revenue from spoiled goods.

(2) Type Tests

- (a) Type Tests for refrigeration and freezer systems shall be evaluated using ISO 23953-2 to determine the temperature probe location and validate performance of the system and

produce a test report for Amtrak's evaluation and approval as specified in ISO 23953-2 **[CDRL 16-03]**:

- (b) The following elements of design validation are of particular interest to Amtrak and shall be performed as type tests if information is not included in the ISO 23953-2 test report:
 - (i) Operational Temperature
 - 1. The system shall maintain food safe temperatures between 33°F to 40°F (1°C to 4°C) consistently for 8 hours.
 - 2. The freezer module will need to maintain temperature ranges below 0°F (-18°C) consistently for 8 hours.
 - 3. The supplier will propose a test to show the units maintain operational temperature under standard conditions:
 - a. 74.6°F (23.7°C) and 55% rH.
 - b. An allowable tolerance to this would be +/- 2 degrees F and +/- 5%.
 - 4. The refrigeration systems shall be suitably insulated to maintain the specified temperature limits during a power loss of 60 minutes to avoid condemning of perishable food products.
 - 5. The refrigeration system shall have real-time and remote temperature monitoring and alarm annunciation capabilities that shall alert onboard crew.
 - 6. The Contractor shall propose a test to show the units maintain operational temperature under standard conditions:
 - a. 74.6°F (23.7°C) and 55% rH.
 - b. An allowable tolerance to this would be +/- 2 degrees F and +/- 5%.
 - (ii) Probe Placement
 - 1. The temperature probe will need to be placed in the warmest location of the refrigerated compartment so that all food items stay within the acceptable temperature range.

(iii) Air Flow

1. The air flow through the module will need to be evaluated to ensure that there are no warm air pockets within the refrigerated compartment.

(iv) Operational Load Testing

1. The operational load of the refrigeration module needs to be evaluated to ensure that the refrigeration unit functions within the acceptable temperature range with simulated service loading conditions.
2. Amtrak will provide loading conditions prior to test procedure approval.
3. Three total tests will satisfy the operational load requirement: full load, half load, empty load. The operational temperature of the refrigeration system should maintain food safe temperatures.
4. The refrigeration module will need to maintain temperature ranges between 33°F to 40°F (1°C to 4°C) consistently for 8 hours.
5. The freezer module will need to maintain temperature ranges below 0°F (-18°C) consistently for 8 hours.
6. The Contractor shall propose a test to show the units maintain operational temperature under standard conditions:
 - a. 74.6°F (23.7°C) and 55% rH.
 - b. An allowable tolerance to this would be +/- 2 degrees F and +/- 5%.

(v) Condensation Evaluation

1. The refrigeration module, freezer, and chilled cart modules shall function with zero condensation on the outside surface of a module when exposed to the following environmental conditions:
 - a. 74.6°F (23.7°C) and 55% rH.
 - b. An allowable tolerance to this would be +/- 2 degrees F and +/- 5%. Zero condensation is defined as no fogging, beading, or dripping liquid on any outside surface of the module.

2. The Contractor shall perform a test to observe modules while they are functioning at the specified temperatures for 8 hours.
- (vi) Pull Down
1. The refrigeration and freezer modules are expected to pull down to temperature within 60 min with an inlet temperature of 70°F and repeated with inlet temperature of 110°F.
 2. The module will be completely empty for this test.
 3. The refrigeration unit shall reach a temperature range of 33-40°F within the specified time.
 4. The freezer unit shall reach a temperature of below 0°F within the specified time.
- e). Additional Equipment Requirements
- i). HVAC
- (1) Food service areas generate a large amount of ambient heat, smells, and humidity in the air; as a result, the HVAC system calculations must take into account the appliances and usage case of each food service area. Detailed HVAC requirement information can be found in Chapter 10, HVAC System.
 - (2) Bar Area Ventilation
 - (a) Ventilation to area in the bar shall include appliance generation of large amount of ambient heat, smells, and humidity in the air.
 - (b) The contribution of the bar to the heat load in the rest of the lounge car shall be evaluated.
 - (3) Appliance-Specific Ventilation
 - (a) Ventilation to specific appliances is required.
 - (b) This ventilation can come in the form of recycled air through the HVAC system or directly exhausting the outlet air for an appliance.
 - (c) The Contractor shall submit a proposal for which appliances listed below will be directly exhausted and provide all relevant calculations as justification.
 - (d) The submittal will be subject to Amtrak's review and approval during the design review process. **[CDRL 16-05]**

- (i) Refrigeration
 - 1. Refrigerated Docking Station
 - 2. Refrigerated Storage
- (ii) Freezer
- (iii) Other Appliances
 - 1. Dishwasher
 - 2. Coffee Maker
 - 3. Ice Maker
- ii). Electrical Equipment
 - (1) Electrical equipment information is shared in the points below. Detailed electrical requirements can be found in Chapter 15, Electrical System.
 - (2) Convenience Outlets
 - (a) Convenience Outlets shall be located during design reviews after discussion and approval from Amtrak.
 - (b) At least 2 duplex convenience outlets shall be located within the bar food service area.
 - (c) Only the convenience outlet near the attendant seat shall have USB ports.
 - (d) General purpose convenience outlets in these areas shall not have USB ports.
 - (3) Appliance Outlets
 - (a) Appliance Outlets shall be located directly behind a desired appliance.
 - (b) The outlets shall be properly sized and selected to safely power each appliance and the electrical system shall provide a dedicated breaker for each type of outlet.
 - (c) Appliance outlets shall not have USB ports.
 - (4) POS Outlet
 - (a) POS shall have an electrical circuit and dedicated breaker.
 - (b) The POS outlet shall have USB ports.
 - (c) The POS outlet must be available on car battery power and follow the battery load table 15-3: Power Phase Matrix.

iii). Lighting

- (1) Lighting general information is shared in the points below.
- (2) Detailed lighting information can be found in Chapter 13, Lighting System.
- (3) The points below are accompanied with diagram to show approximate lighting locations and types.
- (4) Overhead Lighting
 - (a) Overhead lighting shall be from flush mounted panel lights in the ceiling panels and/or from spotlights.
 - (b) Overhead lighting can be turned off if the car lighting mode is set to night mode.
 - (c) These overhead light fixtures cannot be required to meet FDA light intensity level requirements for food preparation counters, sinks, and workspaces.
- (5) Shelf Lighting
 - (a) Shelf lighting will be from surface mounted strip lights.
 - (b) These strip lights will be different brightness levels based on the area they are illuminating.
 - (c) Shelf lighting alone shall be the main source of illumination to meet FDA light intensity level requirements for food preparation counters, sinks, and workspaces.
 - (d) To illuminate a shelf, the shelf or underside of the top of the module above the shelf shall have a strip light mounted.
 - (e) To illuminate a workspace, the underside of the shelf above the workspace shall have a strip light mounted.
- (6) Display Case Lighting
 - (a) Display case lighting shall be lit from the sides of the display case and angle inward to illuminate the product inside of the display case.
- (7) Ambiance Lighting
 - (a) Ambiance lighting shall be provided as an option for Amtrak to exercise. Ambiance lighting is shown in the CMF documents.

iv). Communications Equipment

- (1) Communications equipment for the bar are described below. Detailed information regarding communications equipment can be found in Chapter 14, Communications.
- (2) PA Speakers
 - (a) PA speakers shall be located on the central ceiling panels of the bar.
 - (b) The speakers used in this location shall be identical to PA speakers used in other locations in the trainset for ease of maintenance and replacement.
- (3) PA Intercom
 - (a) PA Intercom shall be mounted near the ice maker in the bar area.
 - (b) This intercom shall be identical to the PA intercom used in other locations in the trainset for ease of maintenance and replacement.
- (4) Security Cameras
 - (a) Security Cameras shall be mounted to ceiling panels and shall give surveillance view of all areas of the bar for security, theft protection, and identification of possible hazards.
 - (b) At least 2 cameras shall be used to achieve this goal.
- (5) Smoke Detectors
 - (a) Smoke Detectors shall be mounted on the central ceiling panels of the bar.
 - (b) The smoke detectors used in this location shall be identical to the smoke detectors used in other locations in the trainset for ease of maintenance and replacement.
- v). Emergency Equipment
 - (1) The following emergency equipment pieces shall be included and stored in a conspicuous, accessible, and labeled location. Please refer to Chapter 18 Emergency Equipment for more information.
 - (a) Snap lights
 - (b) First aid kit
 - (c) Fire extinguisher
 - (d) AED

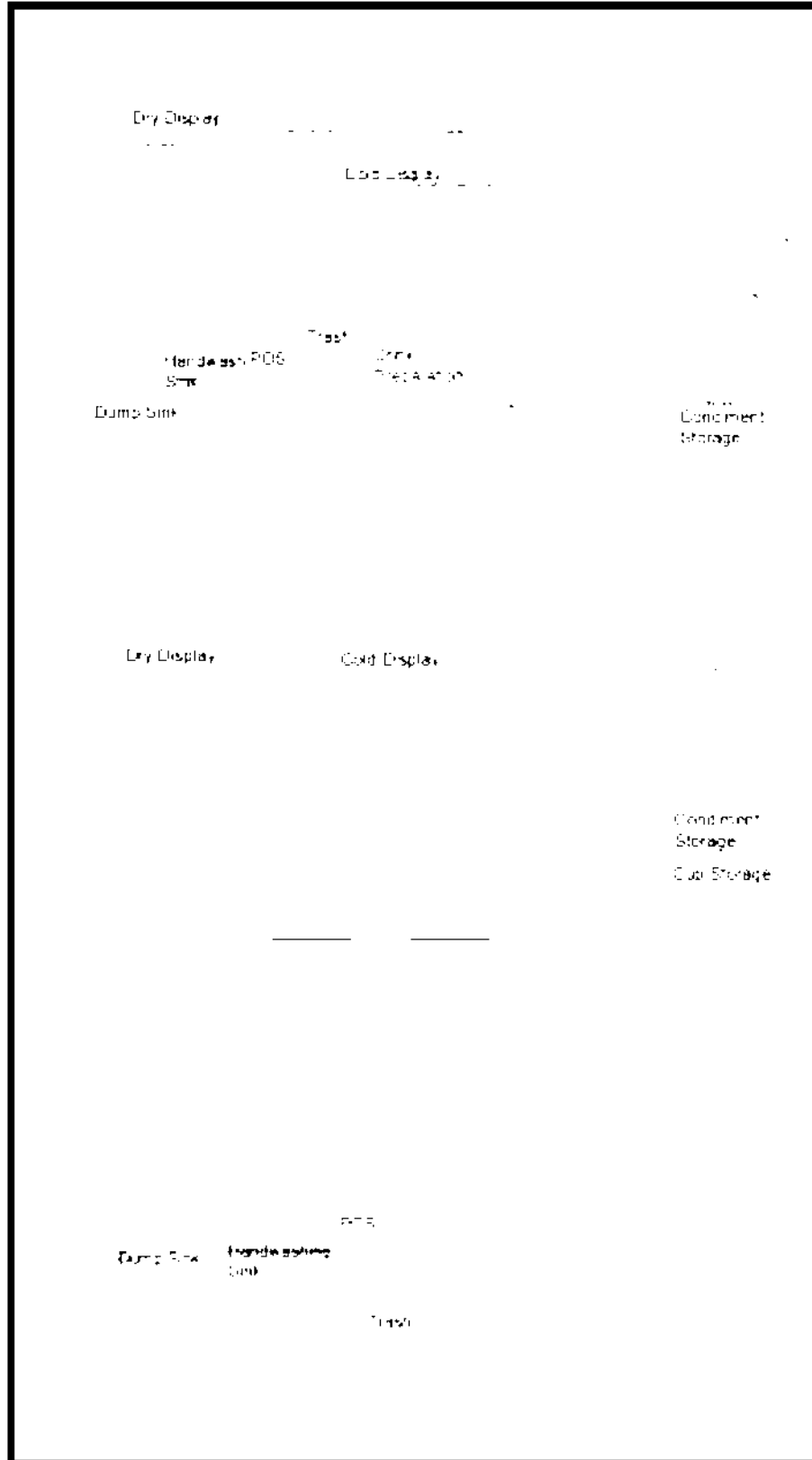

Figure 16-16: Bar Layout - Overhead, Display Case, and Strip Light General Locations

CONFIDENTIAL — DO NOT DISTRIBUTE

vi). Security

- (1) Many items within the food service area will need to be secured. The following items are identified with specific locking preferences. Any other locking or security items will be discussed with Amtrak during design reviews.
 - (a) Cart Locking
 - (i) The cart storage compartments shall include mechanisms that will lock the carts in the compartment as well as prevent the cart door from opening.
 - (ii) The locking mechanism shall use an Amtrak supplied padlock to secure the carriers.
 - (b) Cabinet Locking
 - (i) Cabinets shall include padlock hasps as determined with Amtrak during design reviews.
 - (ii) The locking mechanism shall use an Amtrak supplied padlock to secure the selected cabinets.
 - (c) Carrier Locking
 - (i) The carrier storage compartments shall include mechanisms that will lock the carriers in the compartment as well as prevent the carrier door from opening.
 - (ii) The locking mechanism shall use an Amtrak supplied padlock to secure the carriers.
 - (d) Refrigeration Cabinet Locking
 - (i) Refrigeration cabinets shall include padlock hasps as determined with Amtrak during design reviews.
 - (ii) The locking mechanism shall use an Amtrak supplied padlock to secure the selected cabinets.

vii). Countertop Heights

- (1) Countertop at point of sale shall be 42" maximum.
- (2) Countertop at ADA height shall be 36" maximum.

viii). Color Material and Finish (CMF)

- (1) Please refer to the attached CMF document for exact color, material, and finishes desired in this food service area.
- (2) Please also refer to Materials and Workmanship in Chapter 19.

- (3) General expectations are listed below.
- (4) CMF will be finalized with Amtrak after the mockup review.
 - (a) Stainless Steel Modules
 - (i) Stainless Steel Modules shall be created from sheet metal that is sized to prevent denting, oil canning, or otherwise non-sturdy structures.
 - (ii) The modules shall be constructed from 304 stainless-steel with a #4 finish (320 grit) or as approved during design reviews with Amtrak.
 - (b) Carshell Walls
 - (i) Carshell walls shall be lined to create interior walls for the bar. Sidewall liners shall be made from molded thermoplastic with an easy to clean surface finish.
 - (c) Partition Walls
 - (i) Partition Walls shall be created from a composite structure such as aluminum honeycomb or HPL skinned honeycomb panels.
 - (ii) The finish of the wall and material of the outside skin shall be inspired by the CMF document and meet all structural requirements for crashworthiness based on mounting and attached loads to the panel.
 - (d) Ceiling Panels
 - (i) Ceiling Panels shall be created from a composite structure such as aluminum honeycomb or HPL skinned honeycomb panels.
 - (ii) The finish of the passenger facing side of the ceiling panel and material of the outside skin shall be inspired by the CMF document and meet all structural requirements for crashworthiness based on mounting and attached loads to the panel.
 - (iii) The finish of the material on the non-passenger facing side shall be coated such that there is no risk of corrosion from moisture from steam or humidity within the car.
 - (e) First Class Bar Countertops
 - (i) Countertops within the first class bar area shall all be made from solid surface material on the high level and from stainless-steel on the LSA workstation level.

- (f) Bar Area Flooring
 - (i) Flooring within the bar area shall be made from rubber flooring with a friction, no-slip texture.
 - (ii) Flooring will be durable to withstand spills, leaks, and all methods of cleaning.
 - (iii) Flooring shall also not become frequently damaged or worn by cart movement or by kitchen staff standing in specific locations.
 - (iv) Flooring shall have enough give to prevent fatigue from standing.

16.7 Café

a). Vision

- i). The café provides an opportunity for passengers to purchase refreshments on board Amtrak long distance, however it also provides a chance to stretch legs and explore new surroundings. In this way it is a focal destination as well as a functional space.
- ii). The café should have a large, open and continuous counter at an accessible height. This highly visible area should have a passenger friendly aesthetic, including behind the counter and back of house area.
- iii). The back of house areas closest and most visible to the customers' ordering and queuing areas should be well considered with a premium aesthetic and in a format that encourages sales at point of purchase. – for example - Visual merchandising and food display is placed front and center, whereas unsightly commercial storage and kitchen equipment should be, where possible, hidden from view and located towards the rear of the café, on the inside wall, or under counter height.
- iv). Externally the café should have a bold geometric outline with counters and wall finishes conveying the aesthetic of a contemporary café or coffee house.
- v). Lighting will play a huge part in the ambiance of the Café and should contain a feature light to make the space an enticing destination for our Coach customers.
- vi). Digital menu screens linked to live data should display up to date menus, promotions, and general information. These should be placed at queuing points and at point of purchase.
- vii). A space should be reserved on the outside wall of the Café for branding.
- viii). The counter should be kept clear of equipment to allow for future food service opportunities such as a 'grab and go' location.

- ix). The design of the back of house should be future ready – The design of this area should be considered as modular so that equipment can be upgraded or changed as service models evolve over time.
- b). **Desired Layout**
 - i). The layout in the figures below shows the desired approximate locations and relative footprints for each element of the café from an ergonomic and preparation flow perspective.
 - (1) The Contractor shall use this layout as the basis for the café design and make adjustments as necessary to provide complete functionality.
 - (2) The final layouts will be approved by Amtrak during the design review process.
 - (3) Note the numbers in the figures below correlate to the numbers in 16.6) c) ii). of this section.
- c). **Appliances**
 - i). Figure 16-20 lists the desired appliances along with an example part number and the quantity required within the café food service area.
 - ii). Note that example part numbers are given to establish a starting place for appliance performance and will be finalized during the design reviews.
 - iii). The car builder will propose the exact manufacturer and part number for each appliance based on functionality, shock and vibration, service history, power requirements, and ability to meet crashworthiness requirements for mounting.

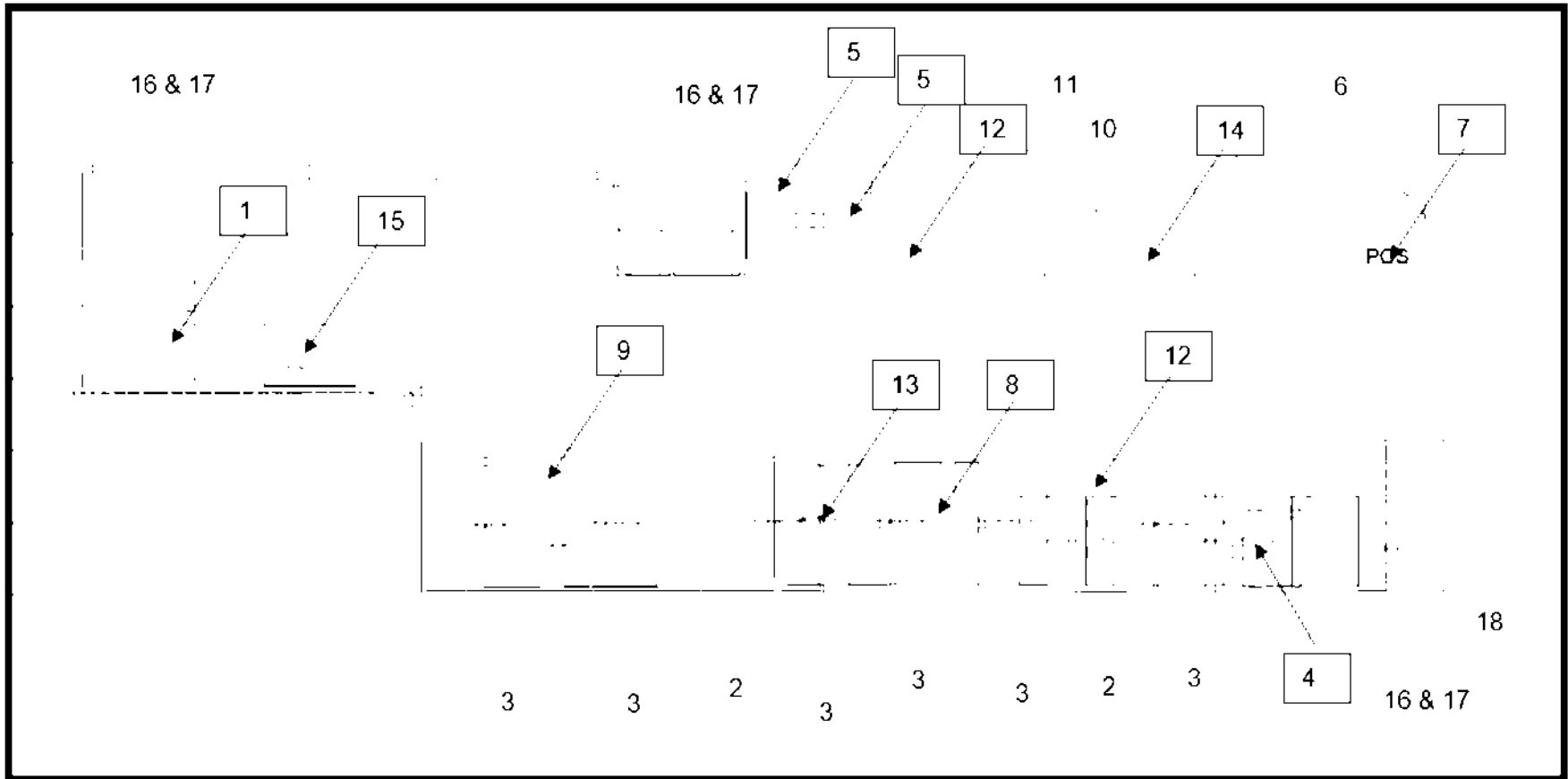

Figure 16-17: Cafe Layout - Top View

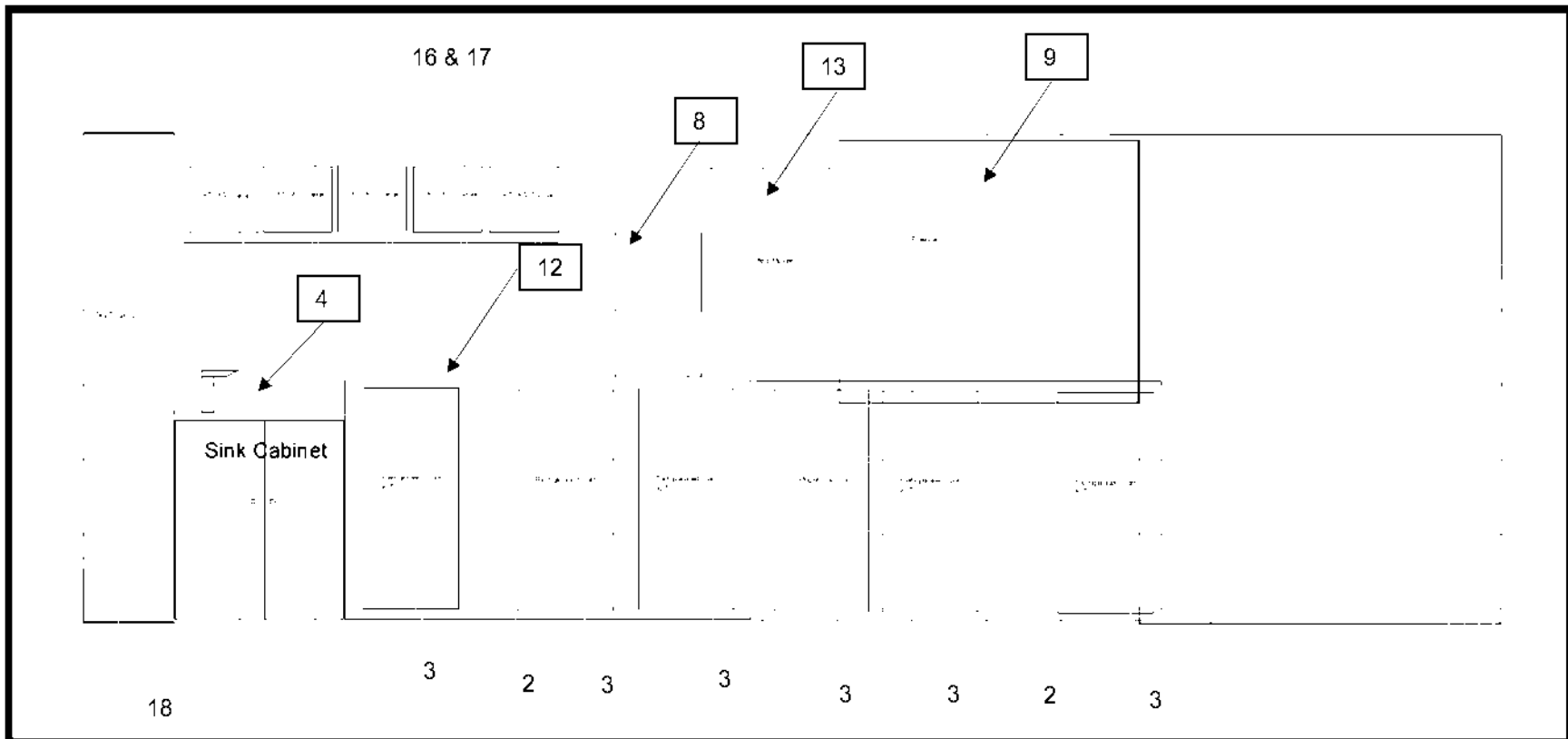

Figure 16-18: Cafe Layout - Elevation View 1

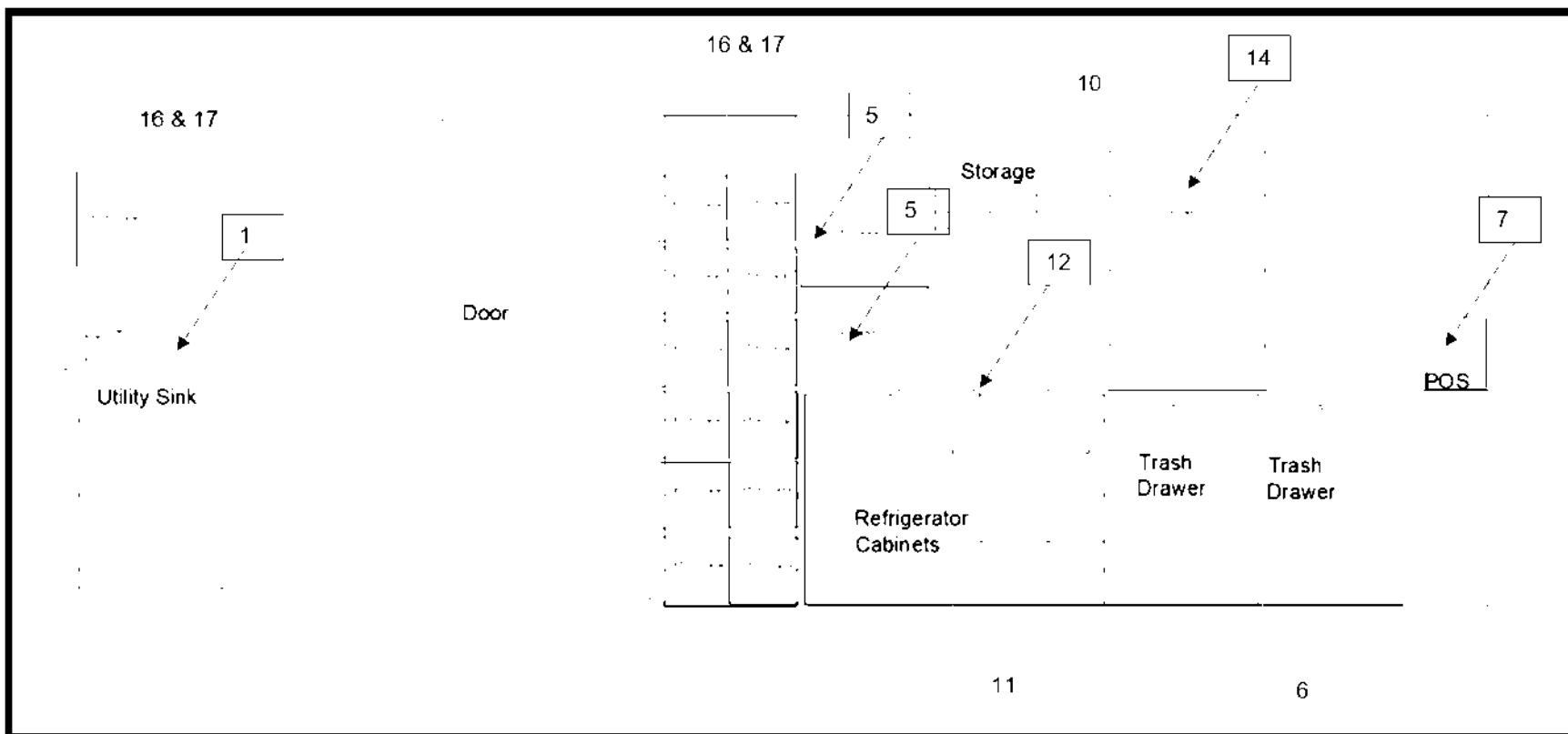

Figure 16-19: Cafe Layout - Elevation View 2

Figure 16-20: Appliance List - Café

Appliance	Description	Example Part Number	Quantity Desired
Utility Sink	This is a 3-compartment sink used for washing food preparation and storage items.	-	1
Refrigerated Cart Docking Station (3 cart)	3 cart docking station with cart chiller, cart sensor, temperature monitoring,	Stahl L002923	2
Refrigerated Cart	Insulated food cart with capability to maintain food temperature of 40 degrees F for one hour after loss of power	Bucher BA700036	6
Handwashing Sink	Sink basin with IR faucet for handwashing purposes, includes soap dispenser and paper towel holder mounting.	-	1
Microwave	Countertop stackable microwave, 0.6 cu ft capacity, 2100 watts, heavy volume, 4 stage cooking, touchscreen	Amana HDC212	2
Trash and Recycling Storage	Stainless steel module for storing removable trash and recycling bin. Trash and recycling bin is accessible through a drawer.	-	1
POS	Point of Sale machine for commercial transactions. POS provided by Amtrak, provisions provided by Contractor	-	1
Rapid Cook Oven	0.54 cu ft capacity, ventless, cool touch exterior, touch control	TurboChef ECO ST	1
Freezer	Insulated freezer cabinet with ability to keep food goods at or below 0 degrees F.	-	1
Storage Cabinets	Stainless steel cabinets or open shelving for dry storage to maximize space usage within food service area.	-	As space allows
Refrigerated Cabinets	Insulated refrigerator cabinet with ability to keep food goods between 32 and 40 degrees F	-	1
Countertop Workspace	Clear available workspace for food preparation with 6" backsplash and 0.25" radii.	-	As space allows
Coffee Maker	Twin coffee brewer with 1.5 gallon satellite servers,	Wilbur Curtis GEMTS16A-1000	1
Ice Maker	590 lb., 26" wide water cooled, cublet-nugget style ice machine and waster dispenser with bin, countertop mounting, 40lb bin ice storage	Hoshizaki DCM-500BWH	1
LSA Seat	A tip down seat for the LSA to rest during breaks. This seat shall be capable of supporting 300lbs downward force in all loading conditions.	-	1

Appliance	Description	Example Part Number	Quantity Desired
ATLAS Carrier Storage	Stainless steel cubbies for ATLAS Carrier storage to maximize space usage within food service area.	-	3
ATLAS Carriers	Atlas sized dry goods container for storage and transport of goods between commissary and food service area	Bucher BA740012	19
Dry Goods Display Case	A display case for dry goods to be displayed near the POS for customers to grab at checkout. The display case shall have retention bars on the front end of each shelf, built in lighting for the product display area, and be capable of being loaded from the inside of the café.	-	1

- iv). Detailed functional requirements for each appliance is listed below. In addition to these requirements, the Contractor shall factor in FDA cleaning clearances, radii, and sanitary design.
 - (1) Utility Sink
 - (a) A three-compartment sink shall be provided where each sink basin is at least (9" x 12" x 8").
 - (b) All other features of the utility sink shall be identical to the utility sink described in the kitchen section 16.4.
 - (2) Refrigerated Docking Station
 - (a) All features for the refrigerated docking station shall be identical to the refrigerated docking station described in the kitchen section 16.4, with the following exception:
 - (i) 3 carts shall be docked in the café docking stations.
 - (3) Refrigerated Cart
 - (a) All features for the refrigerated cart shall be identical to the refrigerated cart described in the kitchen section 16.4.
 - (4) Handwashing Sink
 - (a) All features for the handwashing sink shall be identical to the handwashing sink described in the kitchen section 16.4.
 - (5) Microwave
 - (a) a purchased off the shelf item that meets or exceeds the features from the example part number. Example part number listed as Amana HDC212.
 - (i) Countertop stackable microwave,
 - (ii) 0.6 cu ft capacity, 2100 watts,
 - (iii) heavy volume,
 - (iv) 4 stage cooking,
 - (v) Touchscreen
 - (vi) A spare microwave shall be provided in storage in the event of failure

- (6) Trash and Recycling Storage
 - (a) All features for the trash and recycling storage shall be identical to the trash and recycling storage described in the kitchen section 16.4, with the following exception:
 - (i) In this food service area, the cumulative minimum internal volume for the storage required is 20.2 cu ft. (50 in horizontal x 35 in tall x 20 in deep).
 - (b) This includes the features for the trash and recycling bin.
- (7) Point-of-Sale (POS)
 - (a) A Point-of-Sale unit will be provided by Amtrak in the food service area.
 - (b) All features for the POS interfaces shall be identical to the POS described in the Servery Section 16.5.
- (8) Point of Sale System
 - (a) As an option, the carbuilder shall submit an option to provide a point of sale system as part of this contract.
 - (b) A Point of Sale (POS) system is a specialized computerized system that facilitates the processing and completion of retail transactions. It serves as the central hub where passengers make a payment for goods on-board the train.
 - (c) Hardware:
 - (i) Terminal/Checkout Counter: This is the physical location where the POS system is set up. It includes a computer terminal with a display, a barcode scanner, receipt printer, and a customer-facing display.
 - (ii) Barcode Scanner: Used to scan the barcodes on products, providing quick and accurate identification.
 - (iii) Card Reader: Allows customers to make electronic payments using credit or debit cards.
 - (iv) Cash Drawer: Safely stores cash received during transactions.
 - (v) Receipt Printer: Prints transaction receipts for customers.
 - (vi) Customer Display: A screen facing the customer that displays the items being rung up and the total cost.
 - (d) Software:

- (i) Point of Sale Application: The core software that manages and processes transactions. It includes a user interface for the crew to input items, calculate totals, and finalize sales.
 - (ii) Inventory Management: Tracks the quantity of products available for sale and updates inventory levels after each transaction.
 - (iii) Sales Reporting: Generates reports on sales, inventory, and other key metrics.
 - (iv) Employee Management: Manages user accounts and permissions.
 - (v) Payment Processing Integration: Links with payment gateways to process electronic transactions securely.
 - (vi) Security Features: Includes measures like user authentication, transaction encryption, and audit trails to ensure data security and integrity.
- (9) Rapid Cook Oven
- (a) A purchased off the shelf item that meets or exceeds the features from the example part number. Example part number listed as TurboChef ECO ST.
 - (i) 0.54 cu ft capacity,
 - (ii) ventless,
 - (iii) cool touch exterior,
 - (iv) touch control
- (10) Freezer
- (a) All features for the freezer shall be identical to the freezer described in the kitchen section 16.4, with the following exceptions:
 - (i) In this food service area, the cumulative minimum internal volume for each freezer required is 9 cu ft. (24 in horizontal x 36 in tall x 18 in deep).
 - (ii) Two adjustable shelves that can only be removed with tools at a maintenance station shall be included.
- (11) Storage Cabinet
- (a) All features for the storage cabinet shall be identical to the storage cabinet described in the kitchen section 16.4, with the following exception:

- (i) In this food service area, the cumulative minimum internal volume for the storage required is 6.25 cu ft. (27 in horizontal x 20 in tall x 20 in deep).
- (12) Refrigerated Cabinet
 - (a) All features for the refrigerated cabinet shall be identical to the refrigerated cabinet described in the kitchen section 16.4, with the following exception:
 - (i) In this food service area, the cumulative minimum internal volume for the refrigerated cabinets required is 11.5 cu ft. (46 in horizontal x 31 in tall x 14 in deep)
- (13) Countertop Workspace
 - (a) All features for the countertop workspace shall be identical to the countertop workspace described in the kitchen section 16.4, with the following exception:
 - (i) In this food service area, the minimum surface area for workspace required is 23.75 sq ft. (90 in horizontal x 38 in deep).
- (14) Coffee Maker
 - (a) All features for the Coffee Maker shall be identical to the Coffee Maker described in the kitchen section 16.3.
- (15) Ice Maker
 - (a) All features for the Ice Maker shall be identical to the Ice Maker described in the kitchen section 16.4.
- (16) LSA Seat
 - (a) A tip down seat for the LSA to rest during breaks.
 - (b) This seat shall be capable of supporting 300lbs downward force in all loading conditions.
- (17) ATLAS Carrier Storage
 - (a) All features for the ATLAS carrier storage shall be identical to the ATLAS carrier storage described in the kitchen section 16.4.
- (18) ATLAS Carrier
 - (a) All features for the ATLAS carrier shall be identical to the ATLAS carrier described in the kitchen section 16.4.

(19) Dry Goods Display Case

- (a) A display case for dry goods to be displayed near the POS for customers to grab at checkout.
- (b) The display case shall have retention bars on the front end of each shelf, built in lighting for the product display area, and be capable of being loaded from the inside of the café.
- (c) The specific aesthetic for this display area shall be developed with Amtrak during the design review process and will be inspired by the CMF document attached to this specification.
- (d) The rest of the mechanical structure requirements for the dry goods display case shall be identical to the storage cabinet described in the kitchen section 16.4, with the following exception:
 - (i) In this food service area, the cumulative minimum internal volume for the storage required is 24 cu ft. (104 in horizontal x 20 in tall x 20 in deep).

d). Functional Criteria

- i). The following items shall be reviewed with the criteria listed below for each.
- ii). Sanitary Design Review Criteria
 - (1) Appropriate cleaning radii of at least 0.25" on worksurfaces and 0.75" on sink areas.
 - (2) Backsplashes of at least 6" on worksurfaces and sink areas.
 - (3) Appropriate cleaning clearances around appliances such that a 95th percentile male can fit their hand and a rag easily between objects for cleaning.
 - (4) All edges and seams are sealed with food grade silicone sealant and gaps greater than 1/32" are sealed in food storage, food preparation, and all other food related areas such as trash compartments shall be sealed in this manner.
 - (5) Floor drains are provided for locations prone to spills and leaks, especially near water piping to eliminate water pooling on the floor.
 - (6) Openings are protected from allowing pests and vermin to congregate
 - (7) Proper sealing methods are used to prevent moisture from corroding or otherwise damaging the food service area
 - (8) All drain pans and catches are accessible for cleaning
 - (9) No tools are required to move objects subject to daily cleaning rituals

- iii). Refrigeration and Freezer Equipment Review Criteria
 - (1) Temperature monitoring system functionality
 - (a) Temperature monitoring shall be accomplished through a set of redundant sensors.
 - (i) The refrigeration controller shall relay temperatures for each of the refrigerated modules locally and in one location on a panel in the kitchen.
 - (b) Additionally, temperatures shall be reported to wayside through the use of a PT100 sensor.
 - (i) The PT100 sensor and the controllers for the equipment shall be calibrated to ensure they are reporting the same temperature.
 - (ii) Temperatures shall be logged and accessible for at least a 6 month period of time after the date of data collection.
 - (c) Temperatures for the refrigerated food carts shall be monitored in the ducting between the refrigerated docking station and the refrigerated cart.
 - (i) Industry standard is to monitor the temperature and combine 80% of the temperature for the return air and 20% for the supply air.
 - (ii) This calculation shall be used to determine the likely warmest temperature of the air in the food cart and shall inform the setpoint and need for temperature adjustment.
 - (d) Temperatures for refrigerated cabinets shall be monitored directly in the refrigeration cabinet at the warmest temperature location and shall inform the setpoint and need for temperature adjustment.
 - (e) Presently, Amtrak monitors the temperature of a refrigerated food cart by placing a yoghurt in the center of the cart and manually records the temperature of the yoghurt on an interval. If the yoghurt is out of temperature the food in the cart is considered out of temperature and therefore spoiled. The Contractor shall provide a system that consistently functions without allowing the yoghurt to test out of temperature and cause loss of revenue from spoiled goods.
 - (2) Type Tests
 - (a) Type Tests for refrigeration and freezer systems shall be evaluated using ISO 23953-2 to determine the temperature probe location and validate performance of the system and

produce a test report for Amtrak's evaluation and approval as specified in ISO 23953-2 **[CDRL 16-03]**:

- (b) The following elements of design validation are of particular interest to Amtrak and shall be performed as type tests if information is not included in the ISO 23953-2 test report:
 - (i) Operational Temperature
 - 1. The system shall maintain food safe temperatures between 33°F to 40°F (1°C to 4°C) consistently for 8 hours.
 - 2. The freezer module will need to maintain temperature ranges below 0°F (-18°C) consistently for 8 hours.
 - 3. The supplier will propose a test to show the units maintain operational temperature under standard conditions:
 - a. 74.6°F (23.7°C) and 55% rH.
 - b. An allowable tolerance to this would be +/- 2 degrees F and +/- 5%.
 - 4. The refrigeration systems shall be suitably insulated to maintain the specified temperature limits during a power loss of 60 minutes to avoid condemning of perishable food products.
 - 5. The refrigeration system shall have real-time and remote temperature monitoring and alarm annunciation capabilities that shall alert onboard crew.
 - 6. The Contractor shall propose a test to show the units maintain operational temperature under standard conditions:
 - a. 74.6°F (23.7°C) and 55% rH.
 - b. An allowable tolerance to this would be +/- 2 degrees F and +/- 5%.
 - (ii) Probe Placement
 - 1. The temperature probe will need to be placed in the warmest location of the refrigerated compartment so that all food items stay within the acceptable temperature range.

(iii) Air Flow

1. The air flow through the module will need to be evaluated to ensure that there are no warm air pockets within the refrigerated compartment.

(iv) Operational Load Testing

1. The operational load of the refrigeration module needs to be evaluated to ensure that the refrigeration unit functions within the acceptable temperature range with simulated service loading conditions.
2. Amtrak will provide loading conditions prior to test procedure approval.
3. Three total tests will satisfy the operational load requirement: full load, half load, empty load. The operational temperature of the refrigeration system should maintain food safe temperatures.
4. The refrigeration module will need to maintain temperature ranges between 33°F to 40°F (1°C to 4°C) consistently for 8 hours.
5. The freezer module will need to maintain temperature ranges below 0°F (-18°C) consistently for 8 hours.
6. The Contractor shall propose a test to show the units maintain operational temperature under standard conditions:
 - a. 74.6°F (23.7°C) and 55% rH.
 - b. An allowable tolerance to this would be +/- 2 degrees F and +/- 5%.

(v) Condensation Evaluation

1. The refrigeration module, freezer, and chilled cart modules shall function with zero condensation on the outside surface of a module when exposed to the following environmental conditions:
 - a. 74.6°F (23.7°C) and 55% rH.
 - b. An allowable tolerance to this would be +/- 2 degrees F and +/- 5%.
 - c. Zero condensation is defined as no fogging, beading, or dripping liquid on any outside surface of the module.

2. The Contractor shall perform a test to observe modules while they are functioning at the specified temperatures for 8 hours.
- (vi) Pull Down
1. The refrigeration and freezer modules are expected to pull down to temperature within 60 min with an inlet temperature of 70°F and repeated with inlet temperature of 110°F.
 2. The module will be completely empty for this test.
 3. The refrigeration unit shall reach a temperature range of 33-40°F within the specified time.
 4. The freezer unit shall reach a temperature of below 0°F within the specified time.
- e). Additional Equipment Requirements
- i). HVAC
 - ii). Food service areas generate a large amount of ambient heat, smells, and humidity in the air; as a result, the HVAC system calculations must take into account the appliances and usage case of each food service area. Detailed HVAC requirement information can be found in Chapter 10, HVAC System.
 - (1) Café Area Ventilation
 - (a) Ventilation to area in the cafe shall include appliance generation of large amount of ambient heat, smells, and humidity in the air.
 - (b) HVAC shall be separately controlled for the cafe for mitigation of the issues listed above and for staff comfort.
 - (2) Appliance-Specific Ventilation
 - (a) Ventilation to specific appliances is required.
 - (b) This ventilation can come in the form of recycled air through the HVAC system or directly exhausting the outlet air for an appliance.
 - (c) The Contractor shall submit a proposal for which appliances listed below will be directly exhausted and provide all relevant calculations as justification.
 - (d) The submittal will be subject to Amtrak's review and approval during the design review process. **[CDRL 16-05]**

1. Rapid Cook Ovens
 2. Microwave Ovens
 - (ii) Refrigeration
 1. Refrigerated Docking Station
 2. Refrigerated Storage
 - (iii) Freezer
 - (iv) Other Appliances
 1. Coffee Maker
 2. Ice Maker
- iii). Electrical Equipment
 - (1) Electrical equipment information is shared in the points below. Detailed electrical requirements can be found in Chapter 15, Electrical System.
 - (2) Convenience Outlets
 - (a) Convenience Outlets shall be located during design reviews after discussion and approval from Amtrak.
 - (b) At least 8 duplex convenience outlets shall be located within the café food service area.
 - (c) Only the convenience outlet near the attendant seat shall have USB ports.
 - (d) General purpose convenience outlets in these areas shall not have USB ports.
 - (3) Appliance Outlets
 - (a) Appliance Outlets shall be located directly behind a desired appliance.
 - (b) The outlets shall be properly sized and selected to safely power each appliance and the electrical system shall provide a dedicated breaker for each type of outlet.
 - (c) Appliance outlets shall not have USB ports.
 - (4) POS Outlet
 - (a) POS shall have an electrical circuit and dedicated breaker.
 - (b) The POS outlet shall have USB ports.

- (c) The POS outlet must be available on car battery power and follow the battery load table 15-3: Power Phase Matrix.
- iv). Lighting
- (1) Lighting general information is shared in the points below.
 - (2) Detailed lighting information can be found in Chapter 13, Lighting System.
 - (3) Each point below is accompanied with a small diagram to show approximate lighting locations and types.
 - (4) Overhead Lighting
 - (a) Overhead lighting shall be from flush mounted panel lights in the ceiling panels and/or from spotlights.
 - (b) Overhead lighting can be turned off if the car lighting mode is set to night mode.
 - (c) These overhead light fixtures cannot be required to meet FDA light intensity level requirements for food preparation counters, sinks, and workspaces.
 - (5) Shelf Lighting
 - (a) Shelf lighting will be from surface mounted strip lights. These strip lights will be different brightness levels based on the area they are illuminating.
 - (b) Shelf lighting alone shall be the main source of illumination to meet FDA light intensity level requirements for food preparation counters, sinks, and workspaces.
 - (c) To illuminate a shelf, the shelf or underside of the top of the module above the shelf shall have a strip light mounted.
 - (d) To illuminate a workspace, the underside of the shelf above the workspace shall have a strip light mounted.
 - (6) Display Case Lighting
 - (a) Display case lighting shall be lit from the sides of the display case and angle inward to illuminate the product inside of the display case.
 - (7) Ambiance Lighting
 - (a) Ambiance lighting shall be provided as an option for Amtrak to exercise. Ambiance lighting is shown in the CMF documents.

- v). Communications Equipment
 - (1) Communications equipment for the café are described below.
 - (2) Detailed information regarding communications equipment can be found in Chapter 14, Communications.
 - (3) PA Speakers
 - (a) PA speakers shall be located on the ceiling panels at both ends of the café.
 - (b) The speakers used in this location shall be identical to PA speakers used in other locations in the trainset for ease of maintenance and replacement.
 - (4) PA Intercom
 - (a) PA Intercom shall be mounted near the entrance door of the café.
 - (b) This intercom shall be identical to the PA intercom used in other locations in the trainset for ease of maintenance and replacement.
 - (5) Security Cameras
 - (a) Security Cameras shall be mounted to ceiling panels and shall give surveillance view of all areas of the cafe for security, theft protection, and identification of possible hazards.
 - (b) At least 3 cameras shall be used to achieve this goal.
 - (6) Smoke Detectors
 - (a) Smoke Detectors shall be mounted on the ceiling panels at both ends of the café.
 - (b) The smoke detectors used in this location shall be identical to the smoke detectors used in other locations in the trainset for ease of maintenance and replacement.
- vi). Emergency Equipment
 - (1) The following emergency equipment pieces shall be included and stored in a conspicuous, accessible, and labeled location. Please refer to Chapter 18 Emergency Equipment for more information.
 - (a) Snap lights
 - (b) First aid kit
 - (c) Fire extinguisher

- (d) AED
- vii). Security
 - (1) Many items within the food service area will need to be secured. The following items are identified with specific locking preferences. Any other locking or security items will be discussed with Amtrak during design reviews.
 - (a) Door
 - (i) The lock in the galley door shall utilize a JL Howard Amtrak crew key for access from the outside.
 - (ii) Egress shall be accomplished with a thumb turn latch.
 - (b) Cart Locking
 - (i) The cart storage compartments shall include mechanisms that will lock the carts in the compartment as well as prevent the cart door from opening.
 - (ii) The locking mechanism shall use an Amtrak supplied padlock to secure the carriers.
 - (c) Cabinet Locking
 - (i) Cabinets shall include padlock hasps as determined with Amtrak during design reviews.
 - (ii) The locking mechanism shall use an Amtrak supplied padlock to secure the selected cabinets.
 - (d) Carrier Locking
 - (i) The carrier storage compartments shall include mechanisms that will lock the carriers in the compartment as well as prevent the carrier door from opening.
 - (ii) The locking mechanism shall use an Amtrak supplied padlock to secure the carriers.
 - (e) Refrigeration Cabinet Locking
 - (i) Refrigeration cabinets shall include padlock hasps as determined with Amtrak during design reviews.
 - (ii) The locking mechanism shall use an Amtrak supplied padlock to secure the selected cabinets.